

Jabra PanaCast

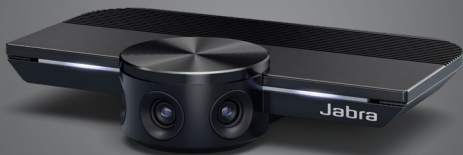

User manual

© 2019 GN Audio A/S. All rights reserved. Jabra® is a trademark of GN Audio A/S.

Made in China
MODEL: VSU010



Declaration of Conformity can be found on
www.jabra.com/doc

1. Welcome.....	5
2. Overview.....	6
2.1 Jabra PanaCast overview	
2.2 Accessories	
3. Camera setup.....	8
3.1 Wall mount	
3.2 Table stand	
3.3 Powering the camera	
3.4 Typical room configuration	
3.5 Typical room configuration (using the optional Jabra PanaCast Hub)	
4. How to use.....	13
4.1 Supported operating systems	
4.2 Compatible video conferencing applications	
4.3 Connect your computer to the Jabra PanaCast camera	
4.4 Connect your computer to the optional Jabra PanaCast Hub	
4.5 What the camera LEDs mean	
4.6 Using the camera with Microsoft Teams	
4.7 Using the camera with Skype for Business	
4.8 Using the camera with other compatible video conferencing applications	

5. Camera features	19
5.1 Intelligent Zoom	
5.2 Vivid HDR	
5.3 Video adjustments	
5.4 Field of view	
5.5 Camera orientation	
5.6 Built-in microphones	
6. Software	22
6.1 Jabra Direct (Windows or macOS)	
6.2 Update firmware	
7. Support	23
7.1 FAQ and technical specifications	
7.2 How to care for your Jabra device	

1. Welcome

Thank you for using the Jabra PanaCast. We hope you will enjoy it!

Jabra PanaCast features

- **Inclusive meetings.** Panoramic-4K video using three 13-megapixel cameras and patented real-time video stitching to give 180° coverage, for a more natural view of the huddle room. The perfect partner for rich Jabra Speak audio.
- **Intelligent video technology.** Intelligent Zoom automatically includes everyone in the conversation, while Vivid HDR ensures the best video experience, even under widely varying lighting conditions.
- **Instant collaboration.** Plug-and-play technology lets you collaborate with others quickly and easily, bringing hassle-free video and audio to your huddle room.
- **Versatile compatibility.** Compatible with all leading video and audio-conferencing solutions. Certified for use with Microsoft Teams and works with Zoom, Cisco Webex and many more.

2. Overview

2.1 Jabra PanaCast overview

PanaCast features three cameras, which stream continuously, and patented real-time video stitching technology to create a full 180° view of the huddle room in Panoramic-4K.

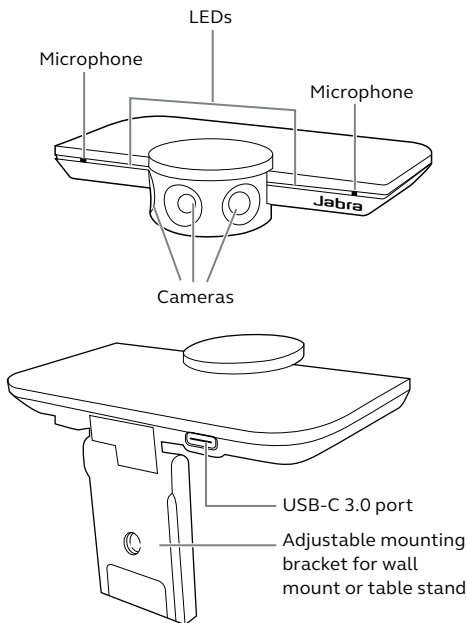

2.2 Accessories

Accessories can be purchased at jabra.com/accessories.

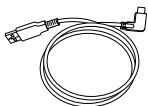

1m/3ft USB cable



1.8m/6ft USB cable
(optional)

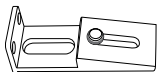

Wall mount (optional)

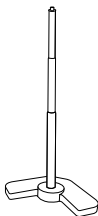
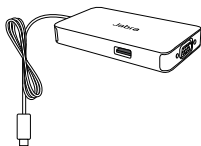

Table stand with
three cable clips
(optional)



Jabra PanaCast Hub with
built-in USB-C cable
(optional accessory)

3. Camera setup

3.1 Wall mount

The Jabra PanaCast camera can be mounted to the wall using the optional wall mount accessory. A screwdriver and two 1/4 inch screws are required (not supplied).

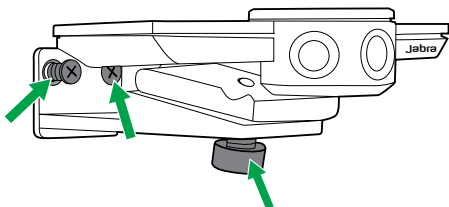

Optimally, the camera should be mounted at eye-level of the participants.

Additionally, the camera should be wall mounted 0.5m to 3.5m from participants (1.5ft to 11.5ft). Any further and the camera may pixelate the image of the participants. Any closer and the image of the participants may be negatively affected by the image stitching.

Do not mount the camera facing direct sunlight as this may affect the preset white balance and compromise the image.

3.2 Table stand

The Jabra PanaCast camera can be attached to the optional table stand using the mounting bracket on the camera.

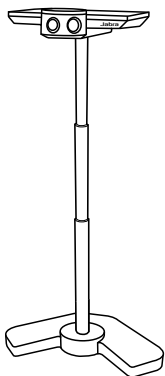

Ideally, the camera should be positioned 0.5m to 3.5m from participants (1.5ft to 11.5ft). Any further and the camera may pixelate the image of the participants. Any closer and the image of the participants may be negatively affected by the image stitching.

Do not position the camera facing direct sunlight as this may affect the preset white balance and compromise the image.

For optimal cable management, the included cable clips can be used to fasten a USB cable to the table stand.

3.3 Powering the camera

External power is not required when the camera is connected to a USB 3.0 port on your computer using the supplied USB cable.

If your computer only has USB 2.0 ports, an external powered USB hub is required to power the camera. For a list of approved USB hubs, visit jabra.com/help/panacast.

3.4 Typical room configuration

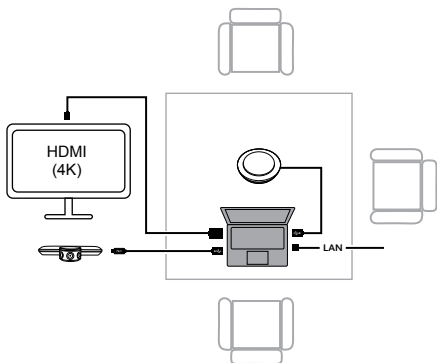
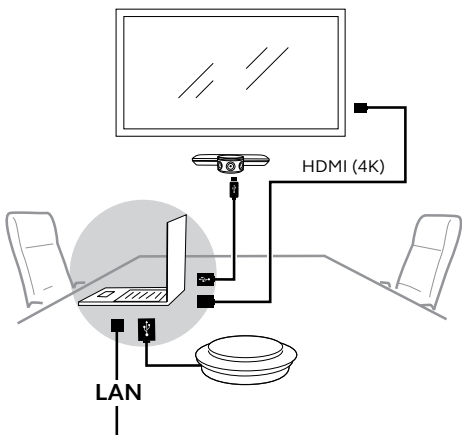

3.5 Typical room configuration (using the optional Jabra PanaCast Hub)

Ideally, the Jabra PanaCast Hub would be installed under the table and out of view.

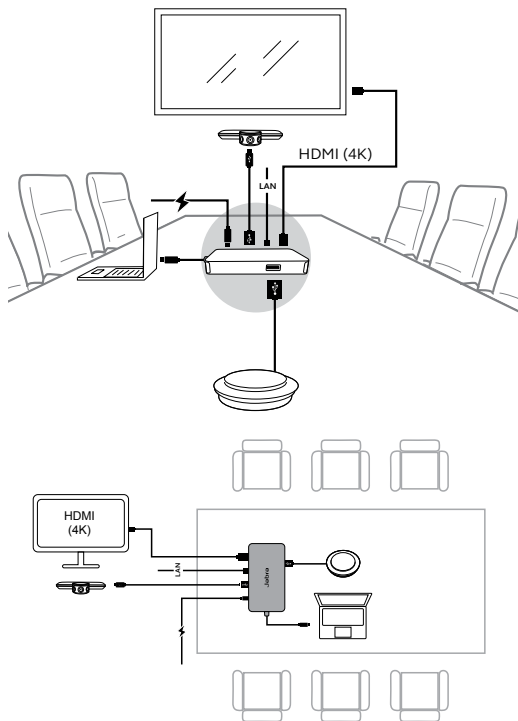

4. How to use

4.1 Supported operating systems

Jabra PanaCast supports Windows 7 or later, and macOS 10.9 or later, and does not require extra drivers.

It is recommended to download and install Jabra Direct to customize camera settings and to update the firmware. Jabra Direct can be downloaded from jabra.com/direct.

4.2 Compatible video conferencing applications

Jabra PanaCast is certified for use with Microsoft Teams and is compatible with Skype for Business, Zoom, Cisco Webex, and many more.

For more information about compatible video conferencing applications, visit jabra.com/help/panacast.

4.3 Connect your computer to the Jabra PanaCast camera

Connect your computer directly to the Jabra PanaCast camera using the supplied 1m/3ft USB cable. Optionally, a longer 1.8m/6ft USB cable can be purchased from [Jabra.com/accessories](https://www.jabra.com/accessories).

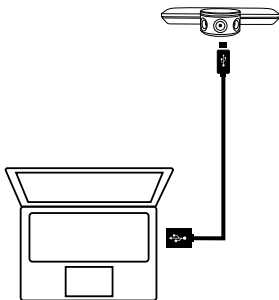

4.4 Connect your computer to the optional Jabra PanaCast Hub

Connect your computer to the Jabra PanaCast Hub using the built-in 1m/3ft USB-C cable.

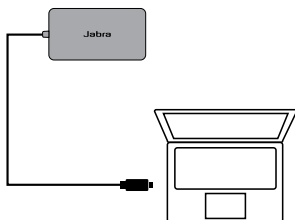

The Jabra PanaCast Hub can also be connected to a Jabra speakerphone, HDMI monitor (4K), VGA monitor (1080p), and an ethernet connection. Connection to a power outlet using the supplied power adapter is required.

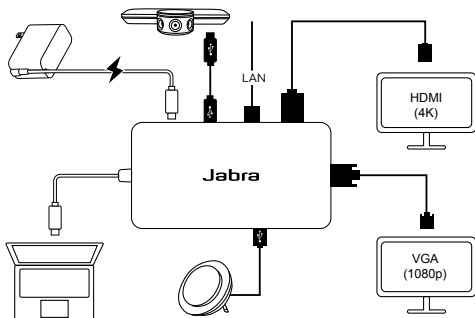

4.5 What the camera LEDs mean



Blinking blue LEDs

Camera is initializing or rebooting



Solid blue LEDs

Camera is in standby mode or not in use



Solid white LEDs

Camera is streaming

4.6 Using the camera with Microsoft Teams

When using Microsoft Teams, the Jabra PanaCast may need to be manually set as the default video device in the video settings.

1. Launch Microsoft Teams.
2. Click your account profile icon in the top right corner of Microsoft Teams.
3. Select **Settings** to open the settings menu.
4. Select the **Devices** tab in the menu list.
5. Under **Camera**, select **Jabra PanaCast** as the camera.

Select your preferred speaker or headset as the speaker and microphone under **Audio Devices**.

4.7 Using the camera with Skype for Business

When using Skype for Business, the Jabra PanaCast may need to be manually set as the default video device in the video settings.

1. Launch Skype for Business.
2. Click the **Options** icon in Skype for Business to open the Options menu.
3. Select the **Video device** tab in the menu list.
4. Select **Jabra PanaCast** in the dropdown menu to set the PanaCast as the default camera to use for video calls.
5. Deselect **Crop and center my video in meetings** to enable the wide view of the camera.

Select your preferred speaker or headset as the speaker and microphone under the **Audio device** tab.

4.8 Using the camera with other compatible video conferencing applications

Ensure the Jabra PanaCast has been set as the default video device in the video settings for your video conferencing application.

For more information about compatible video conferencing applications, visit jabra.com/help/panacast.

5. Camera features

5.1 Intelligent Zoom

Intelligent Zoom detects where participants are (up to 3.5m/11.5ft) and automatically and continuously adjusts the field of view to include everyone in the conversation.

Intelligent Zoom is on by default and can be turned on or off using Jabra Direct.

5.2 Vivid HDR

Vivid HDR automatically optimizes the video quality under a wide range of lighting conditions.

Vivid HDR is on by default and can be turned on or off using Jabra Direct.

5.3 Video adjustments

Image quality settings and pan/tilt/zoom camera adjustments can be customized using Jabra Direct.

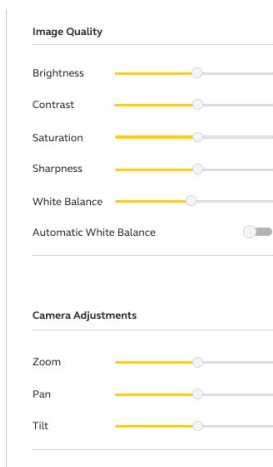

To access video adjustments:

1. Click the Jabra Direct icon located in the Windows system tray or the macOS menu bar to open the Jabra Direct window.
2. Click the settings icon next to **Jabra PanaCast** to open the Video settings.

The image quality settings and camera adjustments are temporary and will automatically reset to the default values when the connected computer is unplugged from the camera or from the Jabra PanaCast Hub.

5.4 Field of view

The viewing angle of the camera can be adjusted to 90°, 120°, 140° or 180° using Jabra Direct. By default the field of view is set to 180°.

5.5 Camera orientation

If the camera is mounted upside down, the video feed can be inverted using Jabra Direct. By default the orientation is set to Normal.

5.6 Built-in microphones

The Jabra PanaCast has two HD built-in microphones. The optimal microphone range is up to 2.5 meters or 8 feet.

The microphones are off by default, and can be turned on or off using Jabra Direct. A firmware update is required to turn the microphones on or off.

6. Software

6.1 Jabra Direct (Windows or macOS)

Jabra Direct is free software designed to support, manage and enable optimal functionality for Jabra devices.

Download the latest free version from jabra.com/direct

6.2 Update firmware

Firmware updates improve performance or add new functionality to Jabra devices.

When your computer is connected to the Jabra PanaCast, Jabra Direct will notify you when an update is available.

7. Support

7.1 FAQ and technical specifications

View the FAQ, certifications, and technical specifications at jabra.com/help/panacast.

7.2 How to care for your Jabra device

- The Jabra PanaCast is for indoor use only.
- Avoid direct sunlight and temperatures above 40°C/104°F or below 0°C/32°F.
- Do not expose the camera, hub or cables to rain or other liquids.
- Do not position the camera near the vents of a monitor or TV as this may cause the camera to overheat and malfunction.

The camera may become warm to the touch when connected to power. Due to the multiple processors, it is normal for the camera to operate at an elevated temperature. This elevated temperature is completely within safety operating requirements and has no bearing on the lifespan of the camera.