

Box-PC System BPCAL02-i3XA Industry

Without Operation System, Intel Core i3,
8 GB RAM, 128 GB SSD, DC-input 9-36V

FANLESS BOX-PC WITH INTEL CORE-I3 PROCESSOR IN A ROBUST CHASSIS

Shuttle BPCAL02-i3XA is a fully-configured fanless Box-PC with Intel Core-i3 processor of the 12th Generation (Alder Lake) in a ruggedized box design for high durability. This fixed configuration comes with a selection of pre-installed I/O extensions for a wide range of industrial applications.

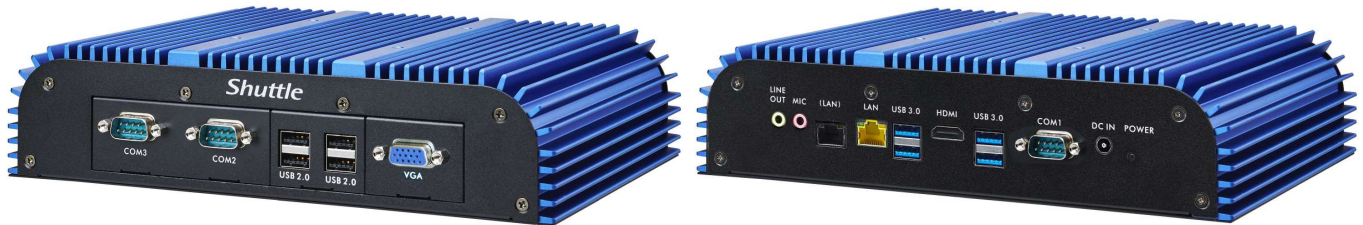

Images for illustration only

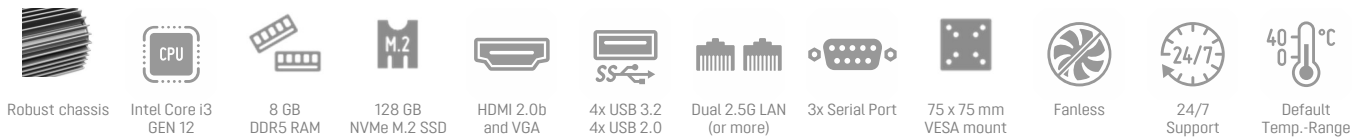

ROBUST CHASSIS

- Fanless cooling system
- Robust aluminium/steel chassis
- Dimensions (LWH): 16.9 x 24.5 x 5.7 cm (2.7 L)
- Net weight: 2.85 kg
- IP Rating: IP30
- Mounting options: VESA 75x75 mm (optional accessories: Ear mount and DIN Rail)

OPERATING TEMPERATURE RANGE

- 0 – +40 °C (Optional -20 – +60 °C)
- Operating humidity: 20 – 80% (non-condensing)

OPERATING SYSTEM SUPPORT

- An operating system is not included.
- Supports Windows 10/11 and Linux (64-bit)

PROCESSOR

- intel Core i3-1215U Gen. 12 "Alder Lake" ULV processor, 15 W TDP
- Integrated Intel UHD graphics with HDMI 2.0b and VGA port

RAM/SSD MEMORY

- 8 GB DDR5-4800 RAM
- 128 GB SSD module in M.2-2280M format, supports PCIe/NVMe

I/O CONNECTORS

- HDMI 2.0b
- D-Sub VGA
- 4x USB 3.2 Gen 2
- 4x USB 2.0
- Dual 2.5G LAN (Intel)
- 3x COM Port (1x RS232, 2x RS232/422/485)
- Mic-in and Line-out
- DC-input (2.5/5.5 mm) supports 9-36V
- Power Button

OTHER FEATURES

- Hardware TPM v2.0 Infineon SLB9670VQ2 onboard

LTE/WLAN OPTIONS

- LTE/4G kit with 2 antennas (LTE card and Nano-SIM not included)
- WLAN kit with 2 antennas Wi-Fi 6 (ax)

POWER SUPPLY

- DC-Input: 9~36V
- External 90W/19V power adapter



Barebone Models of the BPCAL02 series (without RAM/SSD and optional accessories)

Shuttle Model	Intel Gen12 ULV Processor	Cores (Threads)		Base/Turbo Clock		Smart Cache	Intel Graphics			TDP	UPC Bar Code
		P	E	P	E		Type	Max. Clock	EUs		
BPCAL02-i3	Core i3-1215U	2 (4)	4 (4)	1.2 / 4.4 GHz	0.9 / 3.3 GHz	10 MB	UHD	1.1 GHz	64	15 W	887993006666
BPCAL02-i5	Core i5-1235U	2 (4)	8 (8)	1.3 / 4.4 GHz	0.9 / 3.3 GHz	12 MB	Iris Xe	1.2 GHz	80	15 W	887993006673
BPCAL02-i7	Core i7-1255U	2 (4)	8 (8)	1.7 / 4.7 GHz	1.2 / 3.5 GHz	12 MB	Iris Xe	1.25 GHz	96	15 W	887993602165

[1] For the extended operating temperature range (-20 to +60°C) a special 150W power supply (Order No. PA1501) and industrial-grade RAM/SSD components with an operating temperature range of -40 ... +85 °C are required.

Caution: Only suitably trained persons may open the barebone and install optional components!

Complete Systems of the BPCAL02 series

Shuttle Box-PC Model	Barebone Basis	OS	Processor	M.2 SSD	RAM	Front Panel I/O	EAN Bar Code
BPCAL02-i3XA Industry	BPCAL02-i3	—	Core i3-1215U	128 GB	8 GB DDR5	2x COM, 4x USB 2.0, VGA	4046047104215
BPCAL02-i5WA Industry IoT	BPCAL02-i5	Win10 IoT	Core i5-1235U	250 GB	8 GB DDR5	2x COM, 4x USB 2.0, VGA	4046047104222

Use the online **Shuttle BTO Configurator** for a customized configuration.

Front and Back Panel

Front panel

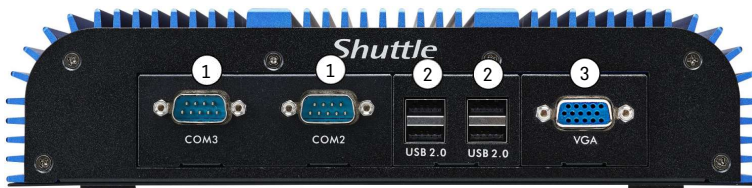

1. Dual COM ports support RS232/RS422/RS485
2. 4x USB 2.0 port
3. D-Sub VGA port

Back panel

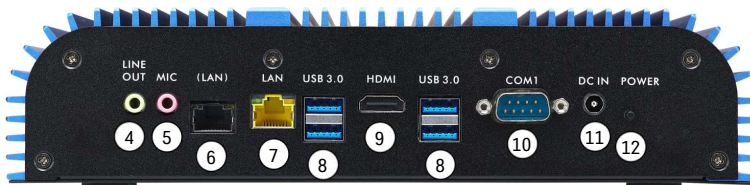

4. Audio Line Out (Headphones output)
5. Microphone input
6. 2.5 Gbps LAN Port (Intel i226V)
7. 2.5 Gbps LAN Port (Intel i226V)
8. 4x USB 3.2 Gen 1 Type A port
9. HDMI 2.0b port
10. COM port (RS232)
11. DC-in connector for power adapter
12. Power button

Dimensions

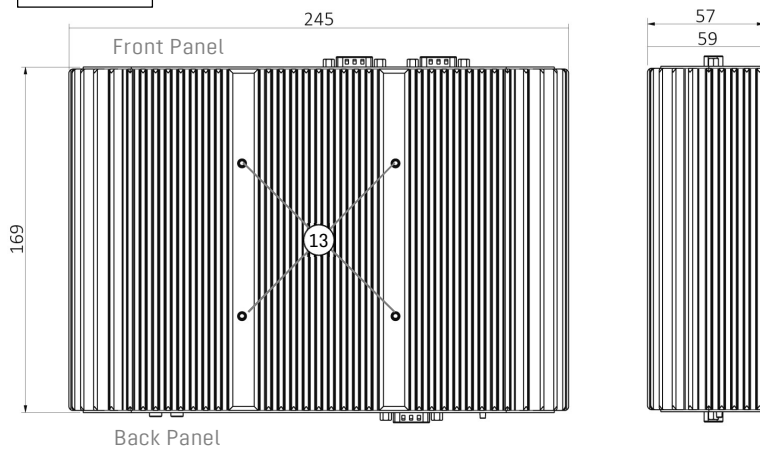





13. Screw threads for VESA mount (75x75 mm)

Dimensions:

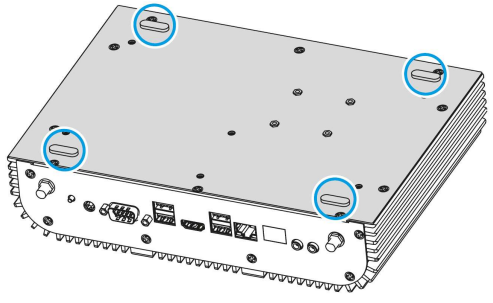
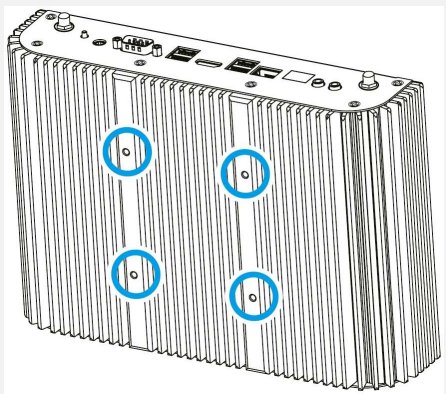
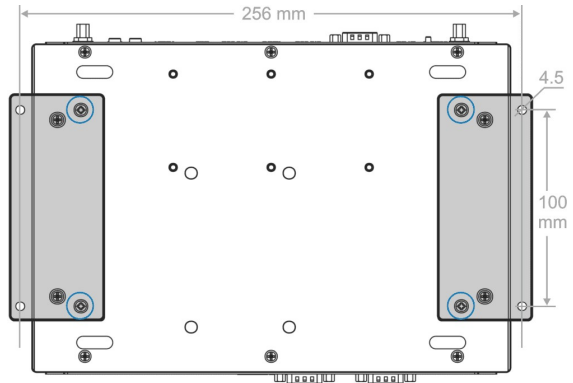
Width: 245 mm (without optional ear mount)
 Depth: 169 mm
 Height: 57 mm (59 mm including feet)

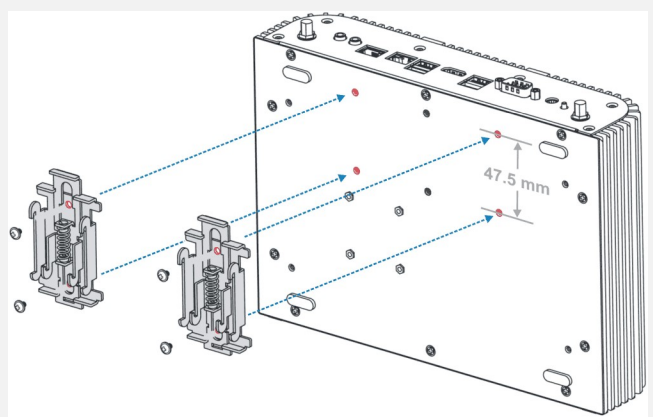
Operating Positions and Mounting

	NOTE	IMAGE
Placed horizontally	The Shuttle Box-PC series BPCAL02 can be operated in horizontal position like a desktop PC standing on its rubber feet.	
VESA-mounted	The Shuttle Box-PC series BPCAL02 features four threaded M4 holes on the upper side for a standard 75 x 75 mm VESA mount, which allows for installation on to walls or large displays. The VESA mount is not included.	
Ear-mounted	The Shuttle Box-PC series BPCAL02 features four threaded M3 holes on the bottom, which allows for it to be attached to two Ear Mount brackets (optional accessory MRS01). The Box-PC can then be affixed to a surface with four M4 screws (mounting dimension: 256 mm x 100 mm).	 
DIN-Rail-mounted	The Shuttle Box-PC series BPCAL02 features several threaded M3 holes on the bottom, which allows for installation of two DIN-Rail clips to mount this PC on a standard 35 mm DIN-Rail, e.g. inside equipment racks. The matching DIN-Rail clips are an optional accessory (2x MDR01) – please use two of them as shown in the picture.	 

SHUTTLE Box-PC Barebone BPCAL02-i3XA Industry – SPECIFICATIONS

FANLESS AND SILENT	Equipped with passive cooling, no fan noise at all Perfect to be used in noise-sensitive environments Fanless, dust-free and thus virtually maintenance-free
24/7 NONSTOP OPERATION	This device is approved for 24/7 permanent operation. Requirement: Free circulation of air amongst the PC must be guaranteed.
CHASSIS	Durable and rugged chassis made of aluminium and steel. Passive cooling system with specially designed fins to maximize heat dissipation. Dimensions: 16,9 x 24,5 x 5,7 cm (LWH) = approx. 2,7 litres Weight: 2.85 kg net (Barebone without RAM/SSD and optional expansions) IP-rating: IP30
OPERATING POSITIONS AND MOUNTING	<p>1) Desktop: The unit can be placed horizontally to stand on its feet.</p> <p>2) VESA Mount: The unit can be affixed to a 75 mm x 75 mm VESA bracket. For this purpose, four M4x6L screws are required to be screwed into the chassis from the top.</p> <p>3) Side Brackets (MRS01 = 2 brackets): The unit can be mounted using two optional 256 mm x 100 mm ear-mount brackets. For this purpose, four M3x6L screws are required to be screwed into the chassis from the bottom.</p> <p>4) DIN-Rail Clips (2x MDR01): Mounted on a standard 35 mm DIN-Rail, e.g. inside equipment racks. This requires two standard DIN rail clips, each of which is attached to the underside of the BoxPC with two M3 screws (hole spacing: 47.5 mm). Notes: VESA bracket, Ear-Mount and DIN-Rail clips are not included. Vertical mounting is permitted in any orientation.</p>
OPERATING SYSTEM	This barebone system comes without operating system. It is compatible with Windows 10/11 (64-bit) and Linux (64-bit).
PROCESSOR	<p>Model: Intel Core i3-1215U (ULV) 12th Generation Intel Core, code name "Alder Lake-U" System-on-a-chip architecture (SoC) with integrated memory and graphics controller FCBGA1744 package - directly soldered onto the mainboard Processor cores: total 6</p> <ul style="list-style-type: none"> - Performance Cores: 2 P-Cores (4 Threads) at 1.2 / 4.4 GHz basis/turbo clock - Efficient Cores: 4 E-Cores at 0.9 / 3.3 GHz basis/turbo clock <p>Smart Cache: 10 MB TDP wattage: 15 W maximum Manufacturing process: Intel 7 (10 nm) Maximum Tjunction Temperature: 100 °C</p>
INTEGRATED GRAPHICS	<p>Intel® UHD Graphics with 64 Execution Units (EU) Graphics Max Dynamic Frequency: 1.10 GHz</p> <p>This configuration comes with two graphics connectors:</p> <ol style="list-style-type: none"> 1) HDMI 2.0b supports up to 4K/60Hz (Ultra HD 3840×2160 resolution) 2) D-Sub VGA supports 1080p/60Hz (Full HD 1920x1080 resolution)
UEFI BIOS	<p>Supports resume after power failure Supports Wake on LAN (WOL) Supports Power on by RTC Alarm Supports boot from M.2 SSD cards and USB devices AMI BIOS in 64 MB EEPROM with SPI interface Supports hardware monitoring and Watchdog function Supports Unified Extensible Firmware Interface (UEFI) Supports Intel vPro Essential</p>
TPM MODULE	H/W-TPM V2.0: Hardware Trusted Platform Module V2.0 (Infineon SLB9670VQ2)
POWER ADAPTER	<p>External 90 W power adapter (fanless) Input: 100~240 V AC, 50/60 Hz, max. 1.6 A Output: 19 V DC, max. 4.74 A, max. 90 W AC mains cable: 3 pins, ca. 1.8 m length, with C5/C6 coupler (called "Mickey Mouse" or "Clover-leaf") for the power adapter and CEE-7/7 plug with earth-contact (type E+F) for the power outlet</p>
DC INPUT	<p>Extended DC input voltage range thanks to the built-in VOL01 module DC input supports 9-36 V DC DC Input connector: 5.5 / 2.5 mm (outer/inner diameter)</p>
RAM MEMORY	<p>8 GB DDR5-4800 (PC5-38400) SDRAM at 1.1 V 2x SO-DIMM slot with 262 pins supports a maximum of 32 GB per DIMM maximum total size: 64 GB</p>

M.2 SSD MODULE	128 GB SSD module in M.2-2280 form factor Supports NVMe with PCI Express interface
AUDIO	Audio Realtek® ALC888S High-Definition Audio Two analog audio connectors (3.5 mm) on the back panel: 1) 2 channel line out (headphones) 2) microphone input Digital multi-channel audio output: via HDMI and optional DisplayPort
DUAL 2.5G LAN	Dual network with RJ45 ports and Intel i226V network chips Supports 10 / 100 / 1000 / 2500 MBit/s operation Supports WAKE ON LAN (WOL) Supports network boot by Preboot eXecution Environment (PXE)
FRONT PANEL CONNECTORS	2x COM port (supports RS232/422/485) 4x USB 2.0 1x VGA D-Sub Port
BACK PANEL CONNECTORS	HDMI 2.0b 4x USB 3.2 Gen 2 Type A (max. 10 Gbps) 2x Intel 2.5G LAN (RJ45, i226V) Serial COM port (RS232) Microphone input (3.5 mm) Audio Line-out / Headphones (3.5 mm) DC-input connector for external power adapter (2.5 / 5.5 mm) supports 9-36V DC
OPTIONAL ACCESSORIES	1) Ear-mount brackets, mounting dimensions: 256 mm x 100 mm (MRS01) 2) DIN-Rail clip (special clip has holes without thread) (2x MDR01) 3) WLAN module with two external antennas (WMAX2001+CWL01)
ENVIRONMENTAL SPECIFICATIONS	Operating temperature range: 0~40 °C Relative humidity, non-condensing: 0~90 %
CONFORMITY AND CERTIFICATIONS	EMI: CE, FCC Class A, VCCI, RCM, BSMI Safety: CB, cTUVus, BSMI Other: RoHS, ErP, CEC This device is classed as a technical information equipment (ITE) in Class A, Class A is for product used in commercial and industrial areas. The CE-mark approves the conformity by the EU directives: (1) 2014/30/EU relating to electromagnetic compatibility (EMC), (2) 2014/35/EU relating to Electrical Equipment designed for use within certain voltage limits (LVD), (3) 2009/125/EC relating to eco design requirements for energy-related products (ErP)