



Liebert[®] GXT5 Lithium-Ion UPS

Installer/User Guide

230V Input, 230V Output, 1000-3000VA

The information contained in this document is subject to change without notice and may not be suitable for all applications. While every precaution has been taken to ensure the accuracy and completeness of this document, Vertiv assumes no responsibility and disclaims all liability for damages resulting from use of this information or for any errors or omissions. Refer to other local practices or building codes as applicable for the correct methods, tools, and materials to be used in performing procedures not specifically described in this document.

The products covered by this instruction manual are manufactured and/or sold by Vertiv. This document is the property of Vertiv and contains confidential and proprietary information owned by Vertiv. Any copying, use or disclosure of it without the written permission of Vertiv is strictly prohibited.

Names of companies and products are trademarks or registered trademarks of the respective companies. Any questions regarding usage of trademark names should be directed to the original manufacturer.

Technical Support Site

If you encounter any installation or operational issues with your product, check the pertinent section of this manual to see if the issue can be resolved by following outlined procedures.

Visit <https://www.vertiv.com/en-us/support/> for additional assistance.

TABLE OF CONTENTS

1 Important Safety Instructions	1
2 Vertiv™ Liebert® GXT5 Lithium-Ion Description	3
2.1 Available Models	3
2.2 Front Panel	4
2.3 Rear Panel	4
2.4 External Battery Cabinet	7
2.5 Major Internal Components and Operating Principle	7
2.6 UPS States and Operating Modes	8
2.6.1 Normal mode	8
2.6.2 Bypass mode	8
2.6.3 Battery mode	9
2.6.4 Frequency converter mode	9
2.6.5 ECO mode	9
3 Installation	11
3.1 Unpacking and Inspection	11
3.2 Pre-installation Preparation	11
3.2.1 Installation clearances	11
3.3 Installing the UPS	12
3.3.1 Tower installation	12
3.3.2 Rack installation	13
3.4 Installing External Battery Cabinets	14
3.5 Connecting AC Input Power	16
3.5.1 Connecting loads	17
3.6 Communication Connections	17
3.6.1 Connecting IntelliSlot communication	17
3.6.2 Connecting to the dry contact and REPO port	17
3.6.3 Connecting a Remote Emergency Power Off (REPO) switch	20
3.6.4 Connecting the USB cable	21
3.6.5 Connecting CLI communication cables	21
3.6.6 UPS management software	21
4 Operating the UPS	23
4.1 Silencing the Audible Alarm	23
4.2 Starting up the UPS	23
4.3 Transferring to Battery Mode	23
4.4 Transferring from Normal to Bypass Mode	24
4.5 Transferring from Bypass to Normal Mode	24
4.6 Shutting Down the UPS Completely	24
4.7 Remote Emergency Power Off (REPO)	24

- 5 Operation and Display Panel 25**
- 5.1 LED Indicators 26
- 5.2 LCD Menu and Screens 27
 - 5.2.1 Startup and flow screens 27
 - 5.2.2 Main menu 27
 - 5.2.3 Status screen 28
 - 5.2.4 Settings submenu 30
 - 5.2.5 Control screen 37
 - 5.2.6 Log screen 37
 - 5.2.7 About screen 41
- 5.3 Editing Display and Operation Settings 43
 - 5.3.1 Settings prompts 43
 - 5.3.2 Changing the password 44
 - 5.3.3 Selecting the display language 44
 - 5.3.4 Setting the date and time 45
- 6 Maintenance 47**
- 6.1 Replacing Batteries 47
- 6.2 Charging Batteries 49
- 6.3 Checking UPS Operation 49
- 6.4 Cleaning the UPS 50
- 6.5 Installing or Replacing Optional Dust Filter 50
- 6.6 Firmware Updates 51
- 7 Troubleshooting 53**
- 7.1 Symptoms that Require Troubleshooting 53
- 7.2 Audible Alarm (Buzzer) 53
 - 7.2.1 Faults 53
- 7.3 Troubleshooting UPS Issues 54
- 8 Specifications 55**
- 8.1 Battery Run Times 59
- Appendices 62**
- Appendix A: Technical Support 62

1 Important Safety Instructions

IMPORTANT! This manual contains important safety instructions that must be followed during the installation and maintenance of the UPS and batteries. Read this manual thoroughly and the safety and regulatory information, available at <https://www.vertiv.com/ComplianceRegulatoryInfo>, before attempting to install, connect to supply, or operate this UPS.

This page intentionally left blank

2 Vertiv™ Liebert® GXT5 Lithium-Ion Description

The Liebert® GXT5 Lithium-Ion is a compact, online Uninterruptible Power System (UPS) that continuously conditions and regulates its output voltage. The Liebert® GXT5 Lithium-Ion supplies microcomputers and other sensitive equipment with clean sine wave input power.

Upon generation, AC power is clean and stable. However, during transmission and distribution it is subject to voltage sags, spikes, and complete failure that may interrupt computer operations, cause data loss, and damage equipment.

The Liebert® GXT5 Lithium-Ion protects equipment from these disturbances. The Liebert® GXT5 Lithium-Ion continuously charges its batteries from the mains, enabling it to supply power to connected loads, even when the mains fail.

2.1 Available Models

The Liebert® GXT5 Lithium-Ion includes the following features. **Table 2.1** below, lists the available models and power ratings.

- Input power factor greater than 0.99.
- Optional tower or rack installation to meet varying installation requirements.
- Adapts to areas with unstable power mains supply via high frequency double conversion topology structure, with high input power factor, wide input voltage range, and output immune to grid interference.
- Programmable outlets allow for load shedding to protect key devices when load is heavy.
- Operation and display panel with model specific color LCD offers simple configuration and control of the UPS.
- ECO power supply mode and smart sleep mode help to save maximum amount of energy.

Table 2.1 UPS Models and Power Ratings

UPS Model	Nominal Power Rating at 230 V Input
GXT5LI-1000IRT2UXL	1000 VA/1000 W
GXT5LI-1500IRT2UXL	1500 VA/1500 W
GXT5LI-2000IRT2UXL	2000 VA/2000 W
GXT5LI-3000IRT2UXL	3000 VA/2700 W

Table 2.2 UPS Models and Optional External Battery Cabinet (EBC)

UPS Model	EBC Model	Maximum Number of EBCs
GXT5LI-1000IRT2UXL	VEBCLI-48VRT1U	8
GXT5LI-1500IRT2UXL		
GXT5LI-2000IRT2UXL		
GXT5LI-3000IRT2UXL		

Table 2.3 UPS Models and Internal Battery Kit

UPS Model	Internal Battery Kit Model	Quantity Required
GXT5LI-1000IRT2UXL	GXT5LI-48VBATKIT1	1
GXT5LI-1500IRT2UXL	GXT5LI-48VBATKIT2	1
GXT5LI-2000IRT2UXL		
GXT5LI-3000IRT2UXL		

2.2 Front Panel

The various Liebert® GXT5 Lithium-Ion models have the same general appearance, with the main difference being the receptacle types on the rear panel.

Figure 2.1 Front View



2.3 Rear Panel

Figure 2.2 below, Figure 2.3 on the facing page and Figure 2.4 on page 6 detail the rear panel features for each Liebert® GXT5 Lithium-Ion model.

Figure 2.2 GXT5LI-1000/1500IRT2UXL

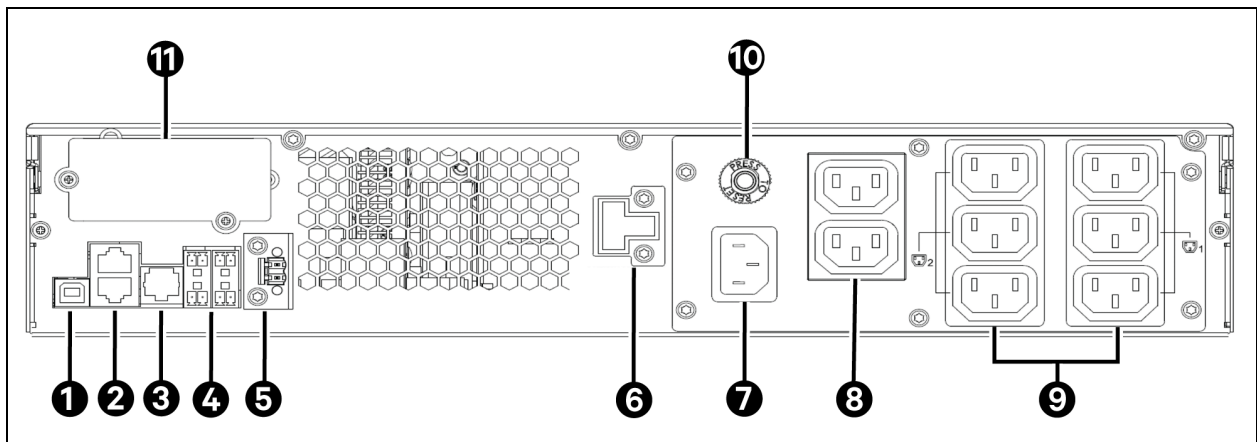

Item	Description
1	USB port
2	External Battery Cabinet (EBC) CAN ports
3	RS-232 port (used for CLI)
4	Dry contact communication terminal block
5	Remote Emergency Power Off (REPO)
6	EBC terminal
7	Input power plug (C14)
8	Non programmable output receptacles (C13)
9	Programmable output receptacles (C13)
10	Input circuit breaker (10 A)
11	Vertiv™ Liebert® IntelliSlot™ port

Figure 2.3 GXT5LI-2000IRT2UXL Rear Panel

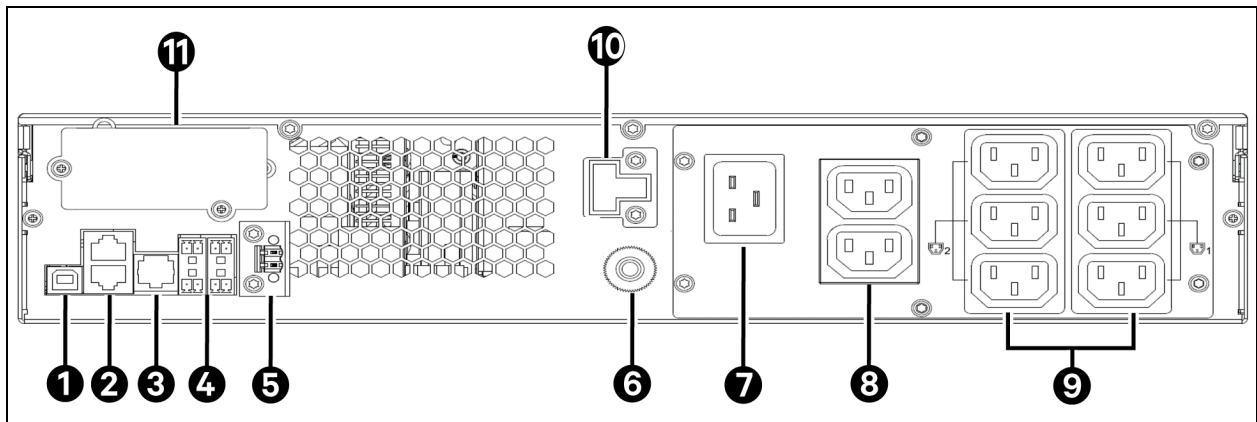

Item	Description
1	USB port
2	External Battery Cabinet (EBC) CAN ports
3	RS-232 port (used for CLI)
4	Dry contact communication terminal block
5	Remote Emergency Power Off (REPO)
6	Input circuit breaker (16 A)
7	Input power plug (C20)
8	Non programmable receptacles (C13)
9	Programmable receptacles (C13)
11	EBC terminal
12	Liebert® Intellislot™ port

Figure 2.4 GXT5LI-3000IRT2UXL Rear Panel

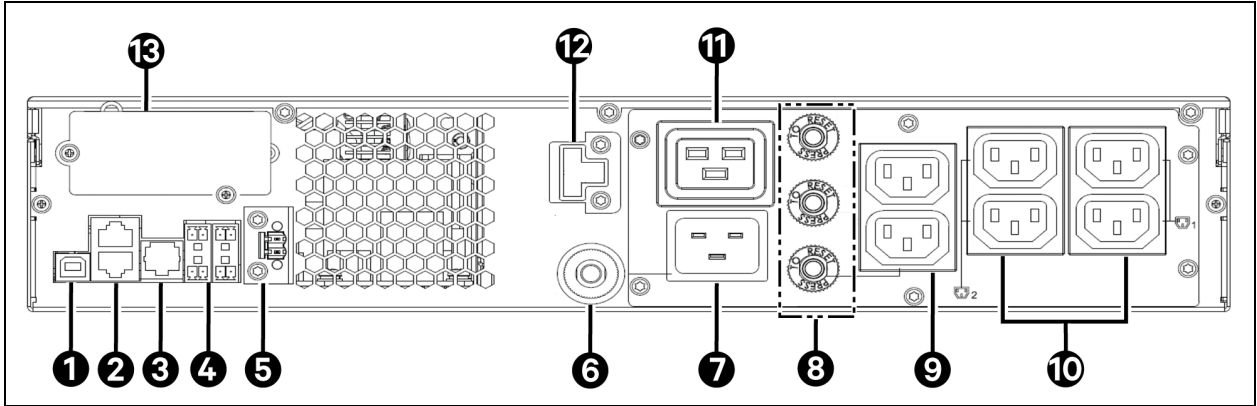

Item	Description
1	USB port
2	External Battery Cabinet (EBC) CAN ports
3	RS-232 port (used for CLI)
4	Dry contact communication terminal block
5	Remote Emergency Power Off (REPO)
6	Input circuit breaker (20 A)
7	Input power plug (C20)
8	Output circuit breakers (10 A)
9	Non programmable output receptacles (C13)
10	Programmable output receptacles (C13)
11	Non programmable output receptacle (C19)
12	EBC terminal
13	Vertiv™ Liebert® IntelliSlot™ port

2.4 External Battery Cabinet

An optional external battery cabinet (VEBCLI-48VRT1U) is available for all UPS models. The external battery cabinet includes a battery power cable and communication cable. Up to 8 battery cabinets may be connected in parallel to the UPS. By default, the battery cabinets will be automatically detected by the UPS once connected. Auto detection can be changed in the settings menu. See [Settings submenu](#) on page 30, for more information. See **Table 9.3** on page 57, for the cabinet specifications. See [Battery Run Times](#) on page 59, for approximate battery run times with additional EBCs. See [Installing External Battery Cabinets](#) on page 14, to connect the cabinets.

Figure 2.5 External Battery Cabinet

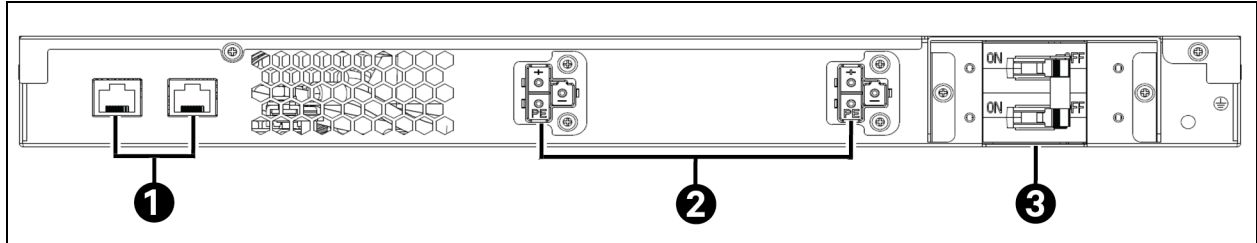

Item	Description
1	Communication ports
2	Battery connectors
3	Battery breaker

2.5 Major Internal Components and Operating Principle

Figure 2.6 below, shows the UPS operating principle. **Table 2.4** on the next page, describes the function of the major components in the UPS.

NOTE: Figure 2.6 below, is one example of basic operation.

Figure 2.6 Basic Operating Principle Diagram

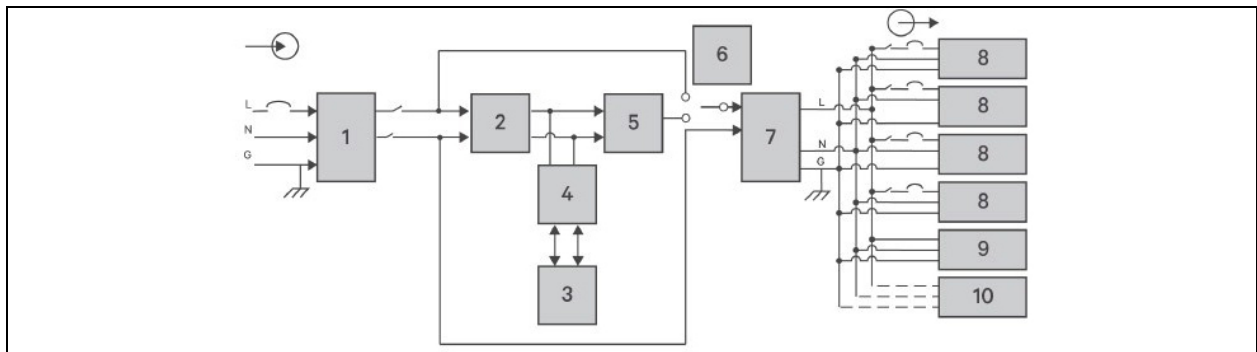

Table 2.4 Major Components

Item	Component	Operation/Function
1	Transient Voltage Surge Suppression (TVSS) and EMI/RFI Filters	Provide surge protection. Filter Electromagnetic Interference (EMI) and Radio Frequency Interference (RFI). Minimize surges or interference present in the utility power and protect devices connected on the same branch as the UPS.
2	Rectifier/Power Factor Correction (PFC) Circuit	In normal operation, converts utility AC power to regulated DC power for use by the inverter while ensuring that the wave shape of the input current used by the UPS is near ideal. Extracting this sine wave input current ensures efficient use of utility power and reduces reflected harmonic distortion making cleaner power available to devices that are not protected by the UPS.
3	Batteries	Lithium-ion batteries. NOTE: The optimum battery ambient temperature range is 59°F-86°F (15°C-30°C).
4	DC to DC Converter	Raises the DC voltage from the battery to the optimum operating voltage for the inverter. This allows the inverter to operate continuously at its optimum efficiency and voltage, thus increasing reliability.
5	Inverter	In normal operation, converts utility AC power to regulated DC power for use by the inverter while ensuring that the wave shape of the input current used by the UPS is near ideal. Extracting this sine wave input current ensures efficient use of utility power and reduces reflected harmonic distortion making cleaner power available to devices that are not protected by the UPS.
6	Dynamic Internal Bypass	In the unlikely event of UPS failure such as overload or over temperature, automatically transfers the connected load to bypass. To manually transfer the connected load from inverter to bypass, see Transferring from Normal to Bypass Mode on page 24 .
7	EMI/RFI Filters	Filter Electromagnetic Interference (EMI) and Radio Frequency Interference (RFI). Minimize interference present in the utility power and protect devices connected on the same branch as the UPS.
8	Outlet group	Programmable output receptacles.
9	Outlet group	General output receptacles.
10	Outlet group	General output receptacles on 3000 VA models only.

2.6 UPS States and Operating Modes

NOTE: LED Indicators on page 26 , for description of the run indicator and alarm indicator LEDs mentioned in this section.

2.6.1 Normal mode

When utility power is normal, the Normal mode employs the rectifier and inverter to provide voltage and frequency stabilized power to the load. The battery is charged in the normal mode. On the front panel display, the run indicator (green) is ON, the alarm indicator is OFF, and the buzzer is silent. The LCD Flow screen displays energy flow from the input power source to the battery and then to the UPS inverter.

2.6.2 Bypass mode

Bypass mode supplies power to the load from the bypass source (utility power), if an overload or fault occurs during normal operation. On the front panel display, the run indicator (green) is ON, the alarm indicator (yellow) is ON, and the buzzer beeps once each seconds. The LCD Flow screen displays energy flow from the input power source through the bypass path instead of the UPS inverter.

NOTE: If utility power fails or the utility voltage goes outside of the permissible range during bypass mode operation, the UPS shuts down and no output is supplied to the load.

2.6.3 Battery mode

Battery mode supplies battery power to the load if utility power fails or if the utility voltage goes outside of the permissible range. On the front panel display, the run indicator (green) is ON, the alarm indicator (yellow) is ON, and the buzzer beeps once each second. The LCD Flow screen displays energy flow from the battery through the UPS inverter. The battery status displays Discharge.

NOTE: The batteries are fully charged before shipment. However, transportation and storage inevitably cause some loss of capacity. To ensure adequate backup time, it is recommended to charge the batteries for at least 2 hours before first startup.

NOTE: If utility power fails and the batteries have charge then cold start the UPS in battery mode and use battery power to extend system availability for a time. At least one external battery cabinet is required for cold start.

NOTE: Powering off the UPS when it is in battery mode results in loss of output power to the connected load.

2.6.4 Frequency converter mode

All models of the Vertiv™ Liebert® GXT5 Lithium-Ion are capable of frequency conversion. Frequency Conversion Mode can be selected using the Settings menu. For more information on the Settings menu, see [Settings submenu](#) on page 30 .

Allowable frequency operating modes include:

- Auto Sensing - 50 Hz or 60 Hz – Bypass Enabled
- Auto Sensing - 50 Hz or 60 Hz – Bypass Disabled
- Frequency Converter - 50 Hz – Bypass Disabled
- Frequency Converter - 60Hz – Bypass Disabled

NOTE: Auto Sensing at 50 Hz or 60 Hz and Bypass Enabled is set default for all models of the Liebert® GXT5 Lithium-Ion.

2.6.5 ECO mode

The energy saving ECO mode reduces power consumption by powering the load via bypass if the bypass voltage is normal or by powering the load via the inverter when the bypass voltage is abnormal. Make use of ECO mode to power equipment that is not sensitive to power grid quality via bypass and reduce power consumption.

NOTE: During ECO mode, if a bypass failure or abnormal bypass voltage notification appears when the output is not overloaded, the UPS will transfer to Normal Mode. However, if a notification showing bypass failure or abnormal bypass voltage appears when the output is overloaded, the UPS will shut down the bypass and therefore the load will shut down.

This page intentionally left blank

3 Installation

NOTE: Do not start the UPS until the installation is finished.



WARNING! Risk of electric shock. Can cause equipment damage, injury and death. Before starting with installation, verify that all external overcurrent protection devices are open (Off), and that they are locked out and tagged appropriately to prevent activation during the installation, verify with a voltmeter that power is Off. And wear appropriate, OSHA approved personal protective equipment (PPE) per NFPA 70E. Failure to comply can cause serious injury or death. Before proceeding with installation, read all instructions and follow all local codes.

3.1 Unpacking and Inspection

Unpack the UPS and conduct the following checks:

- Inspect the UPS for shipping damage. damage. If any shipping damage is found, report it to the carrier and the local Vertiv.
- Check the accessories included against the packing list. Contact local Vertiv representative immediately in the case of any discrepancy.



CAUTION: The UPS is heavy (see [Specifications](#) on page 55 , for the weight). Take proper precautions when lifting or moving the unit.

3.2 Pre-installation Preparation

- Install the UPS indoors in a controlled environment, where it cannot be accidentally turned off. The installation environment should meet the specifications listed in [Specifications](#) on page 55 .
- Place the UPS in an area of unrestricted air flow around the unit, away from water, flammable liquids, gases, corrosives, and conductive contaminants. Avoid direct sunlight.

NOTE: Operating the UPS in temperatures above 77°F (25°C) reduces battery life.

3.2.1 Installation clearances

Maintain at least 4 inches (100 mm) of clearance in the front and rear of the UPS. Do not obstruct the air inlets on the front panel and rear panel of the UPS. Blocking the air inlets reduces ventilation and heat dissipation, shortens the service life of the unit.

3.3 Installing the UPS

The UPS may be installed as a tower or in a rack, depending on available space and use considerations. Determine the type of installation and follow the appropriate instructions. See [Tower installation](#) below or [Rack installation](#) on the facing page .

NOTE: When installing the UPS or making input and output connections, comply with all relevant safety codes and standards.

3.3.1 Tower installation

To install the UPS as a tower:

1. Take the support bases out of the accessories box.

Figure 3.1 Support Bases

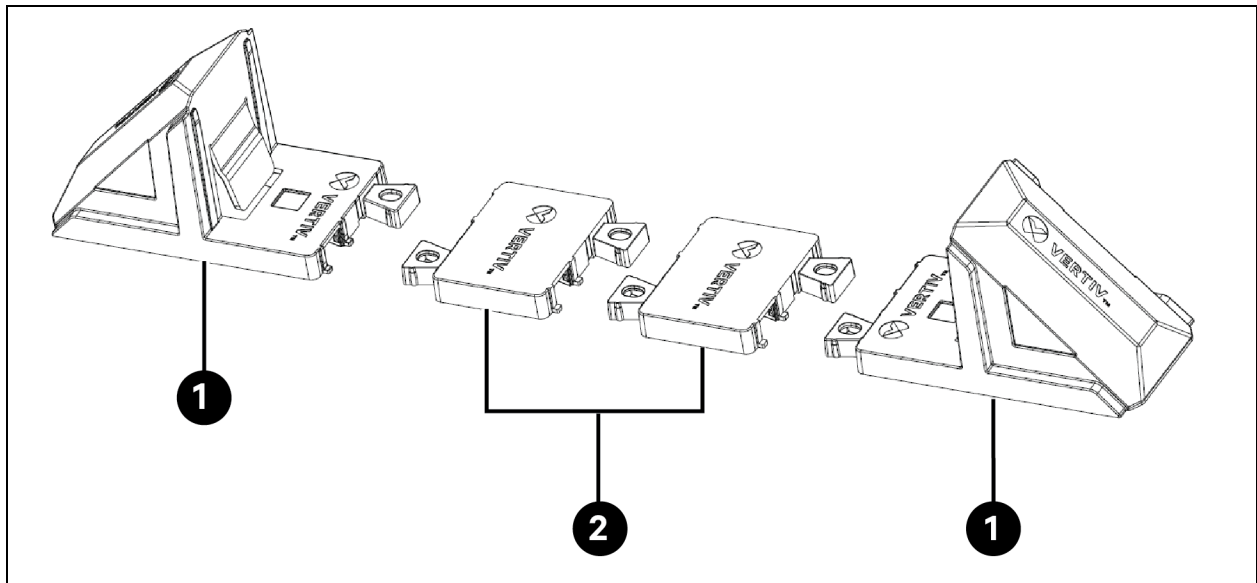

Item	Description
1	Support bases
2	Spacers with connectors NOTE: Two spacers are shown here. If installing without external battery cabinets no spacer is needed. One spacer is needed for each additional battery cabinet.

2. If optional, Vertiv™ Liebert® external battery cabinets needs to be connected, take out the spacers shipped with the battery cabinet.
3. Connect the spacers and the support bases as shown in **Figure 3.1** above. Each Vertiv™ Liebert® GXT5 Lithium-Ion requires 2 support bases, one in the front and one in the rear.
4. Place the Liebert® GXT5 Lithium-Ion and any battery cabinets on the 2 support bases and spacers (if applicable).

3.3.2 Rack installation

When installed in a rack enclosure, the Vertiv™ Liebert® GXT5 Lithium-Ion UPS and External Battery Cabinets (EBC) must be supported by a shelf or rack mount rails.

Procedure:

1. Attach rail kit inner guides to the UPS.
2. Attach the handles to the UPS.
3. Install the rail kit outer guides in the rack.

NOTE: Align shelf of rack kit with rack U number for proper alignment.

4. Install the UPS in the rack.
5. Secure the handles to the rack.

Figure 3.2 UPS Rack Installation

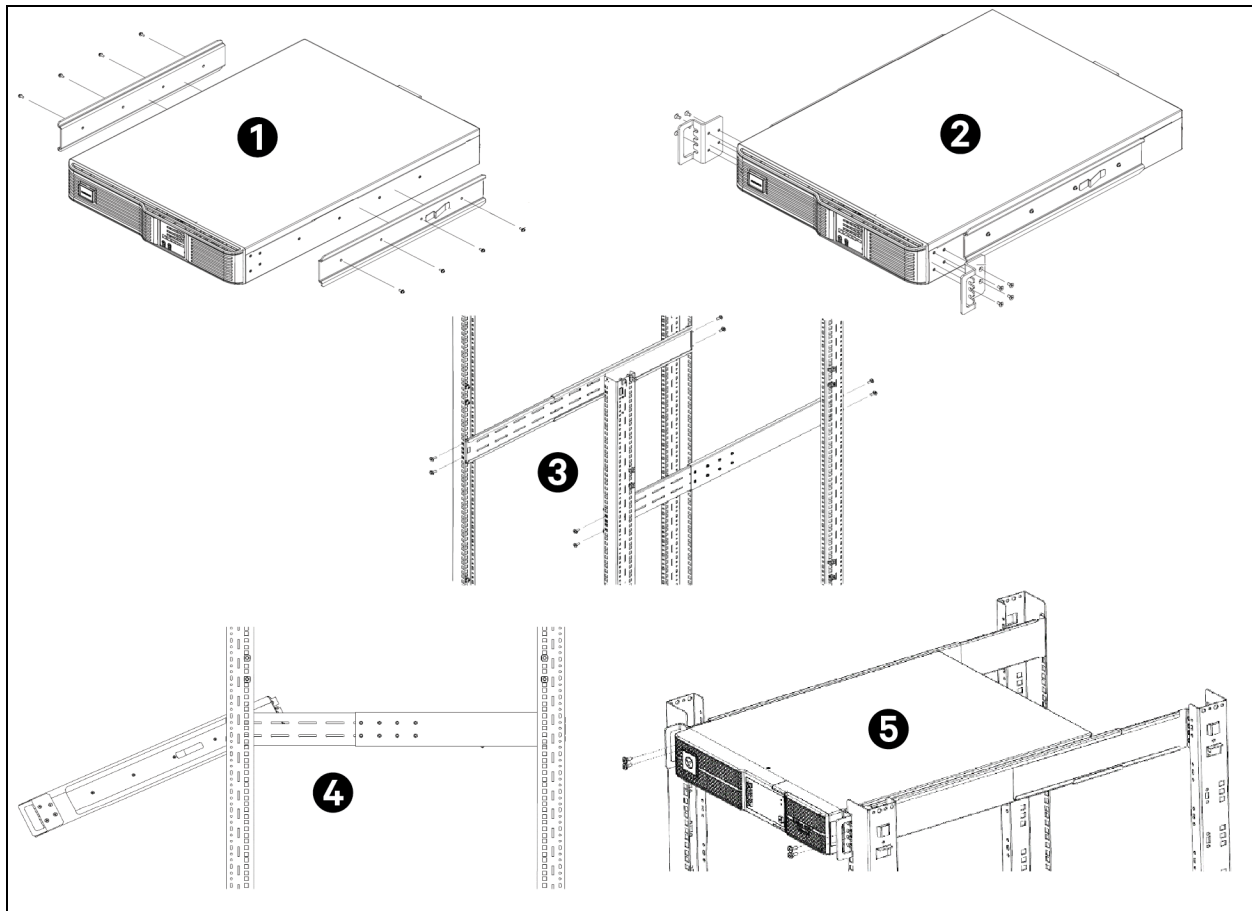

3.4 Installing External Battery Cabinets

Optional, External Battery Cabinets (EBC) may be connected in parallel to the UPS to provide additional battery run time. For approximate battery run times with additional EBCs, see [Battery Run Times](#) on page 59. External battery cabinets are placed on one side of the UPS in a tower configuration or stacked beneath the UPS in a rack configuration. Up to 8 EBCs may be connected to the UPS. By default, battery cabinets will be automatically detected by the UPS once connected. Auto detection can be changed in the settings menu. For more information, see [Settings submenu](#) on page 30.



WARNING! Risk of electric shock. Can cause injury or death. Disconnect all local and remote electric power supplies before working with the UPS. Ensure that the unit is shut down and power has been disconnected before performing any maintenance.

To install the EBCs:

1. Inspect the EBC for freight damage. Report damage to the carrier and the local dealer or Vertiv representative.
2. For tower installation:
 - An additional set of support base extensions shipped with each EBC.
 - See the steps in [Tower installation](#) on page 12, to connect the support extenders and install the bases.

- or -
3. For rack installation:
 - a. Attach rail kit inner guides onto the EBC.
 - b. Attach the handles to the EBC.
 - c. Install the rail kit outer guides in the rack.

NOTE: Align shelf of rack kit with rack U number for proper alignment.

- d. Install the EBC in the rack.
- e. Secure the handles to the rack.

Figure 3.3 EBC Rack Installation

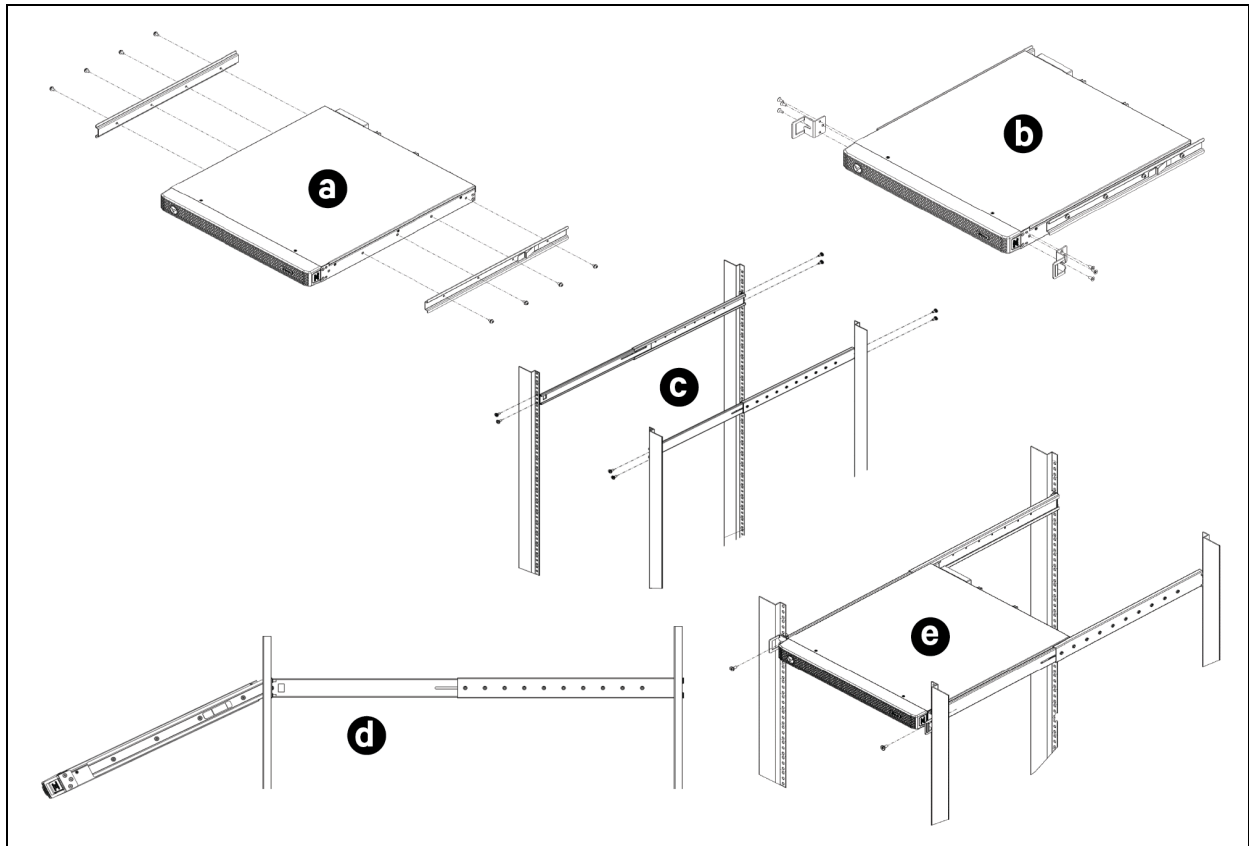

4. Verify that the EBC breaker is in the “Off” position.
5. Connect the cables (included in the package) as per the following instructions, see **Figure 3.4** on the next page for reference:
 - a. Connect one end of the EBC cable to the UPS EBC terminal (1a in **Figure 3.4** on the next page) and one end to the battery cabinet EBC terminal (1b). Connect one end of the CAN communication cable (attached to the EBC cable) to the UPS CAN port (1c) and the other end to the battery cabinet CAN port (1d).
 - b. If connecting more than one battery cabinet, connect one end of an additional EBC cable to the open EBC terminal on the first battery cabinet (2a). Connect the other end to the EBC terminal of the second battery cabinet (2b). Connect one end of the CAN communication cable to the CAN port of the first battery cabinet (2c) and the other end to the CAN port of the second battery cabinet (2d).
 - c. Repeat step b for each battery cabinet. If desired for redundancy, an additional CAN communication cable can be connected from the open CAN port of the last EBC (3a) to the open CAN port of the UPS (3b). This cable is not provided, a standard Cat-5 network cable can be used for this connection.

Figure 3.4 EBCs Connected to the UPS

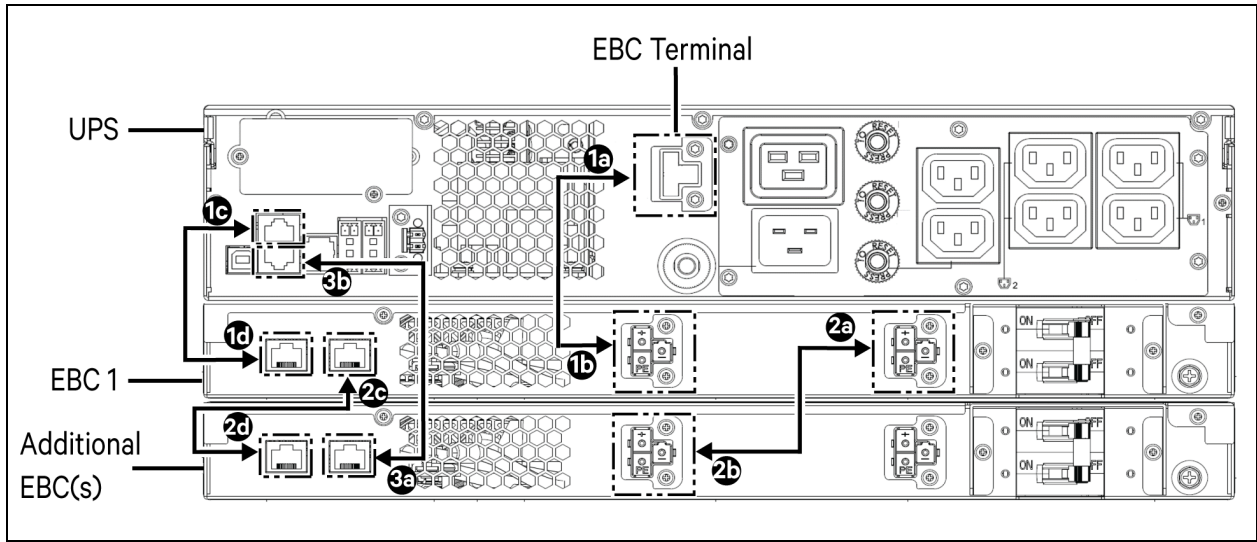

6. Turn the EBC breaker in each EBC to the “On” position. The additional backup run time is enabled.

NOTE: When removing an EBC, turn off the circuit breaker on the rear of the cabinet before disconnecting the cable.

NOTE: If shipping or storing the UPS for an extended time, disconnect the EBCs to minimize standby current drain on the batteries and help maintain design life.

3.5 Connecting AC Input Power

Ensure that all the loads are turned off. Prepare an input power supply that is properly protected by a circuit breaker in accordance with national and local electrical codes. The wall receptacle must be grounded. We recommend installing an upstream circuit breaker of the same series as the input circuit breaker of the Vertiv™ Liebert® GXT5 Lithium-Ion.

Table 3.1 below, lists the specifications of the input circuit breaker on the rear panel by UPS model.

Table 3.1 Input Circuit Breaker Specifications

Model	Rated Circuit Breaker
GXT5LI-1000IRT2UXL	10 A
GXT5LI-1500IRT2UXL	10 A
GXT5LI-2000IRT2UXL	16 A
GXT5LI-3000IRT2UXL	20 A

To connect AC input power, plug the input plug of the UPS into the input power connection.

NOTE: If the input plug will serve as the disconnecting device, the wall socket/outlet must be near the UPS and must be easily accessible, per the National Electric Code/NFPA 70 requirements.

3.5.1 Connecting loads

1. The 1000 VA to 2000 VA models have eight outlets:
 - Two are not programmable (always on).
 - Six (two groups of three) are controlled with programmed responses in the settings menu accessed through the display or an SNMP network.
2. The 3000 VA models have seven outlets:
 - Three are not programmable (always on).
 - Four (two groups of two) are controlled with programmed responses in the settings menu accessed through the display or an SNMP network.

NOTE: When connecting load, verify that the equipment is plugged into the appropriate outlets, if any of the outlets will be controlled. Do not overload any output receptacle. Output cable length should not exceed 32.8 ft (10 m).

To connect equipment, plug equipment into the appropriate output receptacles on the rear of the UPS, see the appropriate figure for the model in [Rear Panel](#) on page 4 .

3.6 Communication Connections

The UPS offers several communication interfaces and ports.

NOTE: We recommend that signal cable lengths be less than 10 ft (3 m), and are kept away from power cabling.

3.6.1 Connecting IntelliSlot communication

The Vertiv™ Liebert® IntelliSlot™ RDU101 communications card provides advanced monitoring and control of the Vertiv™ Liebert® GXT5 Lithium-Ion. Visit www.vertiv.com/rdu101 for additional information.

See the appropriate figure for the model in [Rear Panel](#) on page 4 , for the location of the card port.

To install an Liebert® IntelliSlot™ card:

1. Remove the screws from the slot cover plate and remove the plate.
2. Insert the card into the slot, and secure with the screws that were removed in step 1. Refer to the documentation with the card or at the link above for cable connection and operation.

Vertiv™ Power Insight can be used with a network communication card to help improve efficiency, protect valuable critical equipment and increases visibility of the UPS. See [UPS management software](#) on page 21 for more information.

3.6.2 Connecting to the dry contact and REPO port

The UPS includes a dry contact port. See the appropriate figure for the model in [Rear Panel](#) on page 4 , for the location of the port. **Figure 3.5** on the next page, shows the ports and **Table 3.2** on page 19, describes each port.

The I/O dry contact port capacity is 125 VAC, 0.5 A; 30 VDC, 1 A.

Figure 3.5 Dry Contact and REPO Port with Pin Layout

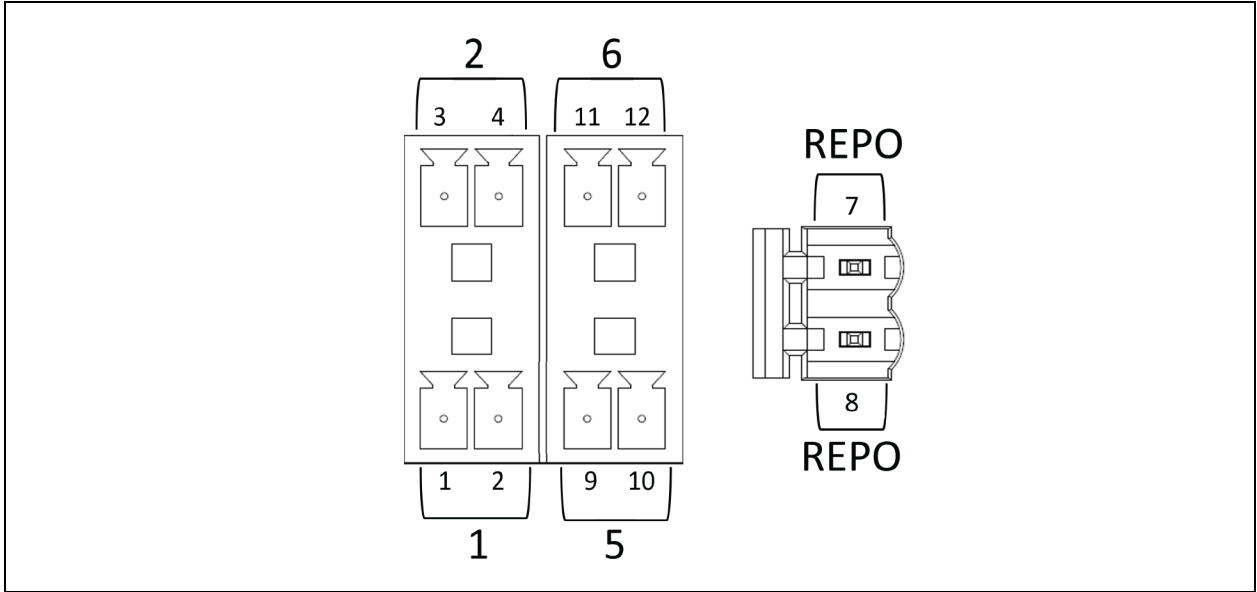

NOTE: Pins 7 and 8 are shorted before delivery.

NOTE: The REPO disables the UPS rectifier, inverter, and bypass, but it cannot disconnect the UPS mains input. To completely disconnect the UPS, disconnect the upstream input circuit breaker when activating the EPO. For details on REPO connection and operation, see [Connecting a Remote Emergency Power Off \(REPO\) switch](#) on page 20 .

Table 3.2 Dry contact Connection and Pin-out Descriptions

Port Number	Port Name	Pin Number	Pin Name	Description
1	Input 1	1	Remote Comms Shutdown 1	User configurable dry contact input that can be set to trigger the events below. The user can also select the dry contact as either NO or NC. (See System Parameter Options on page 34) When NO, Pins 1 and 2 are shorted to trigger the event. When NC, Pins 1 and 2 are opened to trigger the event. Options are mentioned below: <ul style="list-style-type: none"> • Disable (default) • Battery mode shutdown - If the UPS is running on batteries and this input is triggered, the UPS shuts down • Any mode shutdown - If this input is triggered, the UPS shuts down regardless of current operating mode
		2	Signal Ground	Signal Ground
2	Input 2	3	Remote Comms Shutdown 2	User configurable dry contact input that can be set to trigger the events below. The user can also select the dry contact as either NO or NC. (See System Parameter Options on page 34) When NO, Pins 3 and 4 are shorted to trigger the event. When NC, Pins 3 and 4 are opened to trigger the event. Options are mentioned below: <ul style="list-style-type: none"> • Disable (default) • Battery mode shutdown - If the UPS is running on batteries and this input is triggered, the UPS shuts down • Any mode shutdown - If this input is triggered, the UPS shuts down regardless of current operating mode
		4	Signal Ground	Signal Ground
5	Output 5	9,10	Remote Fault Alert 5	User configurable dry contact output that can be set to alert the user to the faults below. The user can also select the dry contact as either NO or NC. (See System Parameter Options on page 34) When NO, Pins 9 and 10 are shorted when the fault occurs. When NC, Pins 9 and 10 are opened when the fault occurs. Options are mentioned below: <ul style="list-style-type: none"> • Low battery (default) • On battery • On bypass • UPS fault
6	Output 6	11,12	Remote Fault Alert 6	User configurable dry contact output that can be set to alert the user to the faults below. The user can also select the dry contact as either NO or NC. (See System Parameter Options on page 34) When NO, Pins 11 and 12 are shorted when the fault occurs. When NC, Pins 11 and 12 are opened when the fault occurs. Options are mentioned below: <ul style="list-style-type: none"> • Low battery • On battery • On bypass • UPS fault (default)
REPO	REPO Input	7	+5V	REPO power supply, 5-Vdc 100-mA
		8	REPO Coil -NC	NC, activated when Pin 7 and Pin 8 is open NOTE: For details on REPO connection and operation, see Connecting a Remote Emergency Power Off (REPO) switch on the next page .

3.6.3 Connecting a Remote Emergency Power Off (REPO) switch

The UPS includes a REPO connection in the dry contact port. See the appropriate figure for your model in [Rear Panel](#) on page 4 , for the location of the port.

UPS ships with a REPO jumper installed, allowing the UPS to operate as a normally closed switch system (fail safe). Opening the circuit disables the UPS. To connect a REPO switch that opens the circuit to shut down the rectifier and inverter and power off the UPS, use a cable from the remote switch to plug into the REPO port on the UPS.

In normal conditions, the REPO switch cannot cut off the UPS input power. When the REPO switch trips, the UPS generates an alarm and immediately cuts off battery charging and output power. When the emergency condition is resolved, the UPS will not return to normal operation until the reset is done using REPO switch and then manually power on the UPS.

To make the cable for the REPO connection:

Figure 3.6 below, shows the cable required to make the connection. We recommend using 18 AWG to 22 AWG (0.82 mm² to 0.33 mm²) copper core cable.

1. Remove the insulation from the end of two wire.
2. Insert the stripped end into the plug terminals 1 and 2 respectively, then screw down the terminals. Make sure that the cables are secure in the plug to prevent failure because of loose contact.

To connect a UPS to the REPO switch.

! **CAUTION: To maintain safety (SELV) barriers and electromagnetic compatibility, signal cables should be shielded and run separately from power cables.**

Connect one end of the cable to the remote switch, see **Figure 3.6** below.

3. Remove the factory installed jumper from Pins 7 and 8 of the dry contact port on the UPS
4. Connect the plug to Pins 7 and 8.

Figure 3.6 Cable/Plug for Connecting REPO switch to UPS REPO port

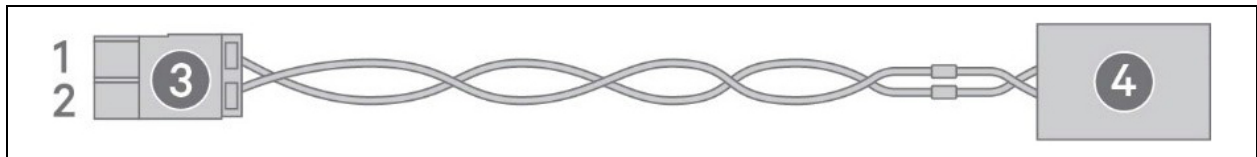

Item	Description
1	Terminal 1
2	Terminal 2
4	Plug (connects to REPO port on UPS)
4	REPO switch

3.6.4 Connecting the USB cable

Direct monitoring of the Vertiv™ Liebert® GXT5 Lithium-Ion and unattended controlled shutdown of the computer in case of a power failure can be done using the Vertiv Power Assist software via the USB port. See [UPS management software](#) below for more information.

3.6.5 Connecting CLI communication cables

The UPS supports the Vertiv command line interface for operation with Vertiv™ Avocent® ACS and other third party monitoring protocols. The RJ-45 port (labeled “R232”) is used for CLI connection. See the appropriate figure for the model in [Rear Panel](#) on page 4, for the location of the port. The pin out, described in below table is consistent with the ACS pin out.

Pin	Signal
1	NC
2	NC
3	TXD (out)
4	GND
5	NC
6	RXD (in)
7	NC
8	NC

3.6.6 UPS management software

Vertiv offers two UPS management software packages:

- Vertiv™ Power Insight software provides UPS management and graceful unattended system shutdown in the event of an extended power outage. Power Insight requires a network card. Visit www.vertiv.com/powerinsight for a free download of the software and additional information.
- Vertiv™ Power Assist is an easy to use management and shutdown software package. Power Assist connects locally to the UPS via a USB port. Visit www.vertiv.com/powerassist for a free download of the software and additional information.

This page intentionally left blank

4 Operating the UPS



WARNING! Risk of electric shock. Can cause injury or death. Hazardous mains and/or battery voltage exists behind the protective cover. No user accessible parts are located behind the protective covers that require a tool for removal. Only qualified service personnel are authorized to remove such covers. If maintenance for rack is needed, notice that the neutral line is live.

4.1 Silencing the Audible Alarm

The audible alarm may sound during UPS operation. To silence the alarm, press and hold the ESC button for 2 seconds. The button is located on the front panel display, see [Operation and Display Panel](#) on page 25 .

4.2 Starting up the UPS

IMPORTANT! Do not start the UPS until after the installation is finished, the system is commissioned by an authorized engineer, and the external input circuit breakers are closed.



CAUTION: Starting the UPS applies mains/utility power to the output terminals. Make sure that the load power is safe and ready to accept power. If the load is not ready, isolate the load with the output terminal.

The UPS starts in Normal Mode.

To start the UPS:

1. Ensure that the REPO connector on the rear of the unit has a jumper between the pins or that it is properly wired to an Emergency Power Off circuit (normally closed).
2. Connect the UPS input plug to an input power receptacle. Make sure the breaker supplying power to the UPS is closed, and if necessary press the input circuit breaker reset buttons at the rear of the UPS.
3. Power on the UPS by pressing and holding the power button on the operation and display panel until the confirmation dialog appears. Use the Up/ Down arrows to select YES, then press Enter.
4. If this is the first time startup of the UPS, the Startup Guidance wizard opens to set the basic parameters of the UPS. Follow the prompts.

For detailed description of UPS display functions and settings, see [Operation and Display Panel](#) on page 25 .

4.3 Transferring to Battery Mode

The UPS operates in Normal mode unless the mains/utility power fails or it is performing a battery self test, then it automatically transfers to Battery mode for the backup time available or the mains/utility power is restored. Once input power is restored, the UPS returns to Normal mode.

NOTE: Battery backup run times are listed in [Specifications](#) on page 55 .

4.4 Transferring from Normal to Bypass Mode

Press and hold the power button for 2 seconds.

If the UPS is operating normally, without faults, the option to *Turn to bypass*, *Turn off output*, or *Turn off UPS* displays:

1. Use the arrow buttons to select *Turn to bypass*, and press *Enter*.
2. Use the arrow buttons to select *No* or *Yes*, then press *Enter* to confirm.

If the bypass power is outside normal operating range, do not transfer to Bypass mode.

4.5 Transferring from Bypass to Normal Mode

Press and hold the power button for 2 seconds.

If the UPS is operating normally, without faults, the option to *Turn on UPS*, *Turn off output*, or *Turn off UPS* displays:

1. Use the arrow buttons to select *Turn on UPS*, then press *Enter*.
2. Use the arrow buttons to select *No* or *Yes*, then press *Enter* to confirm.

NOTE: The UPS automatically switches back from bypass to normal mode after an overheated or overloaded fault is cleared and normal power is restored.

4.6 Shutting Down the UPS Completely



WARNING! Risk of electric shock. Can cause injury or death. Disconnect all local and remote electric power supplies before working with the UPS. Ensure that the unit is shut down and power has been disconnected before beginning any maintenance.

Transfer to Bypass mode, see [Transferring from Normal to Bypass Mode](#) above. Then, if power to the load is not needed, open the main input circuit breaker or disconnect the input power cable from the input power.

4.7 Remote Emergency Power Off (REPO)

REPO turns off the UPS in case of any emergency conditions. In case of emergency, the REPO switch turns off the rectifier and inverter and stops powering the load immediately. The battery stops charging and discharging.

To manually power off in an emergency, disconnect the terminal connecting the REPO port on the rear of the UPS.

If mains/utility power is connected to the UPS input, the UPS control circuit remains active even though output power is disabled. To remove all mains/utility power, disconnect the external main input circuit breaker.

5 Operation and Display Panel

NOTE: The UPS has a gravity sensor function that automatically rotates the LCD display depending on tower or rack installation. See [Display orientation: Selects the orientation of the display for use in rack or tower configuration. Options are:](#) on page 33 .

IMPORTANT! Do not rotate the display. UPS has a gravity sensor function.



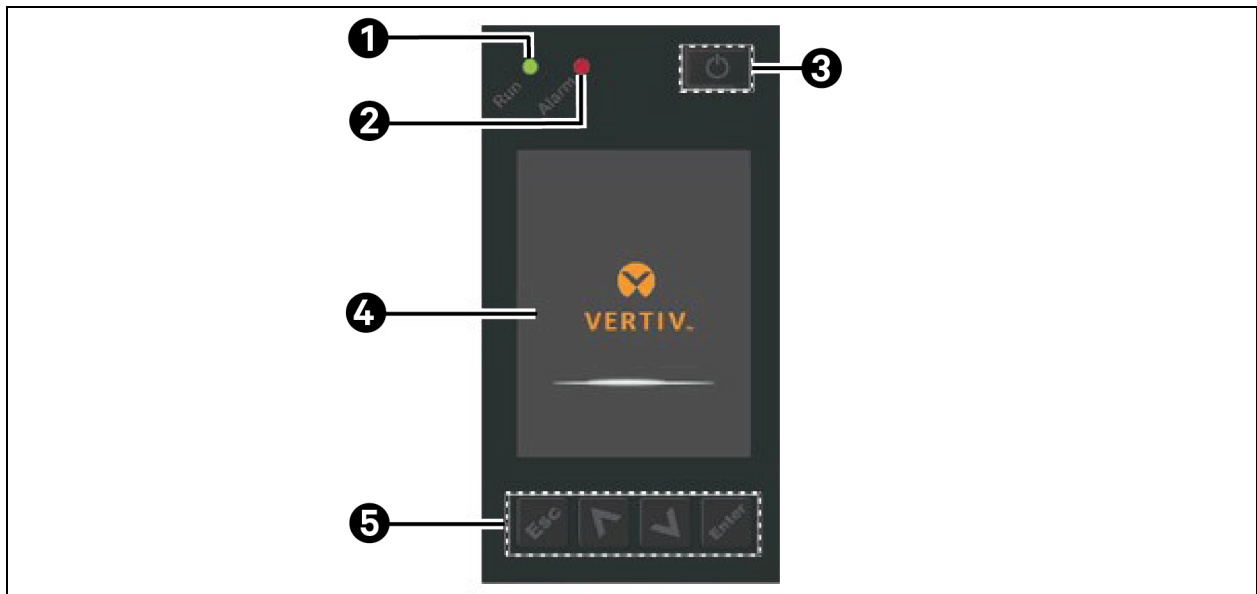

The operation/display panel includes LED indicators, function keys, and an LCD interface to configure and control UPS operation.

Figure 5.1 UPS Front Panel Display



Item	Description
1	Run indicator LED, see LED Indicators on the next page
2	Alarm indicator LED, see LED Indicators on the next page
3	Power button, see Table 5.1 on the next page
4	LCD panel
5	Menu keys, see Table 5.1 on the next page

Table 5.1 Display panel Button Functions and Descriptions

Button	Function	Description
	Enter	Confirm or enter selection
	Up/Left	Move to previous page, increase value, move left
	Down/Right	Move to next page, decrease value, move right
	Escape	Go back
	Power	Power on the UPS, power off the UPS, transfer to Bypass Mode

NOTE: While the UPS is operating, the LCD will dim and display a screen saver if there is no active alarm or user interaction for two minutes, see **Figure 5.2** below. After 4 minutes of inactivity, the display will blank to conserve power. If an alarm or fault occurs or if any button is pressed, the UPS flow screen displays.

Figure 5.2 LCD Screen Saver



5.1 LED Indicators

The LEDs on the front panel display indicate operation and alarm statuses of the UPS.

NOTE: When an alarm is indicated, an alarm message is logged on **Table 6.1** on page 38, describes the alarm messages. When a fault is indicated, front panel display list the fault, which are described in **Table 8.2** on page 54.

Table 5.2 LED Functions

Indicator	LED Color	LED State	Indicates
Run indicator	Green	On	UPS output on
		Blinking	Inverter is starting
	None	Off	UPS has no output
Alarm indicator	Yellow	On	Alarm occurs
	Red	On	Fault occurs
	None	Off	No alarm, no fault

5.2 LCD Menu and Screens

The menu driven LCD user interface allow to browse the UPS status, view operating parameters, customize settings, control operation, and view alarm/event history. Use the function keys to navigate through the menu, and view statuses or select settings in the screens.

5.2.1 Startup and flow screens

At startup, the UPS executes a system test and displays the Vertiv logo screen for about 10 seconds, shown in **Figure 5.1** on page 25. After the test completes, an overview screen shows status information, the active (green) power path, and the non working power path (gray).

NOTE: **Figure 5.3** below is an example of flow screen and does not reflect the actual values that is present on the unit.

Figure 5.3 UPS Flow Screen

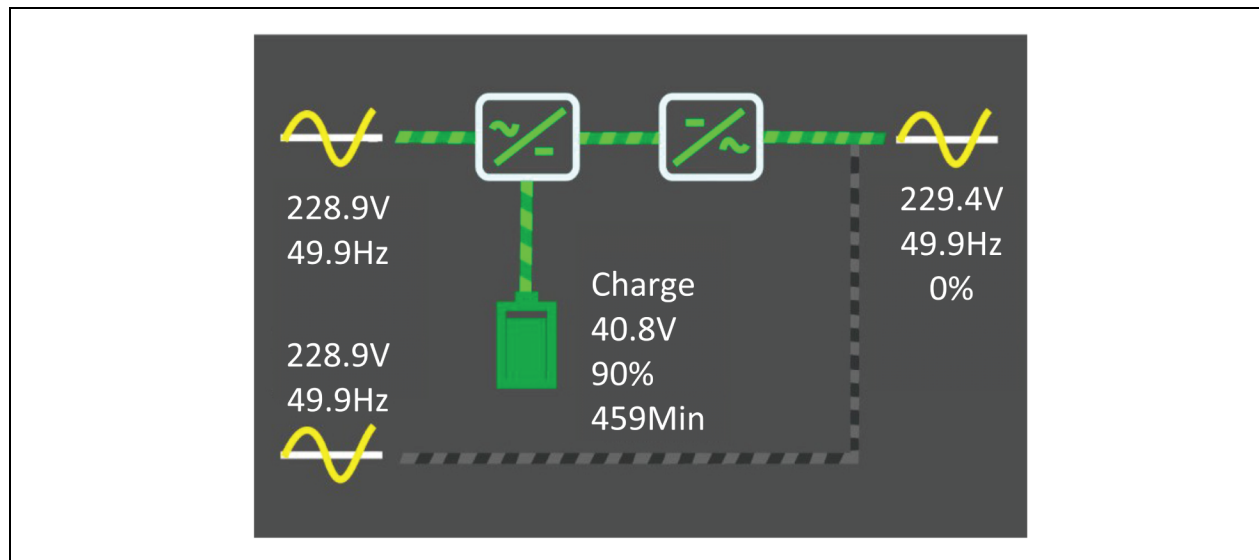

5.2.2 Main menu

To access the main menu, press *Enter* while at the flow screen. **Table 5.3** on the next page, describes the menu options, and **Figure 5.4** on the next page, describes the display.

Use the arrow buttons to select the submenu options, and press *Enter* to open the submenu. Press *ESC* to return to the flow screen.

Table 5.3 Menu Options

Submenu	Description
Status	Voltage, current, frequency, and parameters for UPS components, see Status screen below .
Settings	Display and system parameter settings, see Settings submenu on page 30 .
Control	UPS controls, see Control screen on page 37 .
Log	Current alarms and event history, see Log screen on page 37 .
About	Product and network information, see About screen on page 41 .
Maintenance	Service only, service password protected page for use only by Vertiv service representatives.

Figure 5.4 Main Menu

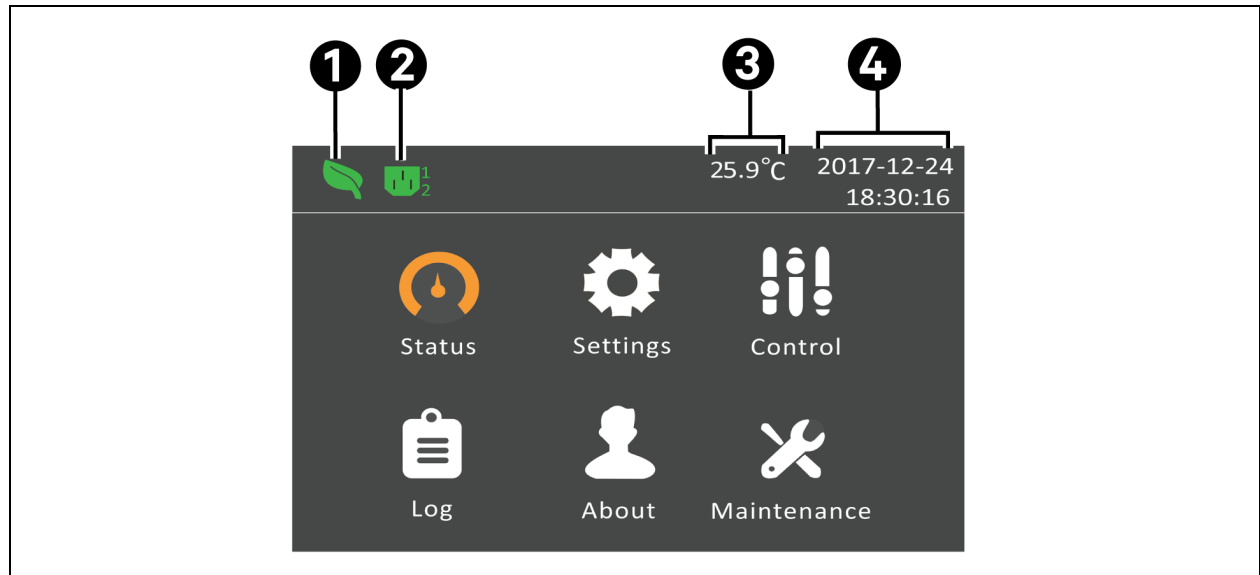

Item	Description
1	ECO mode indicator
2	Programmable outlet indicator
3	Ambient temperature
4	Date and time

5.2.3 Status screen

The status screen displays voltages, currents, frequencies, and parameters on individual tabs for Input, Bypass, Battery, Battery Management System (BMS), Output, and Load.

To view the UPS status information:

1. At the main menu, select the Status icon, and press *Enter*.

- Use the arrow buttons to move the cursor left/right and select a tab, then press *Enter* to display the status information for the selected tab.

Figure 5.5 Status Screen Tabs

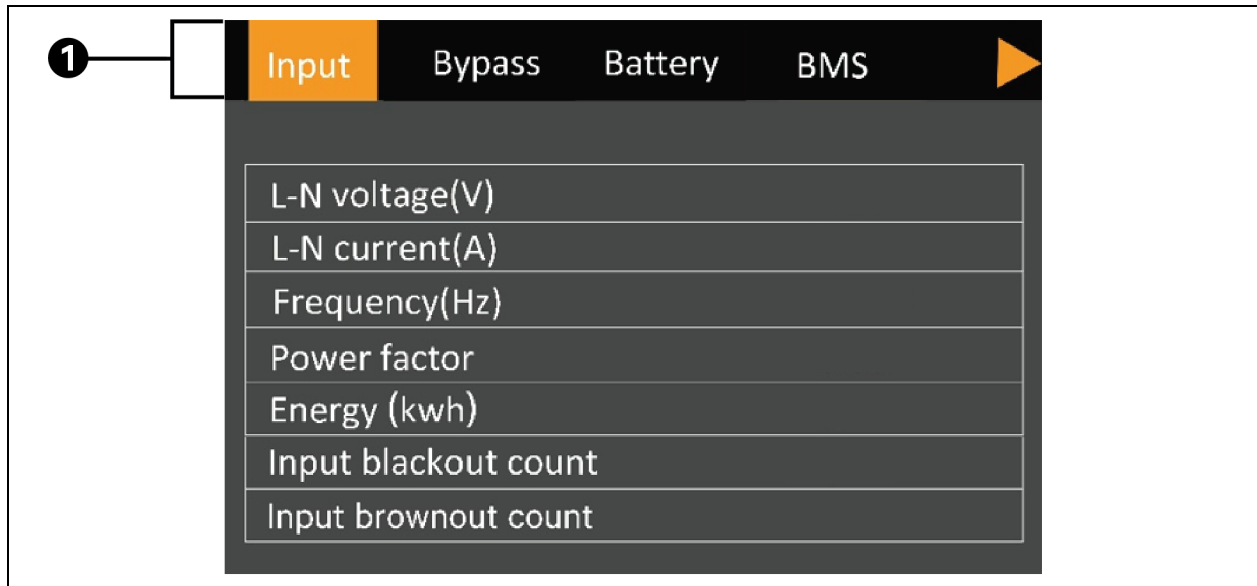

Item	Description
1	Screen tabs with Input tab selected

Input Status Options

- L-N voltage (V):** Line neutral voltage of input power.
- L-N current (A):** Line neutral current of input power.
- Frequency (Hz):** Frequency of input of input power.
- Power Factor:** Power factor of the input power.
- Energy (kWh):** Input power.
- Input blackout count:** The number of times that the input voltage was lost or dropped below 60 VAC (black out). Resets to 0 when UPS is powered down.
- Input brownout count:** The number of times that the input voltage was too low to support the load and the UPS was forced to switch to battery power (brown out). Resets to 0 when the UPS is powered down.

Bypass Status Options

- L-N voltage (V):** Line neutral voltage of bypass power.
- Frequency (Hz):** Frequency of bypass power.

Battery Status Options

- Battery status:** Current battery state: no battery, test, charging, discharging, idle, or full.
- Battery voltage (V):** Voltage of battery power.
- Battery current (A):** Current of battery power.
- Backup time (Min):** Amount of back up time remaining for battery.
- Remaining capacity (%):** Percent of capacity remaining for battery.

- **External battery cabinets:** Number of connected external battery cabinets.
- **Battery average temp (°C):** Average temperature of the battery.
- **Battery highest temp (°C):** Highest temperature battery has reached.
- **Battery lowest temp (°C):** Lowest temperature battery has reached.
- **Max cell volt (mV):** Maximum voltage the battery cell has reached.
- **Min cell volt (mV):** Minimum voltage the battery cell has reached.

Battery Management System (BMS)

- **Lithium Battery# Status:** The status of the internal battery.
- **Lithium Battery# SOC (%):** The state of charge of the internal battery.
- **Lithium Battery# SOH (%):** The state of health of the internal battery.

NOTE: Additional status, SOC(%), and SOH(%) lines will populate for each external battery cabinet, if connected.

Output Status Options

- **L-N voltage (V):** Line neutral voltage of output power.
- **L-N Current (A):** Line neutral current of output power.
- **Frequency (Hz):** Frequency of output power.
- **Energy (kWh):** Output power.

Load Status Options

- **Sout (kVA):** Apparent output power.
- **Pout (kW):** Active output power.
- **Power Factor:** Power factor of output power.
- **Load percent (%):** Percentage of connected output power rated to maximum output power.

5.2.4 Settings submenu

The settings screen consists of tabs that list UPS settings for configuration and adjusting parameters with tabs for:

- Output
- Battery
- Monitor
- System
- Outlet 1-2

NOTE: Do not change parameter settings or reset to factory defaults when powering off the UPS.

To modify UPS settings:

1. At the main menu, select the Settings icon, and press *Enter*.

NOTE: To adjust the settings, enter a password. See [Editing Display and Operation Settings on page 43](#) , for details on entering the password and editing the setting parameters.

2. Use the arrow buttons to move the cursor left/right and select a tab, then press *Enter* to display the parameter list for the selected tab.
3. Use the arrow buttons to scroll through the parameter list, and press *Enter* to select a parameter.

4. Use the arrow buttons to select the parameter value, press *Enter* to save the selection or press *Esc* to discard the change.

Output Parameter Options

Voltage selection: Nominal voltage setting. Set the nominal system voltage to match the input voltage of the UPS.

- 200 V
- 208 V
- 220 V
- 230 V
- 240 V
- Autodetect (default)

NOTE: Autodetect is set as the default. When the UPS starts for the first time, the input voltage is automatically detected and confirmed during startup guidance. After that, the confirmed value appears in the settings menu.

Startup on bypass: Allows the UPS to start up in bypass mode.

- Enable — Start the UPS in bypass mode
- Disable — Start the UPS in normal mode (default)

Frequency selection: Selects the frequency of the output. Options are:

- Auto, Bypass enabled — Automatically detects frequency of utility/mains power and sets the nominal frequency to match and bypass mode is enabled (default).
- Auto, Bypass disabled — Automatically detects frequency of utility/mains power and sets the nominal frequency to match and bypass mode is disabled.
- Frequency converter 50 Hz — Bypass mode is disabled and the UPS provides 50 Hz output from any qualified utility/mains power.
- Frequency converter 60 Hz — Bypass mode is disabled and the UPS provides 60 Hz output from any qualified utility/mains power.

Bypass voltage upper limit: Sets the percentage that the input voltage may be above the selected output voltage setting and remain in Bypass mode.

- +10% (default)
- +15%
- +20%

Bypass voltage lower limit: Sets the percentage that the input voltage may be below the selected output voltage setting and remain in Bypass mode.

- -10%
- -15% (default)
- -20%

Run mode: Selects Normal or ECO operation for the UPS. Options are:

- Normal (default) — Connected load is always powered through the UPS inverter. ECO mode is disabled.
- ECO mode — ECO mode is enabled. The UPS inverter is bypassed, and the connected load is powered by utility/mains power within the selected ECO voltage and frequency tolerances.

ECO voltage range: Sets the percentage that the input voltage may be above or below the selected output voltage setting and remain in ECO mode. This option is only shown when Run mode is set to ECO.

- ± 5%
- ± 10% (default)
- ± 15%

ECO frequency range: Sets the amount that the input frequency (Hz) may be above or below the selected frequency setting and remain in ECO mode. This option is only shown when Run mode is set to ECO.

- ± 1Hz
- ± 2Hz
- ± 3Hz (default)

ECO requalification time: To ensure the stability of the utility/mains power, this is the length of time that the UPS requires the input voltage and frequency tolerances to be maintained before switching to ECO mode. This option is only shown when Run mode is set to ECO.

- 1 min. (default)
- 5 min.
- 15 min.
- 30 min.

Battery Parameter Options

External battery: Sets the number of attached External Battery Cabinets (EBC) or allows the UPS to detect the number of EBCs automatically with Autodetect. Autodetect can only be used with Vertiv EBCs.

- 0 - 8
- Autodetect (default)

Low battery time: Sounds an alarm when the selected amount of time remaining for the UPS to operate in Battery mode.

- 2 - 30 min. (default of 2 min.)

Battery periodic test: The UPS can periodically self test the battery.

- Enable (default)
- Disable

Battery periodic test interval: Sets the length of time between periodic test. This option is only available when Battery periodic test is set to enable.

- 8, 12, 16, 20, or 26 weeks (default is 8 weeks)

Battery periodic test weekday: Sets the day of the week that the battery periodic test is performed. This option is only available when Battery periodic test is set to enable.

- Sunday - Saturday (Wednesday is default)

Battery periodic test time: Sets the time that the battery periodic test is performed. This option is only available when Battery periodic test is set to enable.

- 00:00 - 23:59 (default is 00:00)

Dischg protect time: Sets the maximum discharge time for the UPS. The default setting is the maximum allowing the battery to fully discharge. Setting the value lower limits the amount of time the UPS will provide battery protection after which it will shut down. If the discharge time remaining on the battery is lower than the setting value, it will have no effect.

- 1 - 4320 min. (default of 4320 min.)

Max chg curr: Sets the maximum charge current for the battery. A higher charge current will charge the battery more quickly but can shorten battery life. A lower value will lengthens the battery charge time and can increase battery life. The load is always prioritized and the charge current will be decreased internally if necessary to support the load.

- For GXT5LI-1000IRT2UXL: 0.6 - 3.0 A without external battery/ 8.0 A with external battery (default is 3.0 A)
- For GXT5LI-1500/2000/3000IRT2UXL: 0.6 - 4.5 A without external battery/ 8 A with external battery (default is 4.5 A)

BMS Turn off mode: Sets how the internal battery shuts down.

- Long Life Mode (default) — The internal battery will shut down after the UPS shuts down.
- Standby Mode — The internal battery will remain on until the battery detects low voltage protection.

Monitor Settings Options

Language: Selects the language of the display, see [Selecting the display language](#) on page 44 . Options are:

- English (default)
- French
- Portuguese
- Spanish
- Chinese
- German
- Japanese
- Russian
- Italian
- Czech

Date: Selects the current date for the UPS display, YYYY-MM-DD. See [Setting the date and time](#) on page 45 .

Time: Select the current time for the UPS display, HH:MM:SS. See [Setting the date and time](#) on page 45 .

Display orientation: Selects the orientation of the display for use in rack or tower configuration. Options are:

- Auto-rotate (default) — Automatically rotates based on the detected orientation of the UPS.
- Horizontal — Screen rotated for rack use.
- Vertical — Screen rotated for tower use.

Audible alarm: If enabled, the UPS will beep when an alarm is generated. If disabled, it will be silent. See [Audible Alarm \(Buzzer\)](#) on page 53 .

- Enable (default)
- Disable

Temperature unit

- Fahrenheit (°F)
- Celsius (°C) (default)

Change settings password: Opens the dialog to change the password used to access and update the UPS parameter settings, see [Changing the password](#) on page 44 .

System Parameter Options

Auto restart: Allows the automatic restart of the UPS when input power is restored after a complete shutdown of the UPS system.

- Enable (default) — The UPS will restart automatically when the input power is restored after a complete shut down.
- Disable — The UPS will not restart automatically.

Auto restart delay: Length of time to elapse before an automatic restart after input power is restored.

- 0 - 999 seconds (default 0 seconds)

Guaranteed shutdown: Forces a continued shutdown of the UPS once the Low Battery threshold is reached, even if input power is restored during this time. This can be used to make sure that connected equipment shuts down completely. When using the low battery relay output to gracefully shut down connected equipment, it is possible that the input power is restored after the Low battery output is triggered. In this situation, the connected equipment could power down smoothly but never lose input power, causing it not to start back up as intended. Enabling this option prevents this situation from occurring by ensuring a shutdown of the output.

- Enable
- Disable (default)

Start with no battery: Allows the UPS to start when the battery has reached the end of discharge (EOD). This can be used to turn on the UPS and power the attached load without battery protection when utility power has been restored after the battery was fully depleted. It works in conjunction with the Auto restart setting above.

- Enable (with Auto restart enable) — The UPS will power the load with no user intervention when mains power returns after the battery has been fully depleted.
- Enable (with Auto restart disabled) — The UPS will start up and allow the user to turn on the output when power returns after the battery has been fully depleted.
- Disable (default) — The UPS cannot start with a fully depleted battery.

Remote control: Allows the UPS to be controlled remotely via the CLI or RDU101 card.

- Enable
- Disable (default)

Any mode shutdown auto restart enable: Automatically restart the UPS after an “Any mode shutdown” signal is received. When the UPS is shut down via dry contact inputs 1 or 2, it will restart automatically if this option is enabled.

- Enable
- Disable (default)

Output contact NO/NC: Selects the states of the dry contact outputs 5 and 6.

- Normally open (default)
- Normally closed

Input contact NO/NC: Selects the states of the dry contact inputs 1 and 2.

- Normally open (default)
- Normally closed

Dry contact 5 (Output): Selects the output of dry contact 5.

- Low battery (default) — The contacts switch when the UPS reaches the amount of time left on battery configurable from “Low battery time”.
- On bypass — The contacts switch when the UPS is running in bypass mode.
- On battery — The contacts switch when the UPS is running on battery.
- UPS fault — The contacts switch when a UPS fault has occurred.

Dry contact 6 (Output): Selects the output of dry contact 6.

- Low battery — The contacts switch when the UPS reaches the amount of time left on battery configurable from “Low battery time”.
- On bypass — The contacts switch when the UPS is running in bypass mode.
- On battery — The contacts switch when the UPS is running on battery.
- UPS fault (default) — The contacts switch when a UPS fault has occurred.

Dry contact 1 (Input): Selects the action taken by the UPS when the input of dry contact 1 is triggered.

- Disable (default)
- Battery mode shutdown — If the UPS is running on batteries and this input is triggered, the UPS shuts down.
- Any mode shutdown — If this input is triggered, the UPS shuts down regardless of current operating mode.

Dry contact 2 (Input): Selects the action taken by the UPS when the input of dry contact 2 is triggered.

- Disable (default)
- Battery mode shutdown — If the UPS is running on batteries and this input is triggered, the UPS shuts down
- Any mode shutdown — If this input is triggered, the UPS shuts down regardless of current operating mode

Sleep mode: Allows the UPS to turn off the output on a weekly schedule. For instance, turn on every Monday at 1:00 and off every Friday at 23:00.

- Enable
- Disable (default)

Power on day of week: Sets the day of week to turn on the UPS. This option is only shown when Sleep mode is enabled.

- Sunday-Saturday (default Monday)

Power on time: Sets the time of day to power on the UPS on the selected day. This option is only shown when Sleep mode is enabled.

- 00:00 - 23:59 (default 00:00)

Power off day of week: Sets the day of week to turn off the UPS. This option is only shown when Sleep mode is enabled. Sunday-Saturday (default Saturday)

Power off time: Sets the time of day to power off the UPS on the selected day. This option is only shown when Sleep mode is enabled.

- 00:00 - 23:59 (default 00:00)

IT system compatibility: When this option is enabled, the “Input phase reversed” and “Input ground lost” alarms are disabled.

- Enable
- Disable (default)

Outlet Parameter Options

Apply the same settings as outlet 1: Available on Outlet2, this will apply the settings for Outlet1 on any other programmable outlet.

Turn on/off outlet: Turns on or turns off the outlet based on the current state. Provides a confirmation window with Yes/No options to confirm turning on the outlet.

Reboot outlet: Cycles power to the outlet. This option is only available when the outlet is on.

Turn on delay: Length of time before outlet turns on after UPS startup.

- 0 to 30 min. (default is 0 min.)

Turn off when UPS overload on battery: Sets whether or not to turn off the outlet if the UPS is overloaded while on battery power. This can be used to disable lower priority equipment in the event of an overload while in battery mode.

- Yes
- No (default)

Outlet settings based on discharging time

Threshold of turning off the outlet: Length of time that the outlet is powered after the batteries begin to discharge. Select the checkbox to enable or disable (default) the option.

- 0 to 30 min. (default is 5 min.)

Turn on when power returns for: Length of time after the mains input power returns before turning on the outlet. Select the checkbox to enable (default) or disable the option.

- 0 to 30 min. (default is 0 min.)

Outlet settings based on backup time

Threshold of turning off the outlet: When the selected amount of time remains on battery mode, the outlet is turned off. Select the checkbox to enable or disable (default) the option.

- 0 to 30 min. (default is 5 min.)

Turn on when power returns for: Length of time after the mains input power returns before turning on the outlet. Select the checkbox to enable or disable (default) the option.

- 0 to 30 min. (default is 0 min.)

Outlet settings based on capacity

Threshold of turning off the outlet: When the selected percentage of capacity remains in battery mode, the outlet turns off. Select the checkbox to enable or disable (default) the option.

- 20 to 80% (default is 20%)

Turn on when power returns: Length of time after the mains input power returns before turning on the outlet. Select the checkbox to enable or disable (default) the option.

- 0 to 30 min. (default is 0 min.)

5.2.5 Control screen

The Control screen offers UPS control options.

To adjust the UPS controls:

1. At the main menu, select the Control icon, and press *Enter*.
2. Use the arrow buttons to move the cursor to the option, then press *Enter* to select the control.

Figure 6.1 Control Screen

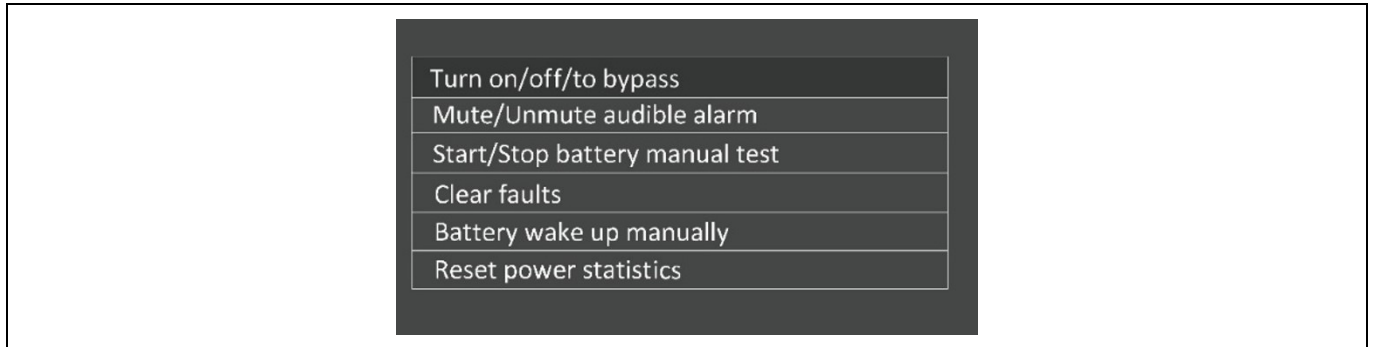

Control Options

- **Turn on/off/to bypass:** Opens the dialog to change operating modes, see [Operating the UPS](#) on page 23 .
- **Mute/Unmute audible alarm:** Silences or unmute the audible alarm, see [Silencing the Audible Alarm](#) on page 23 .
- **Start/Stop battery manual test:** Starts the battery self test manually. If the manual self test is already running, stops the self test.
- **Clear faults:** Clears displayed faults after the issue causing the fault is resolved, see **Table 8.2** on page 54, for a description of the faults.
- **Battery wake up manually:** Forces the battery to wake up if the battery does not wake up automatically.
- **Reset power statistics:** Resets the values tracked to calculate the Efficiency graph, see [About screen](#) on page 41

5.2.6 Log screen

The Log Screen offers tabs that list the current alarms and the alarm/event history. **Table 6.1** on the next page, describes the alarm messages present in the logs.

To view the logs:

1. At the main menu, select the Log icon, and press *Enter*.
2. Use the arrow buttons to move the cursor left/right and select a tab, then press *Enter* to display the log for the selected tab.
3. Use the arrow buttons to scroll up/down through the log.

Figure 6.2 Current and History Log Tabs

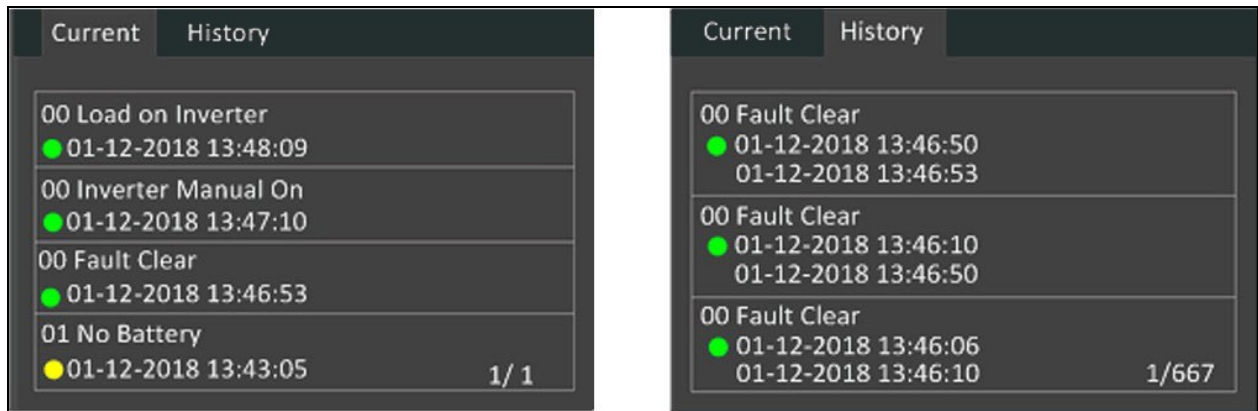

Table 6.1 Alarm Messages

Message	Description
Aux. powerfault	UPS internal auxiliary power voltage fault. Contact Vertiv Technical Support.
Battery address error	The address numbers of battery cabinet is no longer in the range of 1-16.
Battery aged	When the SOH of the battery is less than 50%, the battery aging will be reported.
Battery cabinet connect abnormal	More than 8 external battery cabinets are connected to the UPS. Disconnect excess battery cabinets.
Battery cabinet parallel fault	Battery Cabinet Parallel fail of the online lithium battery cabinet.
Battery cabinet fault	Battery Cabinet Abnormal of the online lithium battery cabinet, contact customer service.
Battery cable fault	Battery Cabinet Communication is disrupted, check the cable.
Battery checking	Check if the battery is present.
Battery comm fault	Some battery cabinets' communication is disrupted, check the communication cable.
Battery connected No. abnormal	The online battery cabinet number is different from the set external battery cabinet number. Check the battery connection or reset the external battery cabinet number.
Battery current abnormal	Battery current abnormal of the online lithium battery cabinet.
Battery EOD	The battery has reached the end of discharge and mains/utility power is unavailable. Restore the mains power. The UPS will power off if it is not restored.
Battery low pre-warning	This alarm occurs when the battery approaches the EOD. After the pre-warning, the battery capacity allows two minutes discharge at full load. The user can set the time with the Low Battery Time setting in Battery settings from 2 - 30 minutes (2 minutes is default). This allows for any loads to be shut down before the system powers off if utility power cannot be restored.
Battery mode	The UPS operating in battery mode. The alarm will clear when utility power is restored.
Battery No. exceed the limit	The number of batteries connected in parallel exceeds the upper limit (unit Support at most one kit and eight EBCS). Remove the excess battery.

Table 6.1 Alarm Messages (continued)

Message	Description
Battery temperature abnormal	Battery Temperature Abnormal of the online Lithium Battery Cabinet.
Battery SN code abnormal	The battery serial number is incorrect or the battery serial number is repeated.
Battery wait for charging	The battery temperature exceeds the normal chargeable range and needs to wait for the temperature to decrease.
Battery wake up manually	Wake up lithium battery manually.
Battery unmatched with the unit	The warning is triggered when the online lithium battery cabinet can't be used by the UPS.
Battery replacement timeout	The system time is past the time set for the batteries to be replaced. If you have disabled the "Batt. note duration" or have no batteries installed, the alarm will not occur.
Battery test fail	The voltage of the battery was low when the periodic or manual self test was run. Battery replacement is recommended.
Battery test started	The battery periodic self-test or manual self-test was started. This will display in the log whenever the event occurs.
Battery test stopped	The battery periodic self-test or manual self-test has finished. This will display in the log whenever the event occurs.
Battery to utility transition	The UPS has transferred the load to the mains power from the battery. This will display in the log whenever the event occurs.
Battery voltage abnormal	The battery voltage exceeds the normal range. Check if the battery terminal voltage exceeds the normal range.
Bypass abnormal	May be caused by bypass voltage and frequency outside of range, bypass power-off and incorrect bypass cables connection. Check that the bypass voltage and frequency are within the setting range. Check the bypass cables connection
Bypass abnormal in ECO mode	May be caused by ECO bypass voltage and frequency outside of range, ECO bypass power-off, and incorrect ECO bypass cables connection. Check that the ECO bypass voltage and frequency are within the setting range. Check the bypass cable connection
Bypass mode	The UPS is on bypass. This will clear when the UPS returns to Normal mode.
Bypass over-current	The load is drawing more current than the UPS is rated to supply in bypass mode. Reduce the load.
Charger fault	The charger output voltage is abnormal and the charger is off. Contact Vertiv Technical Support.
Communication fail	Internal communication is abnormal. Check that the communication cables are connected correctly.
DC bus abnormal	The inverter is off due to DC bus voltage out of acceptable range. The load will transfer to bypass if the bypass is available because the bus voltage is outside of the acceptable range.
DC/DC fault	The discharger is faulty, because the bus voltage exceeds the range when the discharger starts. Contact Vertiv Technical Support.
EOD turn off	The inverter is off due to EOD. Check the mains power-off state and restore the mains in time
Fan fault	At least one fan is faulty. Check if the fan is blocked or the cable connection is loose.
Faults cleared	The faults have been cleared using Settings > Controls > Clear faults. This will display in the log whenever the event occurs.

Table 6.1 Alarm Messages (continued)

Message	Description
Guaranteed shutdown	The battery has finished discharging, then system shuts down because Guaranteed Shutdown is enabled (see Guaranteed shutdown in Settings submenu on page 30). This alarm will clear when the UPS is turned on again.
Input abnormal	The rectifier and charger are off due to the mains voltage and frequency exceeding the normal range. Check that the rectifier input phase voltage and frequency exceed the normal range or that the mains has power-off.
Input ground lost	Check that the PE line is well connected and that the alarm can be cleared at the display.
Input phase reversed	The mains input line and neutral are reversed. Shut off external input breaker and connect the lines correctly.
Insufficient capacity to start	The UPS is on bypass and is started with a load greater than 105% of the rated capacity. Reduce the load to the rated capacity or below to start the unit.
Inverter fault	The inverter is turned off when the inverter output voltage or current exceed the ranges set. If bypass is available, the UPS will transfer to bypass mode, otherwise the system will power off. Contact Vertiv Technical Support.
Inverter overload	Inverter load capacity is larger than the rated value, overload delay time is up, inverter shuts down. If bypass is available, the system will transfer to the bypass mode, otherwise the system will power off. Check the output load. If overloaded, reduce the load, and the system will transfer to the inverter mode after five seconds with no alarm.
Load off due to output short	A short has occurred on the output. Check the output cables and for any equipment that may have shorted.
Load off due to shutdown on battery	The system was shut down in battery mode. This will clear when the system is turned back on.
Manual power- on	The system was turned on via the display panel. This will display in the log whenever the event occurs.
Manual shutdown	The system was shut down via the display panel. This will display in the log whenever the event occurs.
Manual shut-off	Displayed when the user shuts-down UPS output. This will display in the log whenever the event occurs.
No battery	No battery detected. Check the battery and battery cable connections.
Operating on inverter	The UPS output is being powered by the inverter. This will display in the log whenever the event occurs.
Output disabled	The system is in standby state and the dry contact shutdown is enabled. Check if the shutdown dry contact is enabled.
Output off due to bypass abnormal	The bypass voltage or frequency is outside the acceptable range, and the bypass is in standby mode. Check that the input is normal.
Output off due to overload & bypass abnormal	The output is off due to an overload of the UPS output, and the bypass voltage or frequency is outside the acceptable range. Check that the input is normal.
Output off, voltage is not zero	This occurs when the output is off and the system detects that there is still voltage on the output. Check output equipment for backfeeds or contact Vertiv Technical Support.
Output pending	Remote shutdown has been initiated, and the system will turn off shortly.
Output short	A short has occurred on the output. Check the output cables and for any equipment that may have shorted.
Output voltage abnormal	The output voltage is outside the normal voltage range. The UPS will power off. Check output settings or contact Vertiv Technical Support.
Rectifier fault	The rectifier is off because the bus voltage is out of the acceptable range when the rectifier starts. Contact Vertiv Technical Support.
Rectifier overload	The output power is larger than the rectifier overload point. Check that the input voltage meets the output load, mains input 176-100 V, the load 100-50 % linear derating.

Table 6.1 Alarm Messages (continued)

Message	Description
Remote power-on	The UPS was powered on remotely. This will display in the log whenever the event occurs.
Remote shut-off	The UPS was powered off remotely. This will display in the log whenever the event occurs.
Remote shutdown	Any mode shutdown was initiated by the dry contact input. This will display in the log whenever the event occurs.
REPO	Shutdown caused by the REPO terminal Normally-Closed contact input opening. This will display in the log whenever the event occurs.
Restore factory defaults	On the Maintenance page, "Restore Factory Defaults" has been set while the UPS is in the stand-by state. This will return settings to their factory settings.
Shutdown due to over temp	During the UPS operation, the system checks if the heat sink temperature exceeds the setting range. If an overtemperature occurs, check for the following: <ul style="list-style-type: none"> • The ambient temperature is too high. • Dust is blocking any of the UPS vents. • A fan fault has occurred.
System fault	This alarm occurs when the model configuration is incorrect. Contact Vertiv Technical Support.
System over temp	The internal heat-sink temperature is too high, and the inverter is off. The alarm can only be silenced if the heat-sink temperature is lower than the alarm setting. The system can automatically start after overtemperature fault is corrected. If an overtemperature occurs, check for the following: <ul style="list-style-type: none"> • The ambient temperature is too high. • Dust is blocking any of the UPS vents. • A fan fault has occurred.
Turn on fail	The UPS does not start because there is no mains/utility power or it is outside of the range of the voltage required to supply the full load. Check the AC input power.
UPS has no output	Both Inverter and Bypass are not supplying power due to the UPS output being turned off remotely or via the LCD, or are unavailable due to no input power or input power out of range. Check that UPS is on and input power is available.

5.2.7 About screen

The About screen offers tabs that list information about the product.

- Product tab — Displays UPS identification information, firmware versions, and information about the communication card (when the card is installed).
- Efficiency tab — Displays the efficiency curve of the UPS vs the load, output load percentage, and efficiency at that load percentage.
- BMS FW Version—Displays the firmware version for the internal battery and external battery cabinets, if connected.
- BMS SN — Displays the serial number for the internal battery and external battery cabinets, if connected.

To view the product, efficiency, and battery age information:

1. At the main menu, select the About icon, and press *Enter*.
2. Use the arrow buttons to move the cursor left/right and select a tab, then press *Enter* to display the information for the selected tab.

Figure 6.3 About Screen Tabs

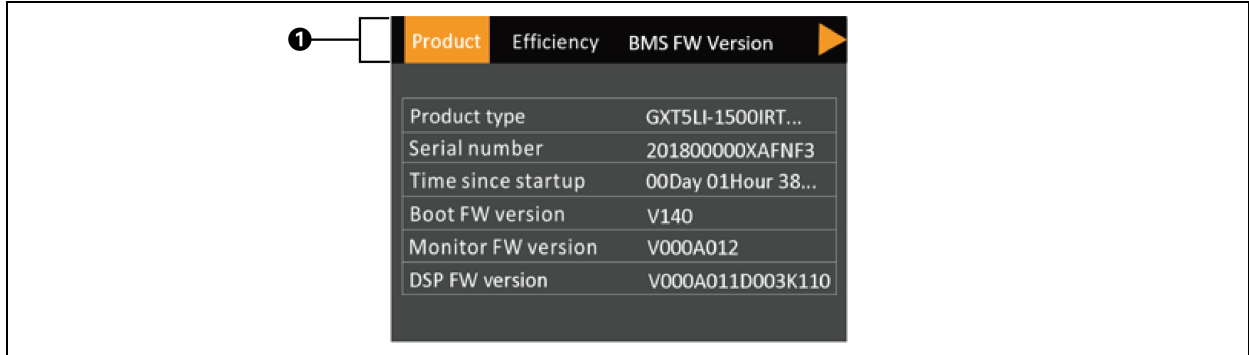

Item	Description
1	About screen tabs with Product tab selected. NOTE: The tab shown in the figure is an example of the information available and may not represent the actual information for your UPS model.

Product

- **Product Type:** UPS model number.
- **Serial number:** UPS serial number.
- **Time since startup:** Elapsed time since startup of the UPS.
- **Boot FW version:** Version of MCU boot firmware on the monitor board.
- **Monitor FW version:** Version of MCU application firmware on the monitor board.
- **DSP FW version:** Version of DSP firmware on the UPS power module.
- **MAC address:** Shows the MAC address of the RDU101 card. This is only shown when the RDU101 card is installed.
- **IPv4 address:** Shows the IPv4 address of the RDU101 card. This is only shown when the RDU101 card is installed.
- **Subnet mask:** Shows the subnet mask of the RDU101 card. This is only shown when the RDU101 card is installed.
- **Gateway address:** Shows the gateway address of the RDU101 card. This is only shown when the RDU101 card is installed.

Efficiency

- **Capacity:** This shows the maximum capacity of the UPS model.
- **Cap. (%):** This shows the percentage of the maximum capacity the UPS is currently using.
- **Eff. (%):** This shows the efficiency the UPS is currently operating at based on the Cap. (%) value.

BMS FW Version

- **Lithium Battery#:** Displays the battery firmware version for the internal battery. If external battery cabinets are connected additional firmware versions will populate.

BMS SN

- **Lithium Battery#:** Displays the internal battery serial number. If external battery cabinets are connected additional serial numbers will populate.

5.3 Editing Display and Operation Settings

Adjust the display settings and UPS configuration via the LCD. The display and operation settings are password protected. The default password is 111111 (six ones).

NOTE: We recommend to change the password to protect your system and equipment and record the new password and store it in an accessible location for later retrieval. See [Changing the password](#) on the next page .

To enter the password:

1. Press the *Up* arrow button to change the digit, then press the *Down* arrow button to move to the next digit.
2. Repeat to select each digit, and press *Enter* to submit the password.

Figure 6.4 Password Prompt

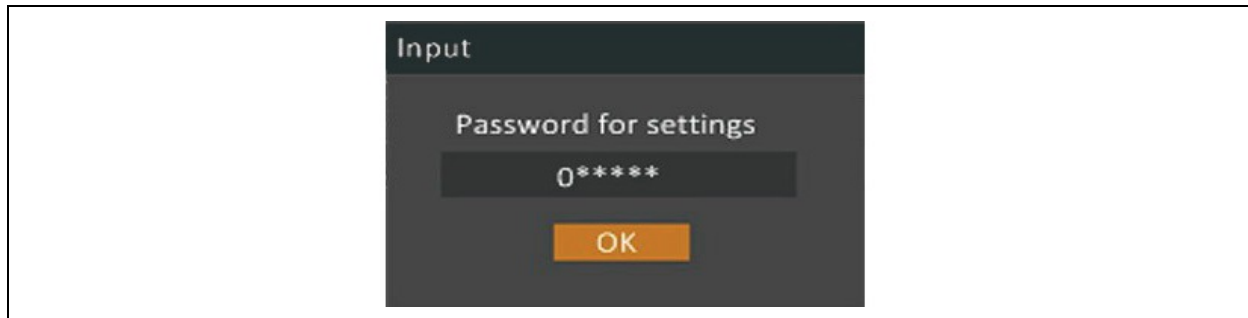

5.3.1 Settings prompts

While using the operation and display panel, prompts display to alert the user to specific conditions or prompts confirmation of commands or settings. **Table 6.2** below lists the prompts and the associated meaning.

Table 6.2 Display Prompts and Meanings

Prompt	Meaning
Cannot set this online, please shut down output	Appears when changing important output settings (output voltage, output frequency, output phase No.).
Incorrect password, please input again	Appears when the Settings password is input incorrectly.
Operation failed, condition is not met	Appears when attempting to execute a operation for which the required conditions are not met.
Password changed OK	Appears upon successful change of the Settings password.
Fail to change password, please try again	Appears when attempting to change the Settings password but the new and confirmation passwords do not match.
The time cannot be earlier than system time	Appears when attempting to set the time of 'Turn on delay' or 'Turn off delay' earlier than the current system time.
Turn on failed, condition is not met	Appears when proper conditions are not met for UPS power on. Applies when using the power button or when execute the command of 'Turn on/Turn off/to Bypass' on the LCD panel 'Control' page).
Cannot set this on line, please unplug REPO	Appears when attempting to change the output phase number while the output is connected.

5.3.2 Changing the password

The default password is 111111 (six ones). Use the current password to change the password.

NOTE: We recommend to change the password from the default to protect your system and equipment. Record the new password and store it in an accessible location for later retrieval.

1. At the main menu, select the Settings icon, and press *Enter*.
2. At the password prompt, use the *Up* arrow to select the first digit, press the *Down* arrow to move to the next digit, repeat for each digit, then press *Enter* to access the settings.
3. Use the arrow buttons to select the Monitor tab, then press *Enter*.
4. Use the *Down* arrow to highlight *Change settings password*, press *Enter*, and enter the current password again.

The Input new password dialog opens, see **Figure 6.5** below

5. Enter the new password, then confirm the new password.

A confirmation dialog opens to indicate a successful password change.

6. Press *ESC* to return to the settings or main menu.

Figure 6.5 New and Confirm Password Dialog Boxes



5.3.3 Selecting the display language

The LCD is multilingual. The available languages are listed below:

- English
- French
- Portuguese
- Spanish
- Chinese
- German
- Japanese
- Italian
- Czech
- Russian

To change the language:

1. At the main menu, select the Settings icon, and press *Enter*.

2. At the password prompt, use the *Up* arrow to select the first digit, press the *Down* arrow to move to the next digit, repeat for each digit, then press *Enter* to access the settings.
3. Use the arrow buttons to select the Monitor tab, then press *Enter*.
4. Use the down arrow to highlight Language, then press *Enter*.
5. Use the *Up/Down* arrows to select the language, then press *Enter*.

All the LCD elements will now display in the selected language.

5.3.4 Setting the date and time

To adjust the date and time:

1. At the main menu, select the Settings icon, and press *Enter*.
2. At the password prompt, use the *Up* arrow to select the first digit, press the *Down* arrow to move to the next digit, repeat for each digit, then press *Enter* to access the settings.
3. Use the arrow buttons to select the Monitor tab, then press *Enter*.
4. Use the down arrow to highlight Date or Time, then press *Enter*.
5. Use the *Up/Down* arrows to select the date/time, then press *Enter* to confirm.
6. Use the down arrow to select the digit to change and the up arrow to select the correct digit. Repeat as needed to set each digit.

This page intentionally left blank

6 Maintenance



WARNING! Risk of electric shock. Can cause equipment damage, injury and death. A battery can present a risk of electrical shock and high shortcircuit current.



WARNING! Risk of electric shock. Can cause injury or death. Hazardous mains and/or battery voltage exists behind the protective cover. No user accessible parts are located behind the protective covers that require a tool for removal. Only qualified service personnel are authorized to remove such covers. If maintenance for rack is needed, notice that the neutral line is live.

Observe the following precautions when working on batteries:

- Remove watches, rings and other metal objects.
- Use tools with insulated handles.
- Wear rubber gloves and boots.
- Do not lay tools or metal parts on top of batteries.
- Disconnect charging source prior to connecting or disconnecting battery terminals.
- If the battery kit is damaged in any way or shows signs of leakage, contact the Vertiv representative immediately.
- Handle, transport, and recycle batteries in accordance with local regulations.
- Determine, if the battery is inadvertently grounded. If it is inadvertently grounded, remove the source of the ground. Contact with any part of a grounded battery can result in electrical shock. The likelihood of such shock will be reduced if grounds are removed during installation and maintenance (applicable to a UPS and a remote battery supply not having a grounded supply circuit).

6.1 Replacing Batteries



WARNING! Risk of electric shock. Can cause injury or death. Disconnect all local and remote electric power supplies before working with the UPS. Ensure that the unit is shut down and power has been disconnected before beginning any maintenance.



WARNING! Risk of electric shock and explosion. Can cause equipment damage, injury and death. Do not dispose of the battery in a fire. The battery may explode. Do not open or damage the battery. Released electrolyte is toxic and is harmful to skin and eyes. If electrolyte comes into contact with the skin, wash the affected area immediately with plenty of clean water and get medical attention.



WARNING! Risk of electric shock. Can cause equipment damage, injury and death. A battery can present a risk of electrical shock and high short circuit current.



WARNING! Risk of explosion. Can cause equipment damage, injury and death. A battery can explode if the battery is replaced by an incorrect type. Dispose of used batteries according to the instructions included with the battery pack.

Read all safety cautions before proceeding. A trained user can replace the internal battery pack when the UPS is in a restricted access location (such as a rack or server closet). To obtain the appropriate replacement battery packs, refer to **Table 7.1** below, and contact the local dealer or Vertiv representative.

Table 7.1 Replacement Battery Pack Model Numbers

UPS Model Number	Battery Pack Model Number	Quantity Required
GXT5LI-1000IRT2UXL	GXT5LI-48VBATKIT1	1
GXT5LI-1500IRT2UXL	GXT5LI-48VBATKIT2	1
GXT5LI-2000IRT2UXL		
GXT5LI-3000IRT2UXL		

To replace a battery pack, refer to the instructions below and see Figure 7.1 on the facing page:

NOTE: The internal battery pack is hot swappable. However, you must exercise caution because; during this procedure, the load is unprotected from disturbances and power outages. Do not replace the battery while the UPS is operating in Battery Mode. This will result in a loss of output power and will drop the connected load.

1. Press the button on the left front of the UPS front panel.
2. Loosen and remove the screw from the battery door. Remove the battery door.
3. Grasp the battery handle, and pull out the battery pack.
4. Unpack the replacement battery pack, taking care not to damage the packaging to reuse when disposing of the old battery. Compare the new and old battery pack to make sure they are the same type and model. If they are different, stop and contact the Vertiv representative, or Technical Support, <http://www.Vertiv.com/en-us/support/>. If the new battery matches the old battery install it in the UPS.
5. Reinstall the battery door and screw.
6. Close the UPS front panel.

Figure 7.1 Replacing the Battery Pack

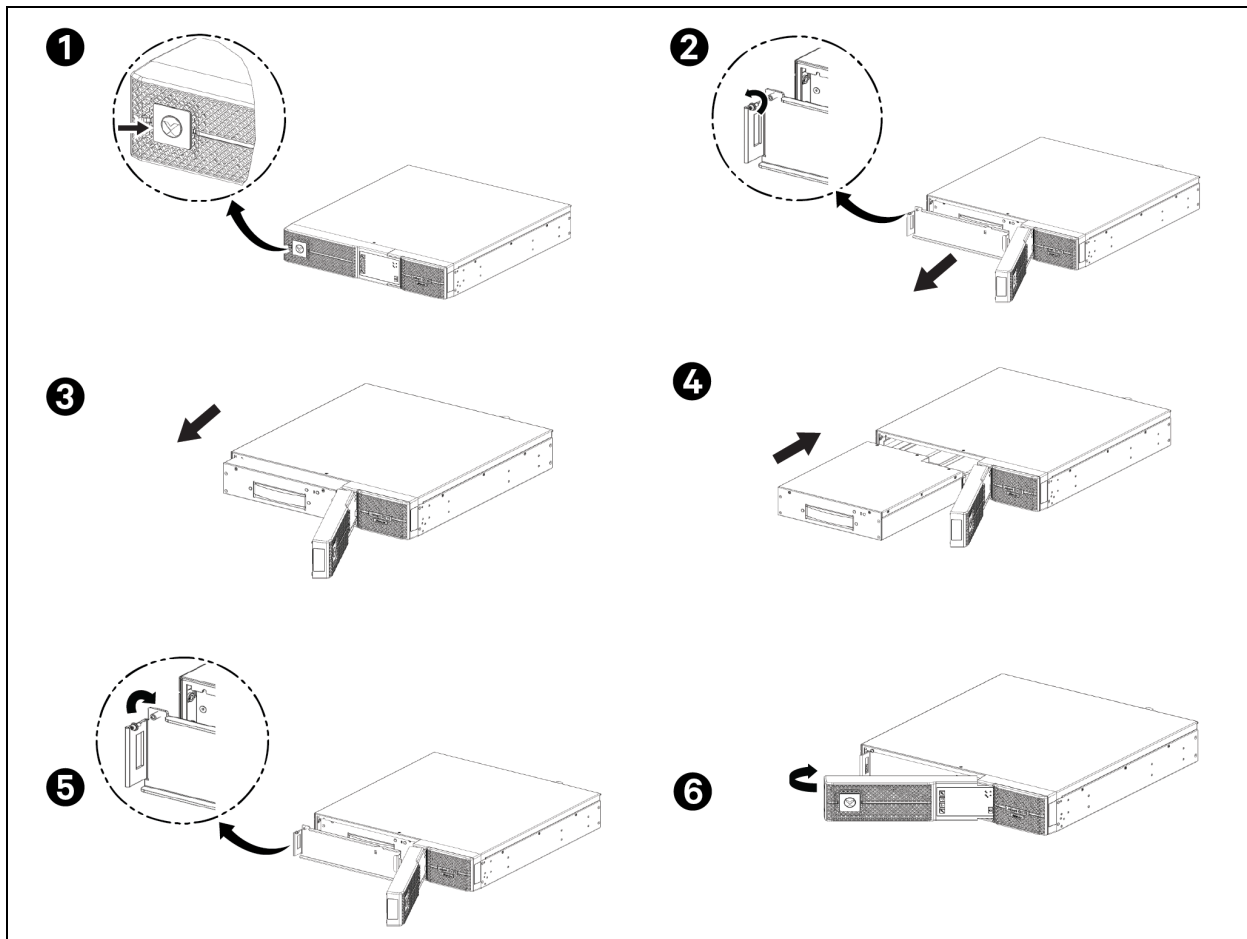

6.2 Charging Batteries

The batteries are LiFePO₄ type Lithium-ion batteries. They should be kept charged to maintain their design life. The Vertiv™ Liebert® GXT5 Lithium-Ion charges the batteries continuously when it is connected to input power. If the UPS will be stored for a long time, Vertiv recommends connecting the UPS to input power every 4 to 6 months for at least 3 hours to ensure recharge of the batteries.

The Lithium-ion batteries used in the Liebert® GXT5 Lithium-Ion series, as well as all Vertiv Lithium-Ion UPSs, contain a Battery Management System (BMS) that self-monitors the safety of the Lithium-ion batteries in real time. This is an agency tested and certified requirement now eliminating the industry wide safety risk known with previous Lithium-ion batteries.

6.3 Checking UPS Operation

NOTE: Operation check procedures may interrupt output power supplied to the connected load.

We recommend checking the UPS operation once every 6 months. Ensure that output power loss to the connected load will not cause data loss or other errors before conducting the check.

1. Press the *Enter* button to check the indicators and display function.
2. Check for alarm or fault indicators on the operation/display panel.

3. Make sure that there are no audible or silenced alarms. Select the Log, and look at the Current tab for alarm and fault history, see [Log screen](#) on page 37.
4. Check the flow screen to ensure the UPS is operating in Normal mode. If the UPS is operating in Bypass mode, contact Vertiv Technical Support.
5. Check the flow screen to see if batteries are discharging (operating in Battery mode) while utility power is normal. If so, contact Vertiv Technical Support.

6.4 Cleaning the UPS



WARNING! Risk of electric shock. Can cause injury or death. Disconnect all local and remote electric power supplies before working with the UPS. Ensure that the unit is shut down and power has been disconnected before beginning any maintenance.



WARNING! Risk of electric shock. Can cause injury or death. Hazardous mains and/or battery voltage exists behind the protective cover. No user accessible parts are located behind the protective covers that require a tool for removal. Only qualified service personnel are authorized to remove such covers. If maintenance for rack is needed, notice that the neutral line is live.

The UPS requires no internal cleaning. If the outside of the UPS becomes dusty, wipe with a dry cloth. Do not use liquid or aerosol cleaners. Do not insert any objects into the ventilation holes or other openings in the UPS.

6.5 Installing or Replacing Optional Dust Filter

Optional dust filters are available for the Vertiv™ Liebert® GXT5 Lithium-Ion. See the instructions below for installing or replacing the dust filter.

1. Pull the right/top bezel to the right to remove the bezel. See **Figure 7.2** below.
2. Remove the dust filter (if applicable).
3. Install a new dust filter (part number 21101867).
4. Reinstall the right/top bezel.

Figure 7.2 Right/Top Bezel Removal

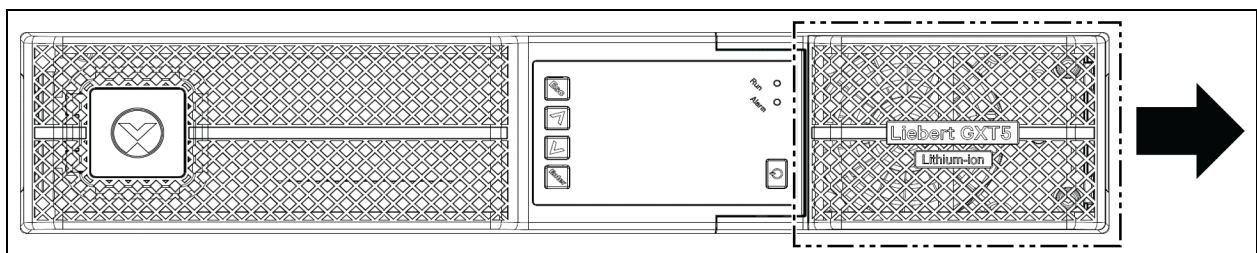

6.6 Firmware Updates

The UPS has three firmware components:

- DSP is the firmware for the power module.
- MCU is the firmware for the display panel.
- BMS is the firmware for the lithium-ion battery management system. This will appear for the internal battery and any connected external battery cabinets.

All firmware components may be updated using either CLI and the RS232 port, or the RJ-45 port on the RDU101 card, if installed.

The latest firmware files and update instructions are available for download under UPS Product Downloads on Vertiv's Software Downloads page at <https://www.vertiv.com/en-us/support/software-downloads/>.

This page intentionally left blank

7 Troubleshooting

This section contains various UPS symptoms that you may encounter if UPS develops a problem. Use the information mentioned in this section to determine the causes and the solutions to those problems.

7.1 Symptoms that Require Troubleshooting

The following symptoms indicate the UPS is malfunctioning:

- The alarm indicators illuminate, indicating the UPS has detected a problem.
- An alarm buzzer sounds, alerting the user that the UPS requires attention.

7.2 Audible Alarm (Buzzer)

An audible alarm accompanies various events during UPS operations. **Table 8.1** below, describes the sounds and their meaning. To mute an alarm, see [Silencing the Audible Alarm](#) on page 23.

Table 8.1 Audible Alarm Descriptions

Sound	Indicates
Continuous beep	Generated when a UPS fault appears, such as a fuse or hardware failure.
One beep every 0.5 seconds	Generated when a UPS critical alarm appears, such as on inverter overload.
One beep every 1 second	Generated when a UPS critical alarm appears, such as on battery low voltage.
One beep every 3.3 seconds	Generated when a UPS general alarm appears.

NOTE: When an alarm is indicated, an alarm message is logged. **Table 6.1** on page 38, describes the alarm messages you may see. When a fault is indicated, front-panel display list the fault, which are described in **Table 8.2** on the next page.

7.2.1 Faults

When the fault indicator is illuminated, the LCD displays the fault. The faults are described in **Table 8.2** on the next page.

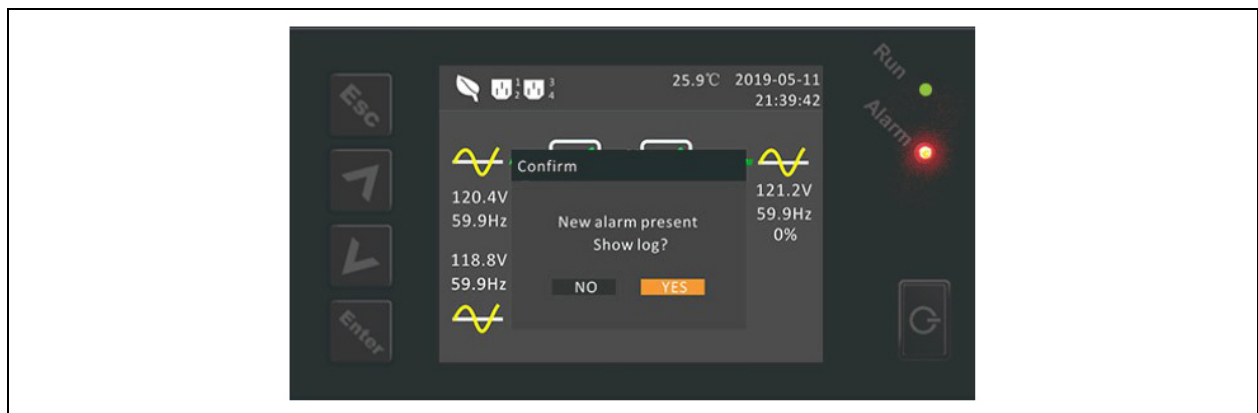

Table 8.2 Description of Displayed Faults

Displayed Fault	Cause	Corrective Actions
Rectifier fault	A rectifier failure occurred.	Contact technical support.
Inverter fault	The inverter is faulty.	Contact technical support.
Output short	The output connection is short-circuited.	Shut-down the equipment and contact technical support.
DC bus abnormal	The DC bus is faulty.	Contact technical support.
Charger fault	The charger is faulty.	Contact technical support.
DC/DC fault	A DC-DC charger failure occurred.	Contact technical support.
Aux power fault	An Aux power failure occurred.	Contact technical support.
Output off, voltage is not zero	Incorrect input, output and ground wiring.	Contact technical support.
System fault	Model is not set.	Contact technical support.
Communication fail	Appears when the communication is abnormal.	Contact technical support.

7.3 Troubleshooting UPS Issues

In the event of an issue with the UPS, see **Table 8.3** below to determine the cause and solution. If the fault persists, contact Vertiv Technical Support. Visit the Vertiv™ Liebert® GXT5 Lithium-Ion product page at www.vertiv.com for contact information.

When reporting a UPS issue to Vertiv, include the UPS model and serial number. These are located in several places for your ease of location:

- On the top panel (rack mount orientation)
- The left side (tower orientation)
- The rear panel
- On the LCD select Main Menu > About

Table 8.3 Troubleshooting

Problem	Cause	Solution
UPS fails to start	UPS is short- circuited or overloaded	Ensure UPS is Off. Disconnect all loads and ensure nothing is lodged in output receptacles. Ensure loads are not defective or shorted internally.
	Batteries are not charged enough or not connected	Check to ensure the internal battery is connected. If it is not, fully remove and reinstall the battery, and try to start the unit. If the battery is connected, leave the UPS connected to input power for 24 hours to recharge batteries, then try to start the unit.
UPS has reduced battery backup time	Batteries are not fully charged	Keep UPS plugged in continuously at least 24 hours to recharge batteries.
	UPS is overloaded	Check load level indicator and reduce the load on the UPS.
	Batteries may not be able to hold a full charge due to age	Replace batteries. Contact your Vertiv representative or Vertiv Technical Support for replacement battery kit.

8 Specifications

Table 9.1 UPS Specifications

Model	GXT5LI-1000IRT2UXL	GXT5LI-1500IRT2UXL	GXT5LI-2000IRT2UXL	GXT5LI-3000IRT2UXL
Rating	1000 VA/1000 W	1500 VA/1500 W	2000 VA/2000 W	3000 VA/2700 W
Dimensions, W×D×H, inches (mm)				
Unit	16.9 x 17.5 x 3.3 (2U) (430 x 446 x 85)	16.9 x 18.7 x 3.3 (2U) (430 x 476 x 85)		16.9 x 21.5 x 3.3 (2U) (430 x 546 x 85)
Shipping	21.3 x 23.0 x 9.0 (542 x 583 x 228)	21.3 x 23.0 x 9.0 (542 x 583 x 228)		21.3 x 27.7 x 9.0 (542 x 703 x 228)
Weight, lb.(kg)				
Unit	33.1 (15.0)	38.6 (17.5)		43.0 (19.5)
Shipping	48.9 (22.2)	52.9 (24)		59.7 (27.1)
Power Rating				
240 VAC Output	1000 VA / 1000 W	1500 VA / 1500 W	2000 VA / 2000 W	3000 VA / 2700 W
230 VAC Output				
220 VAC Output				
208 VAC Output	900 VA / 900 W		1800 VA / 1800 W	
200 VAC Output				
Input AC				
Voltage (typical)	230 VAC nominal, variable based on output load			
90% ~ 100% loading	161-176 VAC/288 VAC			
70% ~ 90% loading	130-161 VAC/288 VAC			
50% ~ 70% loading	100-130 VAC/ 288 VAC			
0 ~ 50% loading	100 VAC - 288 VAC			
Frequency	40 - 70 Hz; auto sensing			
Input Power Receptacle	C14		C20	
Output AC				
Output Receptacles	C13 x 8 (6 programmable)			C13 x 6 (4 programmable) C19 x 1

Table 9.1 UPS Specifications (continued)

Model	GXT5LI-1000IRT2UXL	GXT5LI-1500IRT2UXL	GXT5LI-2000IRT2UXL	GXT5LI-3000IRT2UXL
Rating	1000 VA/1000 W	1500 VA/1500 W	2000 VA/2000 W	3000 VA/2700 W
Voltage	200/208/220/230/240 VAC (user-configurable); ±3%			
Waveform	Sine wave			
Utility (AC) Model Overload	>200% for 250 ms 150-200% for 2 seconds 125-150% for 50 seconds 105-125% for 60 seconds			>200% for 250 ms 150-200% for 2 seconds 105-150% for 55 seconds
Internal Charger				
Charging current	Nominal 3 A; Maximum 8 A (with external battery)	Nominal 4.5 A; Maximum 8 A (with external battery)		
Battery				
Type	Lithium-ion (LiFePO4)			
Configuration x V x Ah	2P16S x 48V x 6Ah	3P16S x 48V x 9Ah		
Backup time	See Battery Run Times on page 59.			
Recharge Time	2 Hours to 90% capacity after full discharge with 100% load until UPS auto shutdown (Internal Batteries Only). See Table 9.8 on page 61 for external battery cabinet recharge times.			
Replacement Battery	GXT5LI-48VBATKIT1	GXT5LI-48VBATKIT2		
Environmental Requirements				
Operating Temperature (full rating), °F (°C)	32-104 °F (0-40 °C)			
Extended Operating Temperature °F (°C)	32-122 °F (0-50 °C) For 104-122 °F (40-50 °C) output derated by 1% per 1.8 °F (1 °C)			
Storage Temperature, °F (°C)	-4 to 140 °F (-20 to 60 °C) without batteries -4 to 113 °F (-20 to 45 °C) with batteries			
Relative Humidity	0 - 95%, non condensing			
Operating Elevation	Up to 10000 ft (3000 m) at 77 °F (25 °C) without derating			
Audible Noise	<46 dBA max @ 3 ft (1 m) front and sides <43 dBA max @ 3 ft (1 m) rear	<46 dBA max @ 3 ft (1 m) front and sides <45 dBA max @ 3 ft (1 m) rear	<48 dBA max @ 3 ft (1 m) front and sides <48 dBA max @ 3 ft (1 m) rear	<48 dBA max @ 3 ft (1 m) front and sides <48 dBA max @ 3 ft (1 m) rear

Table 9.2 UPS Certification

Model	GXT5LI-1000IRT2UXL	GXT5LI-1500IRT2UXL	GXT5LI-2000IRT2UXL	GXT5LI-3000IRT2UXL
Agency	CE, TUV, Energy Star			
Safety	IEC 62040-1:2008+A1 2013 IEC62619 Edition1.0 (for battery pack and cell) UL1973&UL1642 (for battery pack and cell)			
EMC	Emission (Low limits – Conducted and radiated): IEC/EN/AS 62040-2 2nd Ed (Cat2 – Table 1) CISPR22 Class A (RFI) IEC 61000-3-2,IEC 61000-3-12 (Harmonics) Immunity (High commercial and light industry immunity levels for enclosure, power, signal and control ports): IEC/EN/AS 62040-2 2nd Ed (Cat 2 – Table 6) for IEC/EN/AS: 61000-4-2 Electrostatic discharge 61000-4-3 Radiated E-RFI fields 61000-4-4 Fast E transients 61000-4-5 Surges/Lightning 61000-4-6 Conducted RFI			
Transportation	ISTA 2A for individually packaged ISTA 3E for palletized units UN3480			
Surge Immunity	ANSI C62.41 Category B IEC 61000-4-5			
RFI/EMI	CISPR22 Class A (RFI)			

Table 9.3 External Battery Specifications

Model	VEBCLI-48VRT1U
Used With UPS Model	GXT5LI-1000/1500/2000/3000IRT2UXL
Dimensions, W×D×H, inches (mm)	
Unit	16.9 x 17.5 x 1.7 (1U) (430 x 446 x 42.5)
Shipping	23.6 x 31.5 x 11.7 (600 x 800 x 297)
Weight, lb.(kg)	
Unit	21.8 (9.9)
Shipping	56.2 (25.5)
Battery	
Type	Lithium-ion LiFePO4
Configuration x V x Ah	3P16S x 48 V x 9 Ah
Backup time	See Battery Run Times on page 59
Electrical Protection	
Breaker size	80 A
Environmental Requirements	
Operating Temperature, °F (°C)	32-122 °F (0-50 °C)

Table 9.3 External Battery Specifications (continued)

Model	VEBCL1-48VRT1U
Used With UPS Model	GXT5LI-1000/1500/2000/3000IRT2UXL
Storage Temperature, °F (°C)	-4 to 113 °F (-20 to 45 °C)
Relative Humidity	0% - 95%, non condensing
Operating Elevation	Up to 10000 ft (3000 m) at 77 °F (25 °C) without derating
Agency	
Safety	IEC62619 Edition1.0 (for battery pack and cell) UL1973&UL1642 (for battery pack)
EMC	Emission (Low limits – Conducted and radiated): IEC/EN/AS 62040-2 2nd Ed (Cat2 – Table 1) CISPR22 Class A (RFI) IEC 61000-3-2, IEC 61000-3-12 (Harmonics) Immunity (High commercial and light industry immunity levels for enclosure, power, signal and control ports): IEC/EN/AS 62040-2 2nd Ed (Cat 2 – Table 6) for IEC/EN/AS: 61000-4-2 Electrostatic discharge 61000-4-3 Radiated E-RFI fields 61000-4-4 Fast E transients 61000-4-5 Surges/Lightning 61000-4-6 Conducted RFI
Transportation	ISTA 3E for palletized units UN3480
Surge Immunity	ANSI C62.41 Category B IEC 61000-4-5
RFI/EMI	CISPR22 Class A (RFI)

8.1 Battery Run Times

NOTE: Run times in this table are approximate. They are based on new, fully charged batteries at 77°F (25°C), with fully resistive loads. Run times can vary ±5% due to manufacturing variances.

Table 9.4 Battery Run Time in Minutes, GXT5LI-1000IRT2UXL

Load			Internal Battery Only	Number of External Battery Cabinets							
%	VA	W		1	2	3	4	5	6	7	8
10	100	100	107	269.5	435	600	765	930	1095.5	1260.5	1425.5
20	200	200	62	154.5	249.5	345	440	535.5	630.5	726	821
30	300	300	42	106.5	174	241.5	308.5	376	443.5	510.5	578
40	400	400	31.5	80	131.5	183	234.5	286	337.5	389	440.5
50	500	500	26.5	68	112	156	200	244.5	288.5	332.5	376.5
60	600	600	22	56	93	130	167.5	204.5	241.5	278.5	315.5
70	700	700	18.5	48	79.5	111.5	143.5	175.5	207.5	239.5	271.5
80	800	800	16	41.5	69.5	97.5	125.5	153.5	181.5	209.5	238
90	900	900	13.5	36	60.5	85.5	110	135	159.5	184.5	209
100	1000	1000	12	32	54	76.5	99	121	143.5	166	188

Table 9.5 Battery Run Time in Minutes, GXT5LI-1500IRT2UXL

Load			Internal Battery Only	Number of External Battery Cabinets							
%	VA	W		1	2	3	4	5	6	7	8
10	150	150	104.5	212	319.5	427	534	641.5	749	856.5	964
20	300	300	63.5	130	196.5	263.5	330	396.5	463	529.5	596
30	450	450	44	91.5	138.5	185.5	232.5	280	327	374	421
40	600	600	34	71	108	145.5	182.5	219.5	256.5	293.5	330.5
50	750	750	27	57	86.5	116.5	146.5	176.5	206.5	236	266
60	900	900	22	47	72	97.5	122.5	147.5	172.5	197.5	222.5
70	1050	1050	18	39	60	81.5	102.5	123.5	144.5	165.5	186.5
80	1200	1200	15.5	34	52.5	71	89.5	108	126.5	145	163.5
90	1350	1350	14	31	48	65.5	82.5	99.5	116.5	133.5	150.5
100	1500	1500	13	28	43.5	59.5	75	90.5	106	121.5	137

Table 9.6 Battery Run Time in Minutes, GXT5LI-2000IRT2UXL

Load			Internal Battery Only	Number of External Battery Cabinets							
%	VA	W		1	2	3	4	5	6	7	8
10	200	200	89	181	273	365	456.5	548.5	640.5	732.5	824.5
20	400	400	49	101	153.5	205.5	257.5	309.5	361.5	413.5	465.5
30	600	600	36	74.5	113.5	152	190.5	229.5	268	307	345.5
40	800	8000	26.5	56	85	114.5	144	173	202.5	232	261.5
50	1000	1000	21	44.5	68	91.5	115.5	139	162.5	186	210
60	1200	1200	17	36.5	56.5	76	96	116	135.5	155.5	175
70	1400	1400	14	31	48	65	82	99	116	133	150
80	1600	1600	12	27	42	57	71.5	86.5	101.5	116.5	131.5
90	1800	1800	10.5	23.5	36.5	49.5	63	76	89	102	115.5
100	2000	2000	9	21	32.5	44.5	56.5	68	80	92	103.5

Table 9.7 Battery Run Time in Minutes, GXT5LI-3000IRT2UXL

Load			Internal Battery Only	Number of External Battery Cabinets							
%	VA	W		1	2	3	4	5	6	7	8
10	300	270	70.5	144	217	290.5	364	437	510.5	584	657.5
20	600	540	37.5	78	118.5	159	199.5	240.5	281	321.5	362
30	900	810	25	53	81.5	109.5	137.5	165.5	193.5	221.5	249.5
40	1200	1080	18.5	39.5	60.5	82	103	124.5	145.5	166.5	188
50	1500	1350	14	31	48	65.5	82.5	99.5	116.5	133.5	150.5
60	1800	1620	12	26.5	41.5	56	71	85.5	100	115	129.5
70	2100	1890	10	22.5	35	47.5	60.5	73	85.5	98.5	111
80	2400	2160	8.5	19.5	30.5	41.5	52.5	63.5	75	86	97
90	2700	2430	7	17	27	36.5	46.5	56.5	66	76	86
100	3000	2700	6.5	15	24	32.5	41.5	50.5	59.5	68.5	77

Table 9.8 External Battery Cabinet Recharge Times

Number of EBCs	Charging time to 100% (Hours)	Charge Current
1	3	8A
2	4.25	
3	5.5	
4	6.75	
5	8	
6	9.25	
7	10.25	
8	11.75	

Appendices

Appendix A: Technical Support

Our Technical Support staff is ready to assist you with any installation or operating issues you may encounter with your Liebert® product. Visit <https://www.vertiv.com/en-us/support/> for additional assistance. Alternatively, please call or email us:

In Europe, Middle East, and Africa (EMEA)

Multi-language technical support and warranty

Email: warranty.channel.emea@vertiv.com

Phone: Toll free 0080011554499

Asia-Pacific (APAC)

Technical support and warranty

Email: DPG.Warranty@vertiv.com

Phone: Australia: 1300-367-686 option 1

Phillipines: 620-3655 option 2

Singapore: 1800-467-2326 option 2

Malaysia: 1800-221-388

United States/Canada

UPS technical support

Email: liebert.upstech@vertiv.com

Phone: 1-800-222-5877 menu option 1

Software and monitoring technical support

Email: liebert.monitoring@vertiv.com

Phone: 1-800-222-5877 menu option 2

Warranty support

Email: microups.warranty@vertiv.com

Phone: 1-800-222-5877 menu option 3

Latin America

Technical support and warranty

Peru:

Email: CallCenter.Peru@vertiv.com

Phone: 0800 - 77737

Chile:

Email: CallCenter.Chile@vertiv.com

Phone: 800 - 395429

Argentina:

Email: CallCenter.Argentina@vertiv.com

Phone: 0800 - 1220869

Columbia:

Email: CallCenter.Colombia@vertiv.com

Phone: 018000 - 125527

Mexico:

Email: CallCenter.Mexico@vertiv.com

Phone: 01800 - 2530414

Central America and Caribbean countries:

Email: CallCenter.CA@vertiv.com

Paraguay:

Email: CallCenter.Paraguay@vertiv.com

Uruguay:

CallCenter.Uruguay@vertiv.com

Bolivia:

Email: CallCenter.Bolivia@vertiv.com

Open Source Software Legal Notices

The Vertiv™ Liebert® GXT5 Lithium-Ion product links the FreeRTOS software with Vertiv Group Corporation's proprietary modules that communicate with the FreeRTOS software solely through the FreeRTOS API interface. This use is an exception to the FOSS GPLv2 license. The user is free to redistribute the FreeRTOS software and/or modify it under the terms of the GNU General Public License as published by the Free Software Foundation. A copy of the GNU General Public License is located at www.gnu.org/licenses/old-licenses/gpl-2.0.html. A copy of the exception is located at <https://spdx.org/licenses/freertos-exception-2.0.html>. For a period of three (3) years after purchasing the Liebert® GXT5 Lithium-Ion product, the purchaser has the right to obtain a copy of the FreeRTOS software that is incorporated in the Liebert® GXT5 Lithium-Ion product.

The purchaser can contact Vertiv Technical Support and request the software.

Connect with Vertiv on Social Media



<https://www.facebook.com/vertiv/>



<https://www.instagram.com/vertiv/>



<https://www.linkedin.com/company/vertiv/>



<https://www.twitter.com/Vertiv/>



Vertiv.com | Vertiv Headquarters, 1050 Dearborn Drive, Columbus, OH, 43085, USA

© 2022 Vertiv Group Corp. All rights reserved. Vertiv™ and the Vertiv logo are trademarks or registered trademarks of Vertiv Group Corp. All other names and logos referred to are trade names, trademarks or registered trademarks of their respective owners. While every precaution has been taken to ensure accuracy and completeness here, Vertiv Group Corp. assumes no responsibility, and disclaims all liability, for damages resulting from use of this information or for any errors or omissions. Specifications, rebates and other promotional offers are subject to change at Vertiv's sole discretion upon notice.