

PRIMERGY TX150 S8 / TX200 S7 Server

Upgrade and Maintenance Manual

Comments... Suggestions... Corrections...

The User Documentation Department would like to know your opinion of this manual. Your feedback helps us optimize our documentation to suit your individual needs.

Feel free to send us your comments by e-mail to manuals@ts.fujitsu.com.

Certified documentation according to DIN EN ISO 9001:2008

To ensure a consistently high quality standard and user-friendliness, this documentation was created to meet the regulations of a quality management system which complies with the requirements of the standard DIN EN ISO 9001:2008.

cognitas. Gesellschaft für Technik-Dokumentation mbH
www.cognitas.de

Copyright and Trademarks

Copyright © 2012 Fujitsu Technology Solutions GmbH.

All rights reserved.

Delivery subject to availability; right of technical modifications reserved.

All hardware and software names used are trademarks of their respective manufacturers.

- The contents of this manual may be revised without prior notice.
- Fujitsu assumes no liability for damages to third party copyrights or other rights arising from the use of any information in this manual.
- No part of this manual may be reproduced in any form without the prior written permission of Fujitsu.

Microsoft, Windows, Windows Server, and Hyper V are trademarks or registered trademarks of Microsoft Corporation in the USA and other countries.

Intel and Xeon are trademarks or registered trademarks of Intel Corporation or its subsidiaries in the USA and other countries.

Before reading this manual

For your safety

This manual contains important information for safely and correctly using this product.

Carefully read the manual before using this product. Pay particular attention to the accompanying manual "Safety Notes and Regulations" and ensure these safety notes are understood before using the product. Keep this manual and the manual "Safety Notes and Regulations" in a safe place for easy reference while using this product.

Radio interference

This product is a "Class A" ITE (Information Technology Equipment). In a domestic environment this product may cause radio interference, in which case the user may be required to take appropriate measures. VCCI-A

Aluminum electrolytic capacitors

The aluminum electrolytic capacitors used in the product's printed circuit board assemblies and in the mouse and keyboard are limited-life components. Use of these components beyond their operating life may result in electrolyte leakage or depletion, potentially causing emission of foul odor or smoke.

As a guideline, in a normal office environment (25°C) operating life is not expected to be reached within the maintenance support period (5 years). However, operating life may be reached more quickly if, for example, the product is used in a hot environment. The customer shall bear the cost of replacing replaceable components which have exceeded their operating life. Note that these are only guidelines, and do not constitute a guarantee of trouble-free operation during the maintenance support period.

High safety use

This product has been designed and manufactured to be used in commercial and/or industrial areas as a server.

When used as visual display workplace, it must not be placed in the direct field of view to avoid incommoding reflections. The device has not been designed or manufactured for uses which demand an extremely high level of safety and carry a direct and serious risk of life or body if such safety cannot be assured.

These uses include control of nuclear reactions in nuclear power plants, automatic airplane flight control, air traffic control, traffic control in mass transport systems, medical devices for life support, and missile guidance control in weapons systems (hereafter, "high safety use"). Customers should not use this product for high safety use unless measures are in place for ensuring the level of safety demanded of such use. Please consult the sales staff of Fujitsu if intending to use this product for high safety use.

Measures against momentary voltage drop

This product may be affected by a momentary voltage drop in the power supply caused by lightning. To prevent a momentary voltage drop, use of an AC uninterruptible power supply is recommended.

(This notice follows the guidelines of Voltage Dip Immunity of Personal Computer issued by JEITA, the Japan Electronics and Information Technology Industries Association.)

Technology controlled by the Foreign Exchange and Foreign Trade Control Law of Japan

Documents produced by Fujitsu may contain technology controlled by the Foreign Exchange and Foreign Trade Control Law of Japan. Documents which contain such technology should not be exported from Japan or transferred to non-residents of Japan without first obtaining authorization in accordance with the above law.

Harmonic Current Standards

This product conforms to harmonic current standard JIS C 61000-3-2.

Only for the Japanese market: About SATA hard disk drives

The SATA version of this server supports hard disk drives with SATA / BC-SATA storage interfaces. Please note that the usage and operation conditions differ depending on the type of hard disk drive used.

Please refer to the following internet address for further information on the usage and operation conditions of each available type of hard disk drive:

<http://jp.fujitsu.com/platform/server/primergy/harddisk/>

Only for the Japanese market:



Although described in this manual, some sections do not apply to the Japanese market. These options and routines include:

- CSS (Customer Self Service)

Version history

Issue number	Reason for update
1.0 / July 2012	Initial release

Contents

1	Introduction	23
1.1	Notational conventions	24
2	Before you start	25
2.1	Classification of procedures	27
2.1.1	Customer Replaceable Units (CRU)	27
2.1.2	Upgrade and Repair Units (URU)	28
2.1.3	Field Replaceable Units (FRU)	29
2.2	Average task duration	29
2.3	Tools you need at hand	30
2.4	Documents you need at hand	32
3	Important information	35
3.1	Safety instructions	35
3.2	CE conformity	43
3.3	FCC Class A Compliance Statement	43
3.4	Environmental protection	44
4	Basic hardware procedures	47
4.1	Using diagnostics information	47
4.1.1	Locating the defective server	47
4.1.2	Determining the error class	48
4.1.2.1	Global Error indicator	48
4.1.2.2	Customer Self Service (CSS) indicator	48
4.1.3	Locating the defective component	49
4.1.3.1	Local diagnostic indicators on the front	49
4.1.3.2	Local diagnostic indicators on the system board	49
4.2	Shutting down the server	50

Contents

4.3	Disconnecting the server from the mains	50
4.4	Getting access to the component	51
4.4.1	Rack model	51
4.4.1.1	Extending the server out of the rack	51
4.4.1.2	Removing the server from the rack	53
4.4.1.3	Removing the top cover	55
4.4.1.4	Removing the rack front cover	56
4.4.2	Tower model	58
4.4.2.1	Unlocking the server	58
4.4.2.2	Removing the side cover	59
4.4.2.3	Removing accessible drive and HDD bay covers	60
4.4.2.4	Removing the front cover	61
4.4.3	Removing the system air duct	63
4.5	Reassembling	64
4.5.1	Installing the system air duct	64
4.5.2	Rack model	65
4.5.2.1	Installing the rack front cover	65
4.5.2.2	Installing the top cover	66
4.5.2.3	Mounting the server in the rack	67
4.5.2.4	Sliding the server into the rack	69
4.5.3	Tower model	70
4.5.3.1	Installing the front cover	70
4.5.3.2	Installing accessible drive and HDD bay covers	71
4.5.3.3	Installing the side cover	72
4.5.3.4	Locking the server	73
4.6	Connecting the server to the mains	74
4.7	Switching on the server	75
4.8	Handling the system fan holder	76
4.9	Handling the anti-tilt bracket	77
4.10	Handling rubber feet	78
5	Basic software procedures	79
5.1	Starting the maintenance task	79
5.1.1	Disabling BitLocker functionality	79
5.1.2	Disabling SVOM boot watchdog functionality	80
5.1.2.1	Viewing boot watchdog settings	80
5.1.2.2	Configuring boot watchdog settings	80

5.1.3	Removing backup and optical disk media	81
5.1.4	Verifying and configuring the backup software solution	82
5.1.5	Note on server maintenance in a Multipath I/O environment	82
5.1.6	Switching on the ID indicator	84
5.2	Completing the maintenance task	85
5.2.1	Updating or recovering the system board BIOS and iRMC	85
5.2.1.1	Updating or recovering the system board BIOS	85
5.2.1.2	Updating or recovering the iRMC	87
5.2.2	Verifying system information backup / restore	89
5.2.3	Updating RAID controller firmware	89
5.2.4	Enabling Option ROM scan	90
5.2.5	Verifying and configuring the backup software solution	91
5.2.6	Resetting the boot retry counter	92
5.2.6.1	Viewing the boot retry counter	92
5.2.6.2	Resetting the boot retry counter	92
5.2.7	Enabling SVOM boot watchdog functionality	94
5.2.8	Enabling replaced components in the system BIOS	95
5.2.9	Verifying the memory mode	95
5.2.10	Verifying the system time settings	96
5.2.11	Viewing and clearing the System Event Log (SEL)	97
5.2.11.1	Viewing the SEL	97
5.2.11.2	Clearing the SEL	98
5.2.12	Updating the NIC configuration file in a Linux environment	98
5.2.13	Enabling BitLocker functionality	100
5.2.14	Performing a RAID array rebuild	101
5.2.15	Looking up changed MAC / WWN addresses	101
5.2.15.1	Looking up MAC addresses	101
5.2.15.2	Looking up WWN addresses	102
5.2.16	Using the Chassis ID Prom Tool	103
5.2.17	Configuring LAN teaming	103
5.2.17.1	After replacing / upgrading LAN controllers	104
5.2.17.2	After replacing the system board	104
5.2.18	Switching off the ID indicator	104
5.2.19	Specifying the chassis model	105
6	Power supply units	107
6.1	Basic information	108
6.1.1	Power supply unit configurations	108
6.1.2	Assembly rules	109

Contents

6.2	Standard power supply	110
6.2.1	Basic information	110
6.2.2	Replacing the standard power supply unit	110
6.2.2.1	Preliminary steps	110
6.2.2.2	Disconnecting power cables	111
6.2.2.3	Removing the defective standard power supply unit	112
6.2.2.4	Installing the new standard power supply unit	114
6.2.2.5	Connecting power cables	117
6.2.2.6	Concluding steps	117
6.3	Redundant power supply	118
6.3.1	Installing hot-plug power supply units	118
6.3.1.1	Preliminary steps	118
6.3.1.2	Removing the PSU dummy cover	118
6.3.1.3	Installing a hot-plug PSU	119
6.3.1.4	Concluding steps	119
6.3.2	Removing a hot-plug PSU	120
6.3.2.1	Preliminary steps	120
6.3.2.2	Removing a hot-plug PSU	121
6.3.2.3	Installing a PSU dummy cover	122
6.3.3	Replacing a hot-plug PSU	123
6.3.3.1	Preliminary steps	123
6.3.3.2	Removing the defective hot-plug PSU	123
6.3.3.3	Installing the new hot-plug PSU	124
6.3.3.4	Concluding steps	124
6.3.4	Replacing the power backplane	124
6.3.4.1	Preliminary steps	124
6.3.4.2	Removing the hot-plug PSUs	124
6.3.4.3	Replacing the defective power backplane	125
6.3.4.4	Concluding steps	126
6.4	Converting a standard power supply to a redundant power supply	127
6.4.1	Preliminary steps	127
6.4.2	Removing the standard power supply unit	127
6.4.3	Installing the hot-plug power supply units	128
6.4.4	Concluding steps	133
7	Hard disk drives / solid state drives	135
7.1	Basic information	136
7.2	2.5-inch HDD / SSD configurations	136

7.2.1	8x 2.5-inch HDD / SSD configuration	136
7.2.1.1	Mounting order	136
7.2.1.2	HDD / SSD naming scheme	137
7.2.2	16x 2.5-inch HDD / SSD configuration	138
7.2.2.1	Mounting order	138
7.2.2.2	HDD / SSD naming scheme	139
7.2.3	Installing 2.5-inch HDD / SSD modules	140
7.2.3.1	Preliminary steps	140
7.2.3.2	Removing a 2.5-inch HDD / SSD dummy module	140
7.2.3.3	Installing a 2.5-inch HDD / SSD module	141
7.2.3.4	Concluding steps	142
7.2.4	Removing 2.5-inch HDD / SSD modules	143
7.2.4.1	Preliminary steps	143
7.2.4.2	Removing a 2.5-inch HDD / SSD module	144
7.2.4.3	Installing a 2.5-inch HDD / SSD dummy module	145
7.2.4.4	Concluding steps	145
7.2.5	Replacing a 2.5-inch HDD / SSD module	146
7.2.5.1	Preliminary steps	146
7.2.5.2	Removing a 2.5-inch HDD / SSD module	147
7.2.5.3	Installing a 2.5-inch HDD / SSD module	147
7.2.5.4	Concluding steps	147
7.2.6	Replacing a 2.5-inch HDD SAS backplane	147
7.2.6.1	Preliminary steps	147
7.2.6.2	Removing the defective SAS backplane	148
7.2.6.3	Installing the new SAS backplane	149
7.2.6.4	Concluding steps	149
7.3	3.5-inch HDD configurations	150
7.3.1	4x 3.5-inch HDD configuration	150
7.3.1.1	Mounting order	150
7.3.1.2	HDD / SSD naming scheme	150
7.3.2	6x 3.5-inch HDD configuration	151
7.3.2.1	Mounting order	151
7.3.2.2	HDD / SSD naming scheme	152
7.3.3	8x 3.5-inch HDD configuration	152
7.3.3.1	Mounting order	152
7.3.3.2	HDD / SSD naming scheme	153
7.3.4	Installing 3.5-inch HDD modules	154
7.3.4.1	Preliminary steps	154
7.3.4.2	Removing a 3.5-inch HDD dummy module	154
7.3.4.3	Installing a 3.5-inch HDD module	155
7.3.4.4	Concluding steps	156

Contents

7.3.5	Removing 3.5-inch HDD modules	157
7.3.5.1	Preliminary steps	157
7.3.5.2	Removing a 3.5-inch HDD module	158
7.3.5.3	Installing a 3.5-inch HDD dummy module	159
7.3.5.4	Concluding steps	159
7.3.6	Replacing a 3.5-inch HDD module	160
7.3.6.1	Preliminary steps	160
7.3.6.2	Removing a 3.5-inch HDD module	161
7.3.6.3	Installing a 3.5-inch HDD module	161
7.3.6.4	Concluding steps	161
7.3.7	Replacing a 3.5-inch HDD SAS backplane	161
7.3.7.1	Preliminary steps	161
7.3.7.2	Removing the defective 3.5-inch HDD SAS backplane	162
7.3.7.3	Installing the new 3.5-inch HDD SAS backplane	164
7.3.7.4	Concluding steps	166
7.4	HDD extension boxes	167
7.4.1	HDD extension box variants	167
7.4.2	Installing an HDD extension box	170
7.4.2.1	Preliminary steps	170
7.4.2.2	Removing accessible drive dummy covers	171
7.4.2.3	Installing the HDD extension box	173
7.4.2.4	Concluding steps	176
7.4.3	Removing an HDD extension box	177
7.4.3.1	Preliminary steps	177
7.4.3.2	Removing the HDD extension box	177
7.4.3.3	Installing accessible drive dummy covers	179
7.4.3.4	Concluding steps	180
7.4.4	Replacing an HDD extension box	181
7.4.4.1	Preliminary steps	181
7.4.4.2	Removing the defective HDD extension box	181
7.4.4.3	Installing the new HDD extension box	181
7.4.4.4	Concluding steps	181
8	Fans	183
8.1	Basic information	183
8.2	System fans	186
8.2.1	Replacing the system fans	186
8.2.1.1	Preliminary steps	186
8.2.1.2	Removing the defective system fans	186

8.2.1.3	Installing the new system fans	186
8.2.1.4	Concluding steps	186
8.3	Rear fan	187
8.3.1	Installing the rear fan	187
8.3.1.1	Preliminary steps	187
8.3.1.2	Installing the rear fan	187
8.3.1.3	Concluding steps	190
8.3.2	Removing the rear fan	191
8.3.2.1	Preliminary steps	191
8.3.2.2	Removing the rear fan	191
8.3.2.3	Concluding steps	192
8.3.3	Replacing the rear fan	193
8.3.3.1	Preliminary steps	193
8.3.3.2	Removing the defectice rear fan	193
8.3.3.3	Installing the new rear fan	193
8.3.3.4	Concluding steps	193
9	Expansion cards and backup units	195
9.1	Basic information	196
9.2	Handling slot brackets	198
9.2.1	Installing a slot bracket	198
9.2.2	Removing a slot bracket	201
9.3	Handling SFP+ transceiver modules	202
9.3.1	Installing SFP+ transceiver modules	202
9.3.2	Removing an SFP+ transceiver module	205
9.4	Expansion cards in PCI slots	208
9.4.1	Installing expansion cards	208
9.4.1.1	Preliminary steps	208
9.4.1.2	Removing the PCI slot bracket	209
9.4.1.3	Installing an expansion card	209
9.4.1.4	Concluding steps	212
9.4.2	Removing expansion cards	212
9.4.2.1	Preliminary steps	212
9.4.2.2	Removing an expansion card	213
9.4.2.3	Installing a PCI slot bracket	215
9.4.2.4	Concluding steps	215
9.4.3	Replacing expansion cards	216
9.4.3.1	Preliminary steps	216

Contents

9.4.3.2	Removing an expansion card	216
9.4.3.3	Installing an expansion card	217
9.4.3.4	Connecting cables to the expansion card	217
9.4.3.5	Connecting a backup unit to the expansion card	217
9.4.3.6	Concluding steps	217
9.4.4	Replacing TFM	218
9.4.4.1	Preliminary steps	218
9.4.4.2	Removing the defective TFM	219
9.4.4.3	Installing the new TFM	219
9.4.4.4	Concluding steps	219
9.5	Backup Units	220
9.5.1	Basic information	220
9.5.2	Installing a BBU	221
9.5.2.1	Preliminary steps	221
9.5.2.2	Connecting the BBU cable to the BBU	221
9.5.2.3	Installing the BBU in the holder	222
9.5.2.4	Installing the BBU with the holder	223
9.5.2.5	Concluding steps	225
9.5.3	Installing an FBU	226
9.5.3.1	Preliminary steps	226
9.5.3.2	Installing TFM to the RAID controller (if applicable)	226
9.5.3.3	Installing the FBU in the holder	227
9.5.3.4	Connecting the FBU cable to the FBU	228
9.5.3.5	Installing the FBU with the holder	229
9.5.3.6	Concluding steps	230
9.5.4	Removing a BBU	230
9.5.4.1	Preliminary steps	231
9.5.4.2	Removing the BBU with the holder	231
9.5.4.3	Removing the BBU from the holder	232
9.5.4.4	Disconnecting the BBU cable from the BBU	232
9.5.4.5	Concluding steps	233
9.5.5	Removing an FBU	233
9.5.5.1	Preliminary steps	233
9.5.5.2	Removing the FBU with the holder	234
9.5.5.3	Disconnecting the FBU cable from the FBU	235
9.5.5.4	Removing the FBU from the holder	235
9.5.5.5	Concluding steps	236
9.5.6	Replacing a BBU	236
9.5.6.1	Preliminary steps	236
9.5.6.2	Removing the defective BBU	237
9.5.6.3	Installing the new BBU	237

9.5.6.4	Concluding steps	237
9.5.7	Replacing an FBU	238
9.5.7.1	Preliminary steps	238
9.5.7.2	Removing the defective FBU	238
9.5.7.3	Installing the new FBU	239
9.5.7.4	Concluding steps	239
10	Main memory	241
<hr/>		
10.1	Basic information	242
10.1.1	Memory sequence	243
10.1.1.1	Population rules	243
10.1.1.2	Independent Channel mode	244
10.1.1.3	Mirrored Channel mode	244
10.1.1.4	Performance mode	245
10.1.1.5	Rank Sparing mode	245
10.2	Installing memory modules	246
10.2.1	Preliminary steps	246
10.2.2	Installing a memory module	247
10.2.3	Concluding steps	247
10.3	Removing memory modules	248
10.3.1	Preliminary steps	248
10.3.2	Removing a memory module	248
10.3.3	Concluding steps	249
10.4	Replacing memory modules	249
10.4.1	Preliminary steps	249
10.4.2	Removing the defective memory module	250
10.4.3	Installing the new memory module	250
10.4.4	Concluding steps	250
11	Processors	251
<hr/>		
11.1	Basic information	252
11.1.1	Supported processors	252
11.1.2	Processor locations	252
11.2	Installing processors	253
11.2.1	Preliminary steps	253
11.2.2	Installing a processor	253
11.2.2.1	Removing the protective cover	254

Contents

11.2.2.2	Installing the new processor	255
11.2.3	Concluding steps	257
11.3	Removing processors	258
11.3.1	Preliminary steps	258
11.3.2	Removing a processor	258
11.3.2.1	Installing the protective cover	261
11.3.3	Concluding steps	262
11.4	Upgrading or replacing processors	263
11.4.1	Preliminary steps	263
11.4.2	Upgrading or replacing a processor	263
11.4.3	Concluding steps	264
11.5	Handling processor heat sinks	265
11.5.1	Preliminary steps	265
11.5.2	Installing processor heat sinks	266
11.5.2.1	Preparing the heat sink and processor	266
11.5.2.2	Installing the heat sink	267
11.5.3	Removing processor heat sinks	268
11.5.4	Replacing processor heat sinks	269
11.5.4.1	Removing the processor heat sink	269
11.5.4.2	Applying thermal paste	269
11.5.4.3	Installing the processor heat sink	269
11.5.5	Concluding steps	269
11.6	Applying thermal paste	270
12	Accessible drives and LSD	273
12.1	Basic information	274
12.2	Installing accessible drives	277
12.2.1	Preliminary steps	277
12.2.2	Removing accessible drive dummy covers	277
12.2.3	Installing mounting brackets to RDX and DAT72 backup drives	277
12.2.4	Installing an accessible drive	280
12.2.5	Concluding steps	283
12.3	Removing accessible drives	283
12.3.1	Preliminary steps	283
12.3.2	Removing an accessible drive	284
12.3.3	Installing accessible drive dummy covers	284
12.3.4	Concluding steps	285

12.4	Replacing accessible drives	285
12.4.1	Preliminary steps	285
12.4.2	Removing the defective accessible drive	286
12.4.3	Installing the new accessible drive	286
12.4.4	Concluding steps	286
12.5	Slimline ODD and LSD in Multibay box	287
12.5.1	Installing the slimline ODD or LSD	287
12.5.1.1	Preliminary steps	287
12.5.1.2	Installing the slimline ODD	287
12.5.1.3	Installing the LSD module	290
12.5.1.4	Removing accessible drive dummy covers	291
12.5.1.5	Installing the Multibay box	291
12.5.1.6	Concluding steps	293
12.5.2	Removing a slimline ODD or LSD	294
12.5.2.1	Preliminary steps	294
12.5.2.2	Removing the Multibay box	294
12.5.2.3	Removing the slimline ODD	295
12.5.2.4	Removing the LSD module	297
12.5.2.5	Installing the Multibay box	298
12.5.2.6	Concluding steps	298
12.5.3	Replacing a slimline ODD or LSD	299
12.5.3.1	Preliminary steps	299
12.5.3.2	Removing the defective slimline ODD	299
12.5.3.3	Removing the defective LSD module	299
12.5.3.4	Installing the new slimline ODD	299
12.5.3.5	Installing the new LSD module	300
12.5.3.6	Concluding steps	300
12.6	Slimline ODD and LSD in 2x 3.5-inch HDD extension box	300
12.6.1	Installing the slimline ODD or LSD	300
12.6.1.1	Preliminary steps	300
12.6.1.2	Installing the slimline ODD	301
12.6.1.3	Installing the LSD	304
12.6.1.4	Installing the 2x 3.5-inch HDD extension box	305
12.6.1.5	Cabling the slimline ODD and LSD	305
12.6.1.6	Concluding steps	306
12.6.2	Removing the slimline ODD or LSD	307
12.6.2.1	Preliminary steps	307
12.6.2.2	Removing the slimline ODD	308
12.6.2.3	Removing the LSD	310
12.6.2.4	Concluding steps	312
12.6.3	Replacing the slimline ODD or LSD	312

Contents

12.6.3.1	Preliminary steps	312
12.6.3.2	Removing the defective slimline ODD	312
12.6.3.3	Removing the defective LSD module	313
12.6.3.4	Installing the new slimline ODD	313
12.6.3.5	Installing the new LSD module	313
12.6.3.6	Concluding steps	313
12.7	Slimline ODD in 4x 3.5-inch HDD extension box	314
12.7.1	Installing the slimline ODD	314
12.7.1.1	Preliminary steps	314
12.7.1.2	Installing the slimline ODD	315
12.7.1.3	Installing the 4x 3.5-inch HDD extension box	319
12.7.1.4	Cabling the slimline ODD	319
12.7.1.5	Concluding steps	319
12.7.2	Removing the slimline ODD	320
12.7.2.1	Preliminary steps	320
12.7.2.2	Removing the slimline ODD	321
12.7.2.3	Concluding steps	323
12.7.3	Replacing the slimline ODD	323
12.7.3.1	Preliminary steps	323
12.7.3.2	Removing the defective slimline ODD	324
12.7.3.3	Installing the new slimline ODD	324
12.7.3.4	Concluding steps	324
13	Front panel and external connectors	325
13.1	Front panel module	326
13.1.1	Replacing the front panel module	326
13.1.1.1	Preliminary steps	326
13.1.1.2	Removing the front panel module	327
13.1.1.3	Replacing the front panel module cover	332
13.1.1.4	Installing the front panel module	334
13.1.1.5	Concluding steps	337
13.2	Front LAN connector	338
13.2.1	Installing the front LAN connector	338
13.2.1.1	Preliminary steps	338
13.2.1.2	Installing the front LAN connector	338
13.2.1.3	Concluding steps	341
13.2.1.4	Using the front management LAN connector	341
13.2.2	Removing the front LAN connector	342
13.2.2.1	Preliminary steps	342

13.2.2.2	Removing the front LAN connector	342
13.2.2.3	Concluding steps	343
13.2.3	Replacing the front LAN connector and board	344
13.2.3.1	Preliminary steps	344
13.2.3.2	Replacing the front LAN connector and board	344
13.2.3.3	Concluding steps	344
14	System board and components	347
14.1	Basic information	347
14.2	Replacing the CMOS battery	348
14.2.1	Preliminary steps	348
14.2.2	Removing the CMOS battery	349
14.2.3	Installing the CMOS battery	350
14.2.4	Concluding steps	350
14.3	USB Flash Module (UFM)	351
14.3.1	Installing the UFM	351
14.3.1.1	Preliminary steps	351
14.3.1.2	Installing the UFM	352
14.3.1.3	Concluding steps	353
14.3.1.4	Software configuration	353
14.3.2	Removing the UFM	354
14.3.2.1	Preliminary steps	354
14.3.2.2	Removing the UFM	354
14.3.2.3	Concluding steps	355
14.3.3	Replacing the UFM	355
14.3.3.1	Preliminary steps	355
14.3.3.2	Removing the defective UFM	356
14.3.3.3	Installing the new UFM	356
14.3.3.4	Concluding steps	358
14.3.3.5	Software configuration	358
14.4	Trusted Platform Module (TPM)	359
14.4.1	Installing the TPM	359
14.4.1.1	Preliminary steps	359
14.4.1.2	Installing the TPM	360
14.4.1.3	Concluding steps	363
14.4.2	Removing the TPM	363
14.4.2.1	Preliminary steps	364
14.4.2.2	Removing the TPM	365
14.4.2.3	Concluding steps	367

Contents

14.4.3	Replacing the TPM	367
14.4.3.1	Preliminary steps	368
14.4.3.2	Removing the defective TPM	368
14.4.3.3	Installing the new TPM	368
14.4.3.4	Concluding steps	368
14.5	SCU (SKU) key	369
14.5.1	Installing the SCU (SKU) key	369
14.5.1.1	Preliminary steps	369
14.5.1.2	Installing the SCU (SKU) key	369
14.5.1.3	Concluding steps	370
14.5.2	Removing the SCU (SKU) key	371
14.5.2.1	Preliminary steps	371
14.5.2.2	Removing the SCU (SKU) key	371
14.5.2.3	Concluding steps	372
14.5.3	Replacing the SCU (SKU) key	372
14.5.3.1	Preliminary steps	372
14.5.3.2	Replacing the SCU (SKU) key	372
14.5.3.3	Concluding steps	372
14.6	Replacing the system board	373
14.6.1	Preliminary steps	375
14.6.2	Removing the defective system board	375
14.6.3	Installing the new system board	379
14.6.4	Concluding steps	384
15	Converting a tower model to a rack model	387
15.1	Preliminary steps	387
15.2	Converting a tower model to a rack model	388
15.3	Concluding steps	400
16	Cabling	401
16.1	List of used cables	401
16.2	Cabling plans	403
16.3	Replacing the intrusion switch cable	407
16.3.1	Preliminary steps	407
16.3.2	Removing the defective intrusion switch cable	407
16.3.3	Installing the new intrusion switch cable	410

16.3.4	Concluding steps	412
17	Appendix	413
17.1	Mechanical overview	413
17.1.1	Server front	413
17.1.2	Server rear	415
17.1.3	Server interior	416
17.2	Connectors and indicators	417
17.2.1	Connectors and indicators on the system board	417
17.2.1.1	Onboard connectors	417
17.2.1.2	Onboard indicators and controls	419
17.2.1.3	I/O panel connectors	421
17.2.1.4	I/O panel indicators	422
17.2.1.5	PSU indicator (only hot-plug PSUs)	423
17.2.2	Connectors and indicators on the front panel	424
17.2.2.1	Front panel connectors	424
17.2.2.2	Front panel controls and indicators	424
17.3	Onboard settings	426
17.4	Minimum startup configuration	427

Contents

1 Introduction

This Upgrade and Maintenance Manual provides instructions for the following procedures:

- Upgrading the server configuration by adding optional hardware components
- Upgrading the server configuration by replacing existing hardware components with superior ones.
- Replacing defective hardware components

This manual focuses on on-site maintenance tasks. It is recommended to prepare each service assignment following remote diagnostics procedures, as described in the "ServerView Suite Local Service Concept (LSC)" manual (see section "[Documents you need at hand](#)" on page 32).









CAUTION!

The document at hand comprises procedures of a wide range of complexity. Check the profile of qualification for technicians before assigning tasks. Before you start, carefully read "[Classification of procedures](#)" on page 27.

1.1 Notational conventions

The following notational conventions are used in this manual:

<i>Text in italics</i>	indicates commands or menu items
fixed font	indicates system output
semi-bold fixed font	indicates text to be entered by the user
▶	describes activities that must be performed in the order shown
	indicates keys on the keyboard
 CAUTION!	Pay particular attention to texts marked with this symbol! Failure to observe this warning may endanger your life, destroy the system or lead to the loss of data.
	indicates additional information, notes and tips
  	indicates the procedure category in terms of complexity and qualification requirements, see "Classification of procedures" on page 27
	indicates the average task duration, see "Average task duration" on page 29

2 Before you start

Before you start any upgrade or maintenance task, please proceed as follows:

- ▶ Carefully read the safety instructions in chapter "[Important information](#)" on [page 35](#).
- ▶ Make sure that all necessary manuals are available. Refer to the documentation overview in section "[Documents you need at hand](#)" on [page 32](#). Print the PDF files if required.
- ▶ Make yourself familiar with the procedure categories introduced in section "[Classification of procedures](#)" on [page 27](#).
- ▶ Ensure that all required tools are available according to section "[Tools you need at hand](#)" on [page 30](#).

Installing optional components

The operating manual of your server (see section "[Documents you need at hand](#)" on [page 32](#)) gives an introduction to server features and provides an overview of available hardware options.

Use the Fujitsu ServerView Suite management software to prepare hardware expansions. ServerView Suite documentation is available online at <http://manuals.ts.fujitsu.com> (<http://jp.fujitsu.com/platform/server/primergy/system/> for the Japanese market) or from the ServerView Suite DVD 2 supplied with your PRIMERGY server. Please refer to the following ServerView Suite topics:

- Operation
- Virtualization
- Maintenance



For the latest information on hardware options, refer to your server's hardware configurator available online at the following address:

for the EMEA market:

http://ts.fujitsu.com/products/standard_servers/tower/primergy_tx200s7.html

http://ts.fujitsu.com/products/standard_servers/tower/primergy_tx150s8.html

for the Japanese market:

<http://jp.fujitsu.com/platform/server/primergy/system/>

Before you start

Please contact your local Fujitsu customer service partner for details on how to order expansion kits or spare parts. Use the Fujitsu Illustrated Spares Catalog to identify the required spare part and obtain technical data and order information. Illustrated Spares catalogs are available online at http://manuals.ts.fujitsu.com/illustrated_spares (EMEA market only).

Replacing a defective component

The global error indicators on the front and rear sides of the server as well as local diagnostic LEDs on the front panel report defective hardware components that need to be replaced. For further information on the controls and indicators of your server, refer to the operating manual of your server and section ["Connectors and indicators" on page 417](#).

If the system has been powered off in order to replace a non-hot plug unit, a system of PRIMERGY diagnostic indicators guides you to the defective component. The "Indicate CSS" button enables the indicator next to the defective component even if the server has been switched off and disconnected from the mains. For further information, please refer to sections ["Using diagnostics information" on page 47](#) and ["Connectors and indicators on the front panel" on page 424](#).

If the defective component is a customer replaceable unit included in the CSS concept (Customer Self Service, only available for EMEA market), the CSS indicators on the front and rear side of the server will light up.

It is recommended to prepare local maintenance tasks using remote diagnostics procedures, as described in the "ServerView Suite Local Service Concept (LSC)" manual.

2.1 Classification of procedures

The complexity of maintenance procedures varies significantly. Procedures have been assigned to one of three unit categories, indicating the level of difficulty and required qualification.

At the beginning of each procedure, the involved unit type is indicated by one of the symbols introduced in this section.



Please ask your local Fujitsu service center for more detailed information.

2.1.1 Customer Replaceable Units (CRU)



Customer Replaceable Units (CRU)

Customer Replaceable Units are intended for customer self service and may be installed or replaced as hot-plug components during operation.



Components that the customer is entitled to replace may differ according to the service form in his country.

Hot-plug components increase system availability and guarantee a high degree of data integrity and fail-safe performance. Procedures can be carried out without shutting down the server or going offline.

Components that are handled as Customer Replaceable Units

- Hot-plug power supply units
- Hot-plug fan modules
- Hot-plug HDD / SSD modules

Peripherals that are handled as Customer Replaceable Units

- Keyboard
- Mouse

2.1.2 Upgrade and Repair Units (URU)



Upgrade and Repair Units (URU)

Upgrade and Repair Units are non hot-plug components that can be ordered separately to be installed as options (*Upgrade Units*) or are available to the customer through customer self service (*Repair Units*).



Server management error messages and diagnostic indicators on the front panel and system board will report defective *Upgrade and Repair Units* as customer replaceable CSS components.

Upgrade and repair procedures involve shutting down and opening the server.



CAUTION!

The device may be seriously damaged or cause damage if it is opened without authorization or if repairs are attempted by unauthorized and untrained personnel.

Components that are handled as Upgrade Units

- Processors (upgrade kits)
- Optical disk drives
- Backup drives
- Expansion cards
- Battery backup units
- Memory modules
- USB Flash Module (UFM)

Components that are handled solely as Repair Units

- CMOS battery
- Non hot-plug fans
- Non hot-plug hard disk drives

2.1.3 Field Replaceable Units (FRU)



Field Replaceable Units (FRU)

Removing and installing *Field Replaceable Units* involves complex maintenance procedures on integral server components. Procedures will require shutting down, opening and disassembling the server.



CAUTION!

Maintenance procedures involving *Field Replaceable Units* must be performed exclusively by Fujitsu service personnel or technicians trained by Fujitsu. Please note that unauthorized interference with the system will void the warranty and exempt the manufacturer from all liability.

2.2 Average task duration



Hardware: 10 minutes

The average task duration including preliminary and concluding steps is indicated at the beginning of each procedure next to the procedure class.

Refer to [table 1 on page 29](#) for an overview of steps taken into account for calculating the average task duration:

Step	included	Explanation
Server shutdown	no	Shutdown time depends on hardware and software configuration and may vary significantly. Software tasks necessary before maintenance are described in section "Starting the maintenance task" on page 79 ".
Rack removal, disassembly	yes	Making the server available, removing the server from the rack (if applicable)

Table 1: Calculation of the average task duration

Before you start

Step	included	Explanation
Transport	no	Transporting the server to the service table (where required) depends on local customer conditions.
Maintenance procedures	yes	Maintenance procedures including preliminary and concluding software tasks
Transport	no	Returning the server to its installation site (where required) depends on local customer conditions.
Assembly, rack installation	yes	Reassembling the server, installing the server in the rack (if applicable)
Starting up	no	Booting time depends on hardware and software configuration and may vary significantly.

Table 1: Calculation of the average task duration

2.3 Tools you need at hand

When preparing the maintenance task, ensure that all required tools are available according to the overview below. You will find a list of required tools at the beginning of each procedure.



Screw driver / Bit insert	Screw	Usage	Type
Phillips PH2 / (+) No. 2 hexagonal cross SW5 / PZ2		Backup drives, optical disk drives, chassis	M3 x 4.5 mm (silver) C26192-Y10-C67
Phillips PH2 / (+) No. 2 hexagonal cross SW5 / PZ2		System board	M3 x 6 mm (silver) C26192-Y10-C68

Table 2: List of required tools and used screws

Screw driver / Bit insert	Screw	Usage	Type
Phillips PH2 / (+) No. 2 hexagonal cross SW5 / PZ2		Backup drives with UNC thread	UNC 6-32 x 4.76 mm (black) C26192-Y10-C75
Phillips PH0 / (+) No. 0		2.5-inch HDDs / SSDs	M3 x 3.5 mm Wafer head screw (silver) C26192-Y10- C102
TPM bit insert Dedicated TPM screw driver / TPM module fixing tool (for the Japanese market)		TPM screw One way head (black)	REM 3 x 15 mm (black) C26192-Y10- C176
Phillips PH1 / (+) No. 1		UFM nylon screw	M3 x 4.5 mm (white) A3C40109082
Phillips PH1 / (+) No. 1		TFM	M2.5 x 4 mm (silver) C26192-Y10- C103

Table 2: List of required tools and used screws

2.4 Documents you need at hand

Maintenance procedures may include references to additional documentation. When preparing the maintenance task, ensure that all required manuals are available according to the overview below.

-  – Ensure to store all printed manuals enclosed with your server in a save place for future reference.
- Unless stated otherwise, all manuals are available online at <http://manuals.ts.fujitsu.com> under *Industry standard servers* or from the ServerView Suite DVD 2 supplied with your PRIMERGY server.

For the Japanese market please use the following address:

<http://jp.fujitsu.com/platform/server/primergy/manual/>

Document	Description
"Quick Start Hardware - PRIMERGY TX150 S8 / TX200 S7" leaflet	Quick installation poster for initial operation, available only in printed form
"PRIMERGY ServerView Suite - Overview & Installation" DVD booklet	DVD booklet on initial software configuration included as a printed copy with the ServerView Suite
"Safety notes and regulations" manual "安全上のご注意" for the Japanese market	Important safety information, available from the ServerView Suite DVD 2, online, or as a printed copy
"PRIMERGY TX150 S8 Server Operating Manual"	available from the ServerView Suite DVD 2 or online
"PRIMERGY TX200 S7 Server Operating Manual"	available from the ServerView Suite DVD 2 or online
"D3079 BIOS Setup Utility for PRIMERGY TX150 S8 Reference Manual"	Information on configurable BIOS options and parameters, available from the ServerView Suite DVD 2 or online
"D3099 BIOS Setup Utility for PRIMERGY TX200 S7 Reference Manual"	Information on configurable BIOS options and parameters, available from the ServerView Suite DVD 2 or online

Table 3: Documentation you need at hand

Document	Description
System board label	Label inside the side / top server cover outlining connectors, indicators and jumpers
Software documentation	<ul style="list-style-type: none"> – "ServerView Suite Local Service Concept (LSC)" User Guide – "ServerView Operations Manager - Server Management" User Guide
Illustrated Spares catalog	Spare parts identification and information system (EMEA market only), available for online use or download (Windows OS) at http://manuals.ts.fujitsu.com/illustrated_spares or from the CSS component view of the ServerView Operations Manager
Glossary	available from the ServerView Suite DVD 2 or online
"Warranty" manual "保証書" for the Japanese market	Important information on warranty regulations, recycling and service , available from the ServerView Suite DVD 2, online, or as a printed copy
"Returning used devices" manual	Recycling and contact information, available from the ServerView Suite DVD 2, online, or as a printed copy
"Service Desk" leaflet "サポート & サービス" for the Japanese market	

Table 3: Documentation you need at hand

Before you start

Document	Description
Additional documentation	<ul style="list-style-type: none"><li data-bbox="468 225 954 312">– "iRMC S2 / S3" User Guide available from the ServerView Suite DVD 2 or online<li data-bbox="468 331 954 453">– RAID documentation, available online at http://manuals.ts.fujitsu.com under <i>Industry standard servers - Expansion Cards - Storage Adapters</i>, e.g.:<ul style="list-style-type: none"><li data-bbox="542 472 954 528">– "Integrated RAID for SAS" User Guide<li data-bbox="542 533 954 588">– "LSI MegaRAID - SAS Software" User Guide<li data-bbox="542 593 954 649">– "Modular RAID Controller / Modular SAS HBA" Installation Guide <p data-bbox="505 671 954 727">For the Japanese market please use the following address: http://jp.fujitsu.com/platform/server/primergy/manual/</p> <ul style="list-style-type: none"><li data-bbox="468 812 738 836">– Rack documentation
Third party documentation	<ul style="list-style-type: none"><li data-bbox="468 855 954 911">– Operating system documentation, online help<li data-bbox="468 930 808 954">– Peripherals documentation

Table 3: Documentation you need at hand

3 Important information



CAUTION!

Before installing and starting up a device, please observe the safety instructions listed in the following section. This will help you to avoid making serious errors that could impair your health, damage the device and endanger the data base.



Keep this manual and the other documentation (such as the operating manual and documentation DVD) close to the device. All documentation must be included if the equipment is passed on to a third party.

3.1 Safety instructions



The following safety instructions are also provided in the manual "Safety Notes and Regulations" or "安全上のご注意".

This device meets the relevant safety regulations for IT equipment. If you have any questions about whether you can install the server in the intended environment, please contact your sales outlet or our customer service team.

- The actions described in this manual shall be performed by technical specialists. A technical specialist is a person who is trained to install the server including hardware and software.
- Repairs to the device that do not relate to CSS failures shall be performed by service personnel. Please note that unauthorized interference with the system will void the warranty and exempt the manufacturer from all liability.
- Any failure to observe the guidelines in this manual, and any improper repairs could expose the user to risks (electric shock, energy hazards, fire hazards) or damage the equipment.
- Before installing/removing internal options to/from the server, turn off the server, all peripheral devices, and any other connected devices. Also unplug all power cords from the power outlet. Failure to do so can cause electric shock or damage.

Important information

Before starting up

- During installation and before operating the device, observe the instructions on environmental conditions for your device.
- If the device is brought in from a cold environment, condensation may form both inside and on the outside of the device.

Wait until the device has acclimatized to room temperature and is absolutely dry before starting it up. Material damage may be caused to the device if this requirement is not observed.

- Transport the device only in the original packaging or in packaging that protects it from knocks and jolts.
For the Japanese market, transporting the device in its original packaging does not apply.

Installation and operation

- This unit should not be operated in ambient temperatures above 35 °C.
- If the unit is integrated into an installation that draws power from an industrial power supply network with an IEC309 connector, the power supply's fuse protection must comply with the requirements for non-industrial power supply networks for type A connectors.
- The unit automatically adjusts itself to a mains voltage in a range of 100 VAC to 240 VAC. Ensure that the local mains voltage lies within these limits.
- This device must only be connected to properly grounded power outlets or connected to the grounded rack internal power distribution system with tested and approved power cords.
- Ensure that the device is connected to a properly grounded power outlet close to the device.
- Ensure that the power sockets on the device and the properly grounded power outlets are easily accessible.
- The On/Off button or the main power switch (if present) does not isolate the device from the mains power supply. In case of repair or servicing disconnect the device completely from the mains power supply, unplug all power plugs from the properly grounded power outlets.

- Always connect the server and the attached peripherals to the same power circuit. Otherwise you run the risk of losing data if, for example, the server is still running but a peripheral device (e.g. memory subsystem) fails during a power outage.
- Data cables must be adequately shielded.
- Ethernet cabling has to comply with EN 50173 and EN 50174-1/2 standards or ISO/IEC 11801 standard respectively. The minimum requirement is a Category 5 shielded cable for 10/100 Ethernet, or a Category 5e cable for Gigabit Ethernet.
- Route the cables in such a way that they do not create a potential hazard (make sure no-one can trip over them) and that they cannot be damaged. When connecting the server, refer to the relevant instructions in this manual.
- Never connect or disconnect data transmission lines during a storm (risk of lightning hazard).
- Make sure that no objects (e.g. jewelry, paperclips etc.) or liquids can get inside the server (risk of electric shock, short circuit).
- In emergencies (e.g. damaged casing, controls or cables, penetration of liquids or foreign bodies), contact the system administrator or your customer service team. Only disconnect the system from the mains power supply if there is no risk of harming yourself.
- Proper operation of the system (in accordance with IEC 60950-1 resp. EN 60950-1) is only ensured if the casing is completely assembled and the rear covers for the installation slots have been fitted (electric shock, cooling, fire protection, interference suppression).
- Only install system expansions that satisfy the requirements and rules governing safety and electromagnetic compatibility and those relating to telecommunication terminals. If you install other expansions, they may damage the system or violate the safety regulations. Information on which system expansions are approved for installation can be obtained from our customer service center or your sales outlet.
- The components marked with a warning notice (e.g. lightning symbol) may only be opened, removed or exchanged by authorized, qualified personnel. Exception: CSS components can be replaced.
- The warranty is void if the server is damaged during installation or replacement of system expansions.

Important information

- Only set screen resolutions and refresh rates that are specified in the operating manual for the monitor. Otherwise, you may damage your monitor. If you are in any doubt, contact your sales outlet or customer service center.
- Before installing/removing internal options to/from the server, turn off the server, all peripheral devices, and any other connected devices. Also unplug all power cords from the outlet. Failure to do so can cause electric shock.
- Do not damage or modify internal cables or devices. Doing so may cause a device failure, fire, or electric shock and will void the warranty and exempt the manufacturer from all liability.
- Devices inside the server remain hot after shutdown. Wait for a while after shutdown before installing or removing internal options.
- The circuit boards and soldered parts of internal options are exposed and can be damaged by static electricity. To ensure reliable protection, if you are wearing an earthing band on your wrist when working with this type of module, connect it to an unpainted, non-conducting metal part of the system.
- Do not touch the circuitry on boards or soldered parts. Hold the metallic areas or the edges of the circuit boards.
- Install the screw removed during installation/detaching internal options in former device/position. To use a screw of the different kind can cause a breakdown of equipment.
- The installation indicated on this document is sometimes changed to the kind of possible options without notice.

Batteries

- Incorrect replacement of batteries may lead to a risk of explosion. The batteries may only be replaced with identical batteries or with a type recommended by the manufacturer.
- Do not throw batteries into the trash can.
- Batteries must be disposed of in accordance with local regulations concerning special waste.
- Make sure that you insert the battery the right way round.
- The battery used in this device may present a fire or chemical burn hazard if mistreated. Do not disassemble, heat about 100 °C (212F), or incinerate the battery.

- All batteries containing pollutants are marked with a symbol (a crossed-out garbage can). In addition, the marking is provided with the chemical symbol of the heavy metal decisive for the classification as a pollutant:

Cd Cadmium

Hg Mercury

Pb Lead

Working with optical disk drives and media

When working with optical disk drives, these instructions must be followed.



CAUTION!

- Only use CDs/DVDs/BDs that are in perfect condition, in order to prevent data loss, equipment damage and injury.
- Check each CD/DVD/BD for damage, cracks, breakages etc. before inserting it in the drive.

Note that any additional labels applied may change the mechanical properties of a CD/DVD/BD and cause imbalance and vibrations.

Damaged and imbalanced CDs/DVDs/BDs can break at high drive speeds (data loss).

Under certain circumstances, sharp CD/DVD/BD fragments can pierce the cover of the optical disk drive (equipment damage) and can fly out of the device (danger of injury, particularly to uncovered body parts such as the face or neck).

- High humidity and airborne dust levels are to be avoided. Electric shocks and/or server failures may be caused by liquids such as water, or metallic items, such as paper clips, entering a drive.
- Shocks and vibrations are also to be avoided.
- Do not insert any objects other than the specified CDs/DVDs/BDs.
- Do not pull on, press hard, or otherwise handle the CD/DVD/BD tray roughly.
- Do not disassemble the optical disk drive.
- Before use, clean the optical disk tray using a soft, dry cloth.

Important information

- As a precaution, remove disks from the optical disk drive when the drive is not to be used for a long time. Keep the optical disk tray closed to prevent foreign matter, such as dust, from entering the optical disk drive.
- Hold CDs/DVDs/BDs by their edges to avoid contact with the disk surface.
- Do not contaminate the CD/DVD/BD surface with fingerprints, oil, dust, etc. If dirty, clean with a soft, dry cloth, wiping from the center to the edge. Do not use benzene, thinners, water, record sprays, antistatic agents, or silicone-impregnated cloth.
- Be careful not to damage the CD/DVD/BD surface.
- Keep the CDs/DVDs/BDs away from heat sources.
- Do not bend or place heavy objects on CDs/DVDs/BDs.
- Do not write with ballpoint pen or pencil on the label (printed) side.
- When a CD/DVD/BD is moved from a cold place to a warm place, moisture condensation on the CD/DVD/BD surface can cause data read errors. In this case, wipe the CD/DVD/BD with a soft, dry cloth then let it air dry. Do not dry the CD/DVD/BD using devices such as a hair dryer.
- To avoid dust, damage, and deformation, keep the CD/DVD/BD in its case whenever it is not in use.
- Do not store CDs/DVDs/BDs at high temperatures. Areas exposed to prolonged direct sunlight or near heating appliances are to be avoided.



You can prevent damage from the optical disk drive and the CDs/DVDs/BDs, as well as premature wear of the disks, by observing the following suggestions:

- Only insert disks in the drive when needed and remove them after use.
- Store the disks in suitable sleeves.
- Protect the disks from exposure to heat and direct sunlight.

Laser information

The optical disk drive complies with IEC 60825-1 laser class 1.



CAUTION!

The optical disk drive contains a light-emitting diode (LED), which under certain circumstances produces a laser beam stronger than laser class 1. Looking directly at this beam is dangerous.

Never remove parts of the optical disk drive casing!

Modules with Electrostatic-Sensitive Devices

Modules with electrostatic-sensitive devices are identified by the following sticker:

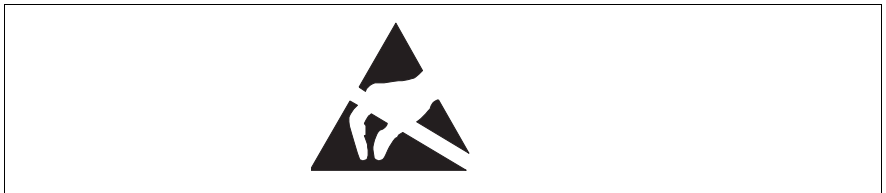

Figure 1: ESD label

When you handle components fitted with ESDs, you must always observe the following points:

- Switch off the system and remove the power plugs from the power outlets before installing or removing components with ESDs.
- The circuit boards and soldered parts of internal options are exposed and can be damaged by static electricity. To ensure reliable protection, you must wear an earthing band on your wrist when working with this type of module and connect it to an unpainted, non-conducting metal part of the system.
- Any devices or tools that are used must be free of electrostatic charge.
- Wear a suitable grounding cable that connects you to the external chassis of the system unit.
- Always hold components with ESDs at the edges or at the points marked green (touch points).
- Do not touch any connectors or conduction paths on an ESD.
- Place all the components on a pad which is free of electrostatic charge.



For a detailed description of how to handle ESD components, see the relevant European or international standards (EN 61340-5-1, ANSI/ESD S20.20).

Transporting the server

- Only transport the server in its original packaging or in packaging that protects it from impacts and jolts.
For the Japanese market, transporting the device in its original packaging does not apply.
- Do not unpack the server until it is at its installation location.
- If you need to lift or transport the server, ask other people to help you.
Because the PRIMERGY TX150 S8 / TX200 S7 is large and heavy, at least two people are needed.
- Never lift or carry the device by the handles on the front panel.

Notes on installing the server in the rack

- **For safety reasons, at least two people are required to install the server in the rack because of its weight and size.**
(For the Japanese market, please refer to "安全上のご注意".)
- Never lift the server into the rack using the handles on the front panel.
- When connecting and disconnecting cables, observe the relevant instructions in the "Important Information" chapter of the technical manual for the corresponding rack. The technical manual is supplied with the corresponding rack.
- When installing the rack, make sure that the anti-tilt protection is correctly fitted.
- For safety reasons, no more than one unit may be removed from the rack at any one time during installation and maintenance work.
- If several units are simultaneously removed from the rack, there is a risk that the rack could tip over.
- The rack must be connected to the power supply by an authorized specialist (electrician).
- If the server is integrated into an installation that draws power from an industrial power supply network with an IEC309 type connector, the power supply's fuse protection must comply with the requirements for non-industrial power supply networks for the type A connector.

3.2 CE conformity



The system complies with the requirements of the EC directives 2004/108/EC regarding "Electromagnetic Compatibility" and 2006/95/EC "Low Voltage Directive". This is indicated by the CE marking (CE = Communauté Européenne).

3.3 FCC Class A Compliance Statement

If there is an FCC statement on the device, it applies to the products covered in this manual, unless otherwise specified herein. The statement for other products will appear in the accompanying documentation.

NOTE:

This equipment has been tested and found to comply with the limits for a "Class A" digital device, pursuant to Part 15 of the FCC rules and meets all requirements of the Canadian Interference-Causing Equipment Standard ICES-003 for digital apparatus. These limits are designed to provide reasonable protection against harmful interference in a residential installation. This equipment generates, uses and can radiate radio frequency energy and, if not installed and used in strict accordance with the instructions, may cause harmful interference to radio communications. However, there is no warranty that interference will not occur in a particular installation. If this equipment does cause harmful interference to radio or television reception, which can be determined by turning the equipment off and on, the user is encouraged to try to correct the interference by one or more of the following measures:

- Reorient or relocate the receiving antenna.
- Increase the separation between equipment and the receiver.
- Connect the equipment into an outlet on a circuit different from that to which the receiver is connected.
- Consult the dealer or an experienced radio/TV technician for help.

Fujitsu is not responsible for any radio or television interference caused by unauthorized modifications of this equipment or the substitution or attachment of connecting cables and equipment other than those specified by Fujitsu. The correction of interferences caused by such unauthorized modification, substitution or attachment will be the responsibility of the user.

Important information

The use of shielded I/O cables is required when connecting this equipment to any and all optional peripheral or host devices. Failure to do so may violate FCC and ICES rules.

WARNING:

This is a class A product. In a domestic environment this product may cause radio interference in which case the user may be required to take adequate measures.

3.4 Environmental protection

Environmentally-friendly product design and development

This product has been designed in accordance with the Fujitsu standard for "environmentally friendly product design and development". This means that key factors such as durability, selection and labeling of materials, emissions, packaging, ease of dismantling and recycling have been taken into account.

This saves resources and thus reduces the harm done to the environment. Further information can be found at:

- http://ts.fujitsu.com/products/standard_servers/index.html (for the EMEA market)
- <http://jp.fujitsu.com/platform/server/primergy/concept/> (for the Japanese market)

Energy-saving information

Devices that do not need to be constantly switched on should be switched off until they are needed as well as during long breaks and after completion of work.

Packaging information

This packaging information doesn't apply to the Japanese market.

Do not throw away the packaging. You may need it later for transporting the system. If possible, the equipment should only be transported in its original packaging.

Information on handling consumables

Please dispose of printer consumables and batteries in accordance with the applicable national regulations.

In accordance with EU directives, batteries must not be disposed of with unsorted domestic waste. They can be returned free of charge to the manufacturer, dealer or an authorized agent for recycling or disposal.

All batteries containing pollutants are marked with a symbol (a crossed-out garbage can). They are also marked with the chemical symbol for the heavy metal that causes them to be categorized as containing pollutants:

Cd Cadmium

Hg Mercury

Pb Lead

Labels on plastic casing parts

Please avoid sticking your own labels on plastic parts wherever possible, since this makes it difficult to recycle them.

Returns, recycling and disposal

Please handle returns, recycling and disposal in accordance with local regulations.



The device must not be disposed of with domestic waste. This device is labeled in compliance with European directive 2002/96/EC on waste electrical and electronic equipment (WEEE).

This directive sets the framework for returning and recycling used equipment and is valid across the EU. When returning your used device, please use the return and collection systems available to you. Further information can be found at

<http://ts.fujitsu.com/recycling>.

Details regarding the return and recycling of devices and consumables within Europe can also be found in the "Returning used devices" manual, via your local Fujitsu branch or from our recycling center in Paderborn:

Fujitsu Technology Solutions

Recycling Center

D-33106 Paderborn

Tel. +49 5251 525 1410

Fax +49 5251 525 32 1410

4 Basic hardware procedures

4.1 Using diagnostics information

Use the Fujitsu ServerView Suite management software to plan the upgrade or replacement of hardware components. Please refer to the following ServerView Suite topics:

- Operation
- Maintenance

It is recommended to prepare local maintenance tasks using remote diagnostics procedures, as described in the "ServerView Suite Local Service Concept (LSC)" manual.

Please contact your local Fujitsu customer service partner for details on the service concept and on how to order expansion kits or spare parts. Use the Fujitsu Illustrated Spares Catalog to identify the required spare part and obtain technical data and order information. Illustrated Spares catalogs are available online at http://manuals.ts.fujitsu.com/illustrated_spares (EMEA market only).

Perform the following diagnostics procedures to identify defective servers and components.

4.1.1 Locating the defective server

When working in a datacenter environment, switch on the ID indicator on the front and rear connector panels of the server for easy identification.

- ▶ Press the ID button on the front panel or use the ServerView Operation Manager user interface to switch on the system ID indicator LEDs.



For further information, refer to the "ServerView Suite Local Service Concept (LSC)" manual.

- ▶ When using ServerView Operations Manager to toggle the ID indicator, choose *Single System View* and press the *Locate* button.
- ▶ Remember to switch off the ID indicator after the maintenance task has been concluded successfully.

4.1.2 Determining the error class

The Local Service Concept (LSC) allows you to identify defective server components. Failure events are assigned to one of two error classes:

- **Global Error** events that need to be resolved by maintenance personnel
- **Customer Self Service (CSS)** error events that may be resolved by operating personnel

Global Error and CSS LEDs indicate, if the defective component is a customer replaceable unit or if maintenance personnel needs to be dispatched to replace the part.



The indicators also light up in standby mode and after a server restart due to a power failure.

4.1.2.1 Global Error indicator

- ▶ Check the Global Error indicator on the front or connector panel of the server
- ▶ For further diagnostics, proceed as follows:

- Hardware errors:

Check the System Event Log (SEL) as described in section "[Viewing the SEL](#)" on page 97.

- Software / agent related errors:

Check the ServerView System Monitor, available on Windows or Linux based servers with ServerView agents installed.



For further information, please refer to the "ServerView System Monitor" user guide.

4.1.2.2 Customer Self Service (CSS) indicator

- ▶ Check the CSS indicator on the front panel or connector panel of the server:

4.1.3 Locating the defective component

After determining the error class by the CSS or Global Error indicators (see section ["Determining the error class" on page 48](#)) local diagnostic indicators on the front panel and system board allow you to identify the defective component.



For further information, refer to the "ServerView Suite Local Service Concept (LSC)" manual.

4.1.3.1 Local diagnostic indicators on the front

- ▶ Check the CSS indicator on the front and connector panels of the server:



In addition to local diagnostic indicators, CSS or Global Error LEDs indicate, if the defective component is a customer or field replaceable unit (see section ["Determining the error class" on page 48](#)).

4.1.3.2 Local diagnostic indicators on the system board

Using the Indicate CSS button

- ▶ Shut down and power off the server.
- ▶ Disconnect the AC power cord from the system.



It is mandatory to disconnect power cords in order to use the Indicate CSS functionality.

- ▶ Press the Indicate CSS button to highlight defective components (see section ["Onboard indicators and controls" on page 419](#)).



In addition to local diagnostic indicators, CSS or Global Error LEDs indicate, if the defective component is a customer replaceable unit or if a service technician needs to be dispatched to replace the part (see section ["Determining the error class" on page 48](#)).

If the system has been powered off to replace a non hot-plug unit, a system of PRIMERGY diagnostics indicators guides you to the faulty component.

4.2 Shutting down the server



CAUTION!

For further safety information, please refer to chapter ["Important information" on page 35](#).



This step is only required when upgrading or replacing non-hot plug components.

- ▶ Inform the system administrator that the server will be shut down and put offline.
- ▶ Terminate all applications.
- ▶ Perform the required procedures described in the preliminary steps of each upgrade or maintenance task.
- ▶ Shut down the server.



If the system is running an ACPI-compliant operating system, pressing the On / Off button will perform a graceful shutdown.

- ▶ Switch on the ID indicator on the front and rear connector panels of the server as described in section ["Locating the defective server" on page 47](#).

4.3 Disconnecting the server from the mains

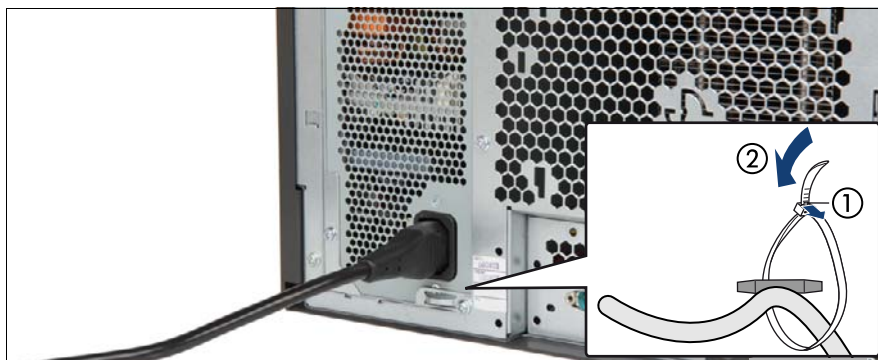

Figure 2: Removing the power cord from the cable tie

- ▶ Pull out on the locking lever on the cable tie (1) and loosen the loop (2).
- ▶ Disconnect the power cord from the PSU and remove it from the cable tie.

4.4 Getting access to the component



CAUTION!

- Before removing or installing covers, turn off the server and all peripheral devices. Also unplug all power cables from the outlet. Failure to do so can cause electric shock.
- In order to comply with applicable EMC regulations (regulations on electromagnetic compatibility) and satisfy cooling requirements, the server must not run while the top / side cover is removed.
- For further safety information, please refer to chapter ["Important information" on page 35](#).

4.4.1 Rack model

4.4.1.1 Extending the server out of the rack



CAUTION!

- Use the anti-tilt plate to prevent the rack from tipping when installing the rack. Pulling the server out of the rack without having installed the anti-tilt plate may cause the rack to tip over.
- Be careful not to pinch fingers or clothes when sliding out the server or pushing it back. Failure to do so may cause injury.
- For further safety information, please refer to chapter ["Important information" on page 35](#).

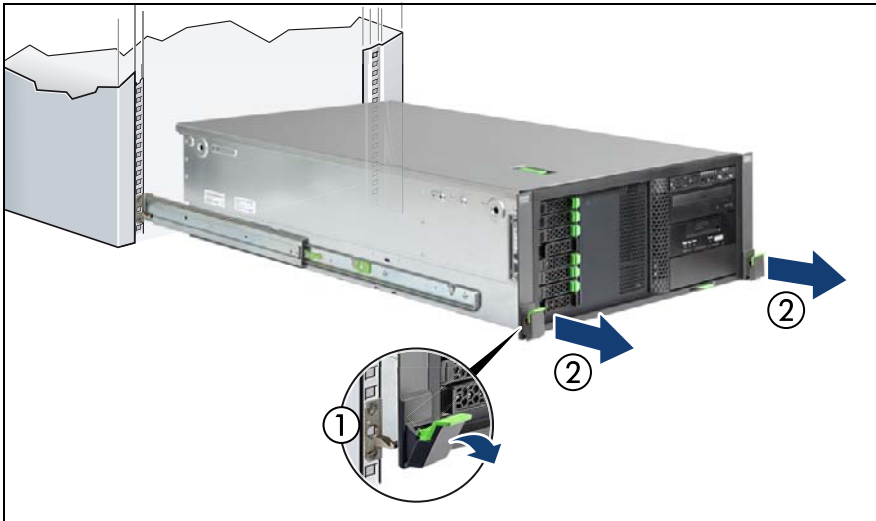

Figure 3: Extending the server out of the rack

- ▶ Remove all remaining external cables from the rear connector panel and expansion cards (see section ["Connectors and indicators" on page 417](#)).
- ▶ If you are not using a cable mounting arm (CMA kit), ensure that the rear cables are long enough not to be strained or damaged when extending the server out of the rack.
- ▶ Fold down the two quick release levers (1) and pull the server out of the rack until it locks in place (2).



CAUTION!

Do not use the extended server as a surface on which to put things or as a work surface, and strictly avoid leaning on or against it.

4.4.1.2 Removing the server from the rack



In most cases maintenance tasks can be performed while the server is extended from the rack. However, depending on accessibility or security guidelines, it may make sense to completely remove the server from the rack cabinet for maintenance purposes.



CAUTION!

At least two people are needed to lift the server out of the rack cabinet. (For the Japanese market, please refer to "安全上のご注意".)



For configurations below 32 kg:

At least two people are needed to lift the server out of the rack cabinet.



For configurations below 55 kg:

At least three people are needed to lift the server out of the rack cabinet.

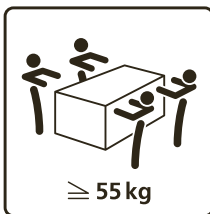

For configurations above 55 kg:

At least four people are needed to lift the server out of the rack cabinet.

Additionally, a lifter is required in the following cases:

- The server weighs more than 50 kg.
- The server weighs more than 21 kg and is installed above the height of 25 U.

When using a lifter, this removal procedure needs to be carried out by maintenance personnel.

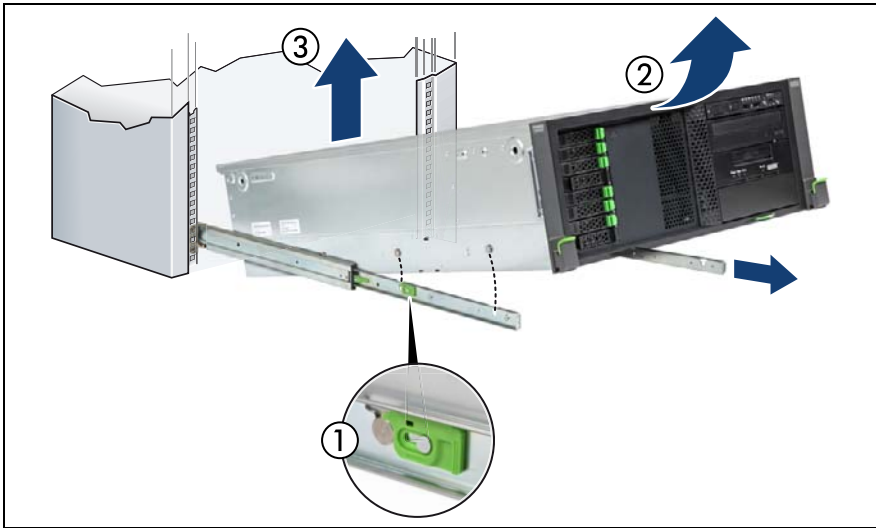

Figure 4: Removing the server from the rack

- ▶ Release the locking bars on both rails (1).
- ▶ Lift up the front of the server as shown so that the front and middle rack mounting bolts are disengaged from the mounting points on the telescopic rails (2).
- ▶ Lift the server out of the rear mounting points (3) and place it on an even surface.

4.4.1.3 Removing the top cover

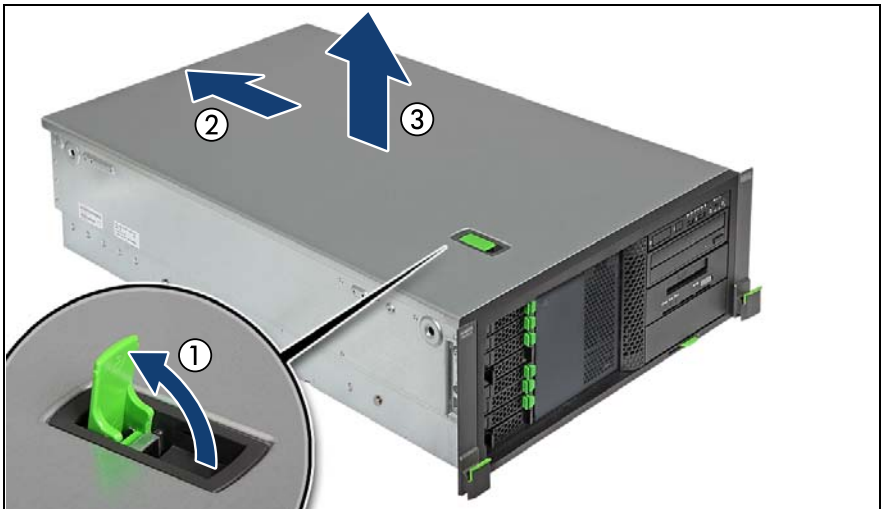

Figure 5: Removing the top cover (rack server)

- ▶ Open the locking lever (1). This will slide the top cover back disengaging the locking mechanism (2).
- ▶ Remove the top cover (3).

4.4.1.4 Removing the rack front cover

- i** You remove the rack front cover when installing/removing accessible drives or HDD extension boxes.



Figure 6: Removing the ID card (rack server)

- ▶ Remove the ID card from the server.

- i** It may be necessary to pull out on the ID card rather firmly. However, do not apply excessive force.



Figure 7: Removing the rack front cover (A)

- ▶ Remove two screws (see circles) from the side brackets on either side.

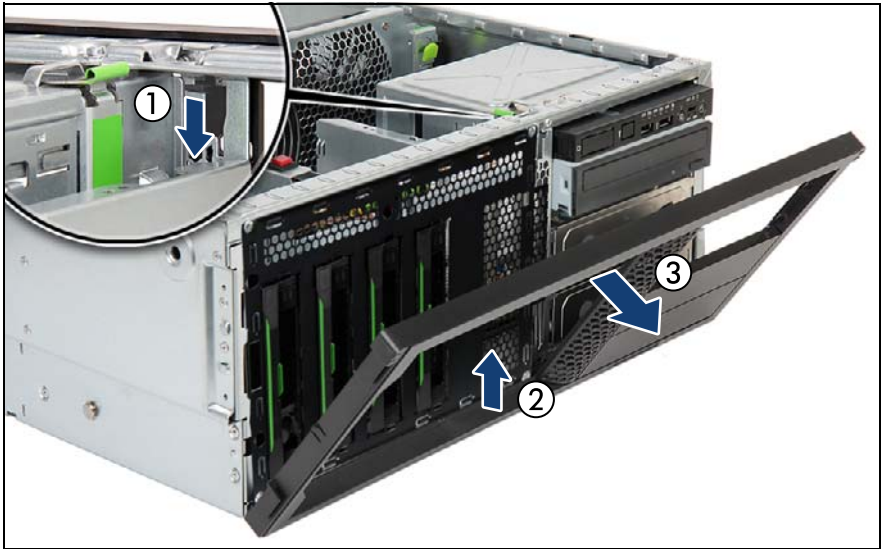

Figure 8: Removing the rack front cover (B)

- ▶ Press down on the upper locking latch (1) while slightly folding out the rack front cover.
- ▶ Press up on the rack front cover to disengage the lower locking latch (2).
- ▶ Carefully fold open and remove the rack front cover (3).

4.4.2 Tower model

4.4.2.1 Unlocking the server

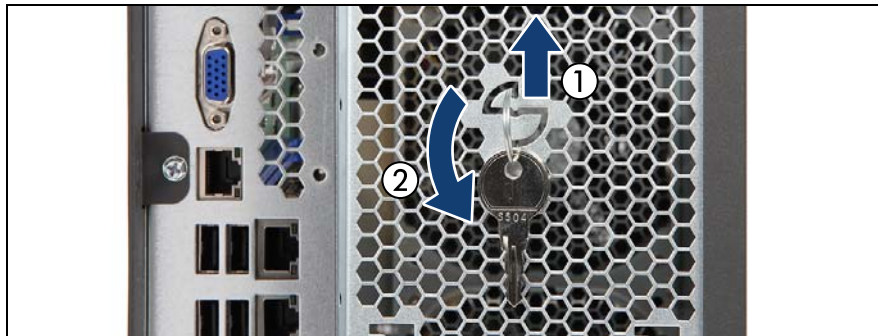

Figure 9: Removing the key

- ▶ Lift the key ring to unlatch it (1).
- ▶ Turn the key ring counter-clockwise by 90 degrees (2).
- ▶ Remove the key from the server rear.



Figure 10: Unlocking the server

- ▶ Insert the key into the lock on the server front.
- ▶ Turn the key clockwise to unlock the front and side covers (1).
- ▶ Remove the key from the server front (2) and set aside for later use.

4.4.2.2 Removing the side cover



Figure 11: Removing the side cover (tower server)

- ▶ Open the locking lever (1). This will slide the side cover back disengaging the locking mechanism (2).
- ▶ Remove the side cover (3).

4.4.2.3 Removing accessible drive and HDD bay covers

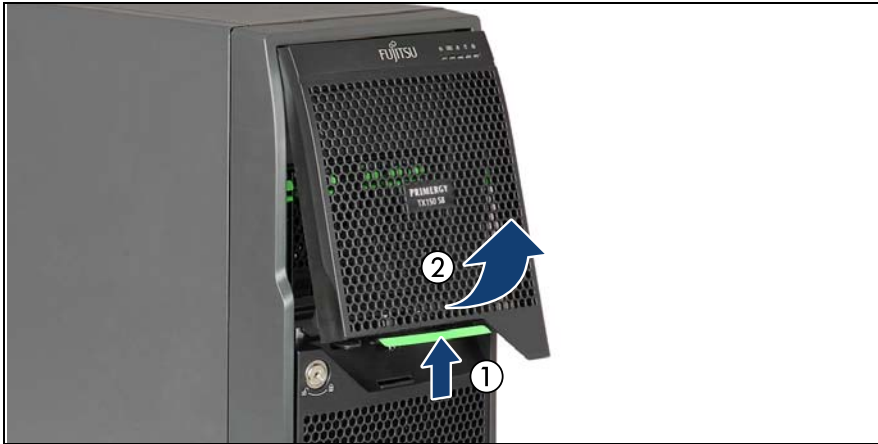

Figure 12: Removing the accessible drive bay cover

- ▶ Press up on the locking latch (1) and fold out the accessible drive bay cover (2).
- ▶ Remove the accessible drive bay cover from the front cover.



Figure 13: Removing the HDD bay cover

- ▶ Pull out on the handle on the upper edge of the HDD bay cover.
- ▶ Fold out and remove the HDD bay cover from the front cover.

4.4.2.4 Removing the front cover



You remove the front cover when:

- installing/removing accessible drives or HDD extension boxes
- converting a tower model to a rack model



Figure 14: Removing the ID card (tower server)

- ▶ Remove the ID card from the server.



It may be necessary to pull out on the ID card rather firmly. However, do not apply excessive force.



Figure 15: Removing the front cover (tower server)

- ▶ Pinch the locking clips to disengage the front cover (1) while slightly pulling out.
- ▶ Carefully fold out the bottom end of the front cover (2).
- ▶ Unhook and remove the front cover (3).

4.4.3 Removing the system air duct

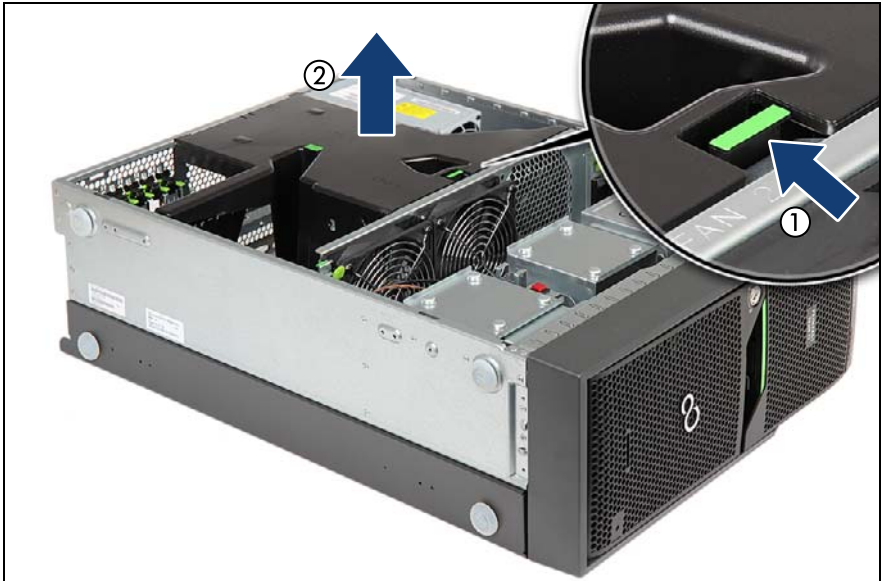

Figure 16: Removing the system air duct

- ▶ Press in on the green locking latch to disengage the system air duct (1).
- ▶ Hold the system air duct by the two green touch points and lift it out of the chassis (2).

4.5 Reassembling



CAUTION!

- Before attaching the covers, make sure no unnecessary parts or tools are left inside the server.
- In order to comply with applicable EMC regulations (regulations on electromagnetic compatibility) and satisfy cooling requirements, the server must not run while the top / side cover is removed.
- For further safety information, please refer to chapter "[Important information](#)" on page 35.

4.5.1 Installing the system air duct

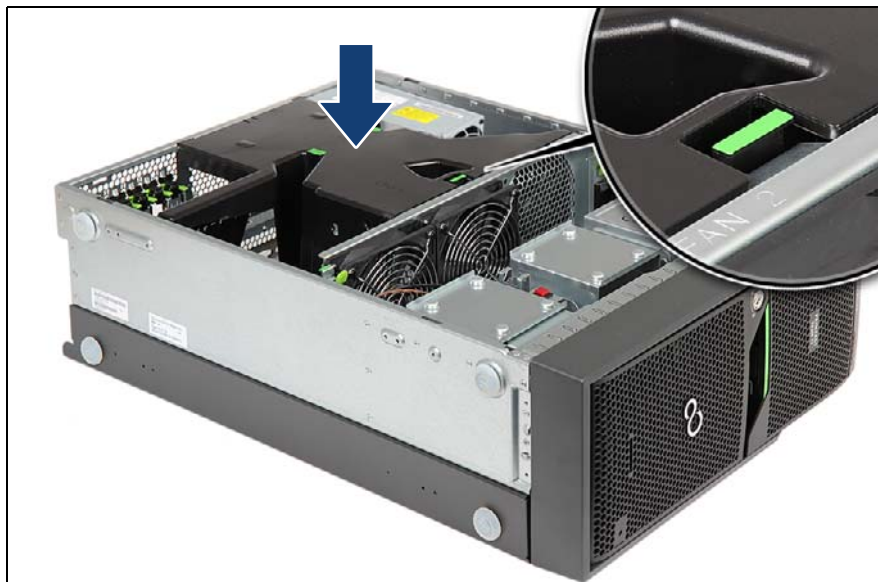

Figure 17: Installing the system air duct

- ▶ Hold the system air duct by the two green touch points and lower it into the chassis until the green locking latch clicks in (see close-up).

4.5.2 Rack model

4.5.2.1 Installing the rack front cover

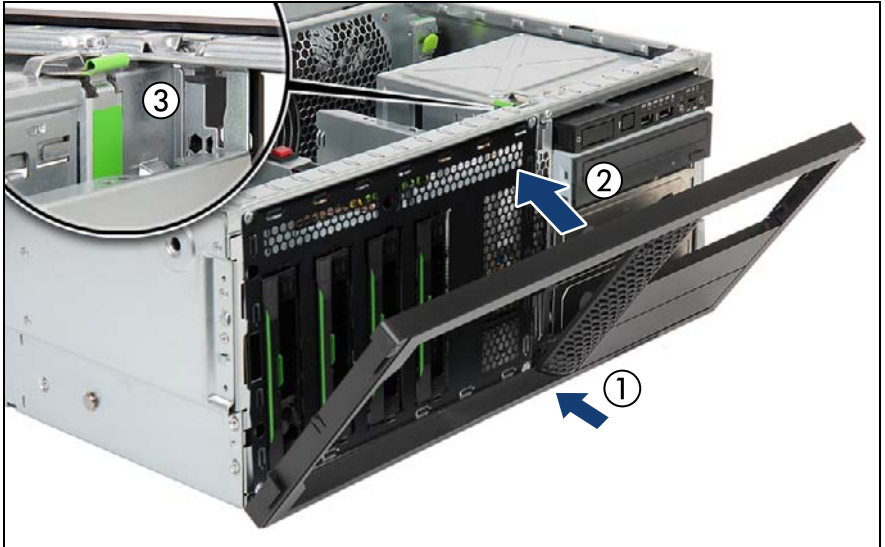

Figure 18: Installing the rack front cover

- ▶ Fit the rack front cover on the server front (1).
- ▶ Carefully fold close (2) until the upper locking latch engages (3).
- ▶ Secure the rack front cover to the chassis with two screws on either side (see figure 7 on page 56).
- ▶ Insert and slide the ID card into its slot until it locks in place (see figure 6 on page 56).

4.5.2.2 Installing the top cover

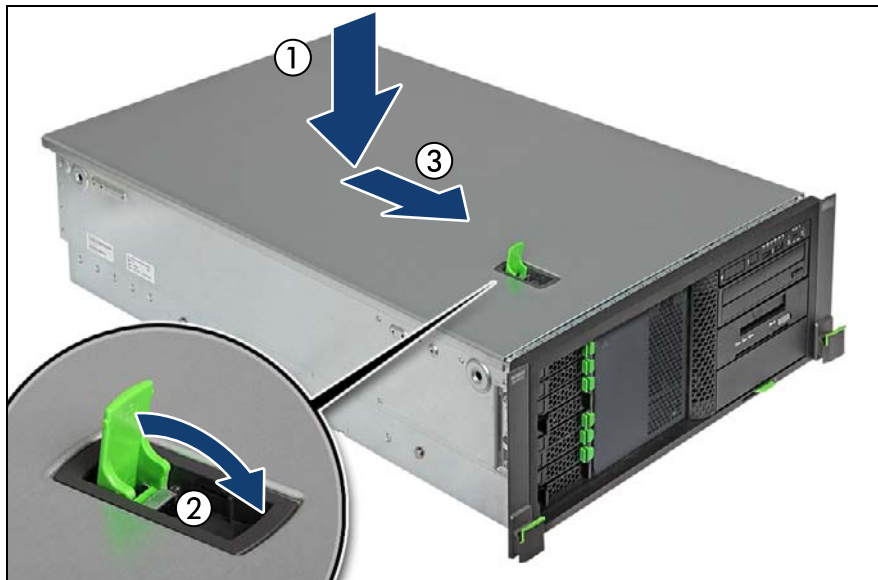

Figure 19: Installing the top cover (rack server)

- ▶ Check if the locking lever on the top cover is open.
- ▶ Lower the top cover onto the chassis, recessed by 2 cm (1).
- ▶ Close the locking lever on the top cover (2). This will slide the top cover shut engaging the locking mechanism (3).

4.5.2.3 Mounting the server in the rack

**CAUTION!**

At least two people are needed to position the server on the rack rails.
(For the Japanese market, please refer to "安全上のご注意".)

**For configurations below 32 kg:**

At least two people are needed to lift the server into the rack cabinet.

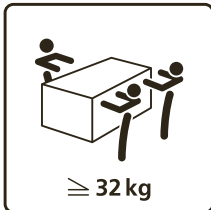
**For configurations below 55 kg:**

At least three people are needed to lift the server into the rack cabinet.

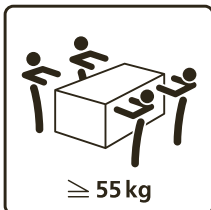
**For configurations above 55 kg:**

At least four people are needed to lift the server into the rack cabinet.

Additionally, a lifter is required in the following cases:

- The server weighs more than 50 kg.
- The server weighs more than 21 kg and is to be installed above the height of 25 U.

When using a lifter, this installation procedure needs to be carried out by maintenance personnel.

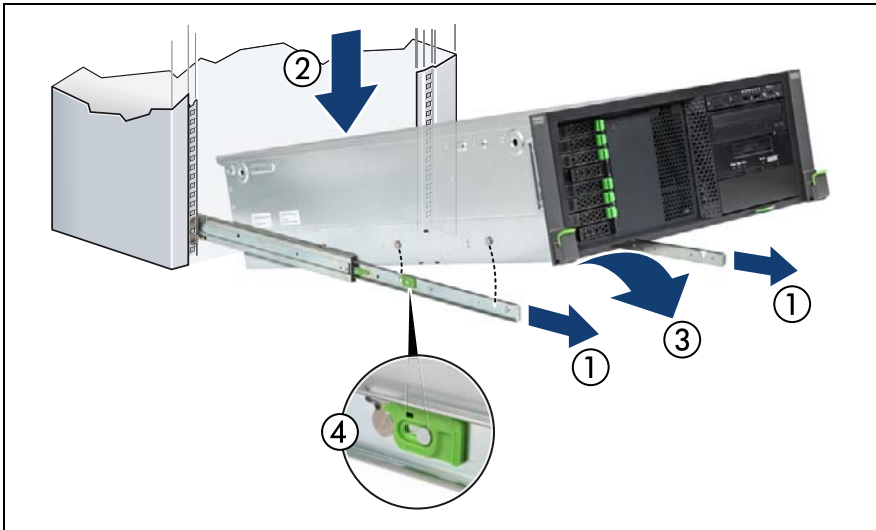

Figure 20: Mounting the server onto the rack rails

- ▶ Fully extend the telescopic rails until they lock in place (1).
- ▶ At a slight angle, lower the server onto the rear mounting point on the telescopic rails (2).
- ▶ Fold down the server (3). Ensure that all six rack mounting bolts are properly seated in the mounting points on the telescopic rails and that the locking bars engage (4).

4.5.2.4 Sliding the server into the rack

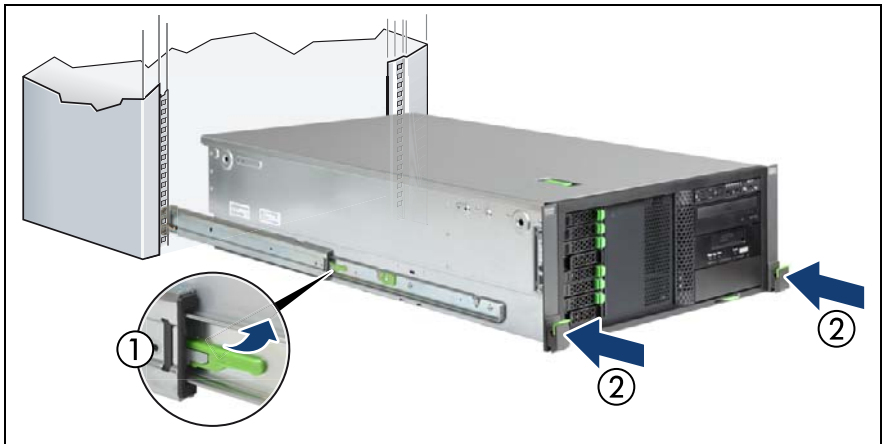

Figure 21: Sliding the server into the rack

- ▶ Pull up on the locking latch on both telescopic rails (1).
- ▶ Slide the server inside the rack as far as it will go (2) until the quick release levers lock into place.
- ▶ Reconnect all cables except the power cord to the server rear.



If you are not using a cable mounting arm (CMA kit), ensure that the rear cables are long enough not to be strained or damaged when extending the server out of the rack.

Use cable ties to prevent loose cables from blocking the air flow.

4.5.3 Tower model

4.5.3.1 Installing the front cover



Figure 22: Installing the front cover (tower server) (A)

- ▶ Hook the two tabs of the front cover into the notches in the chassis.



Figure 23: Installing the front cover (tower server) (B)

- ▶ Fold down the front cover (1) until the locking clip on the bottom edge engage (2).
- ▶ Insert and slide the ID card into its slot until it locks in place (see figure 14 on page 61.)

4.5.3.2 Installing accessible drive and HDD bay covers

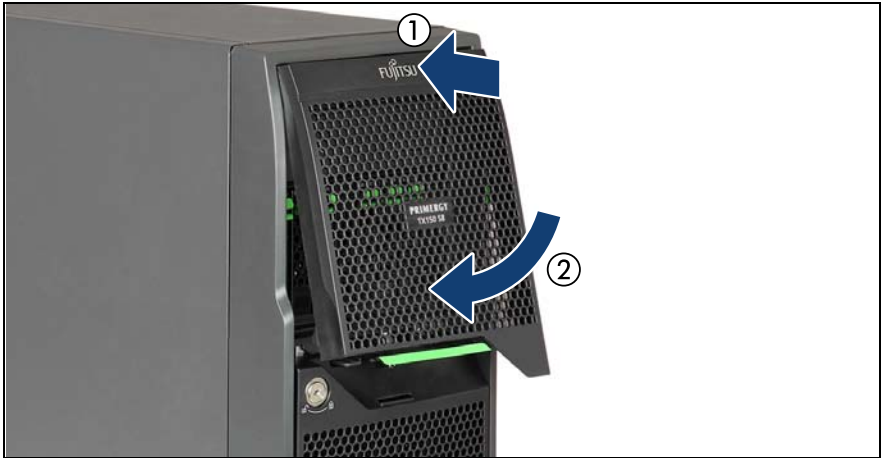

Figure 24: Installing the accessible drive bay cover

- ▶ Insert the accessible drive bay cover into the front cover as shown (1).
- ▶ Fold in the accessible drive bay cover until it locks in place (2).



Figure 25: Installing the HDD bay cover

- ▶ Insert the HDD bay cover into the front cover as shown (1).
- ▶ Fold in the HDD bay cover until it locks in place (2).

4.5.3.3 Installing the side cover



Figure 26: Installing the side cover (tower server)

- ▶ Open the locking lever on the side cover.
- ▶ Fit the side cover on the chassis, recessed by 2 cm (1).
- ▶ Close the locking lever on the side cover (2). This will slide the top cover shut engaging the locking mechanism (3).
- ▶ Reconnect all cables except the power cord to the server rear.

4.5.3.4 Locking the server



Figure 27: Locking the server

- ▶ Insert the key (1) and turn it counter-clockwise (2).
- ▶ Remove the key from the server front.

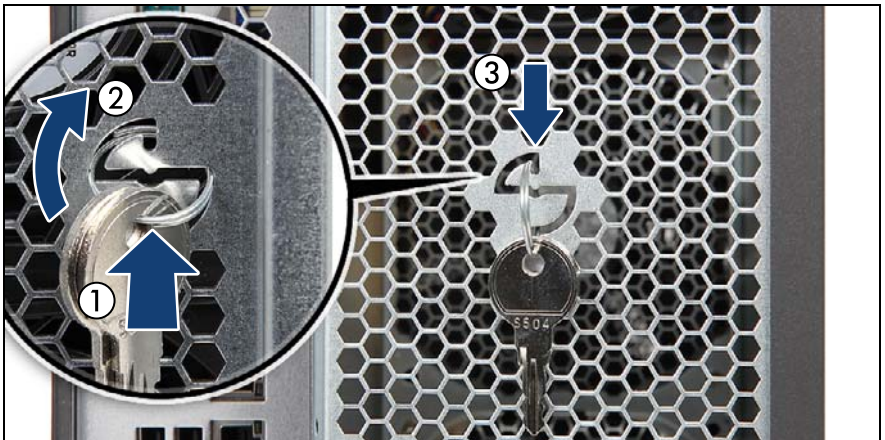

Figure 28: Storing the key ring

- ▶ Insert the key ring into the slot on the server rear (1).
- ▶ Turn the key ring clockwise by 90 degrees (2) until it latches in place as shown (3).

4.6 Connecting the server to the mains



CAUTION!

The server supports a mains voltage in the range of 100 VAC to 240 VAC. You may only operate the server if its rated voltage range corresponds to the local mains voltage.

- ▶ Connect the power cords to the power supply units.
- ▶ Connect the mains plugs to grounded mains outlets in the in-house power supply network or power outlets of the rack socket strip.



To provide true phase redundancy, the second power supply should be connected to a different AC power source from the other supply. If one AC power source should fail, the server will still continue to run.

Securing power cords

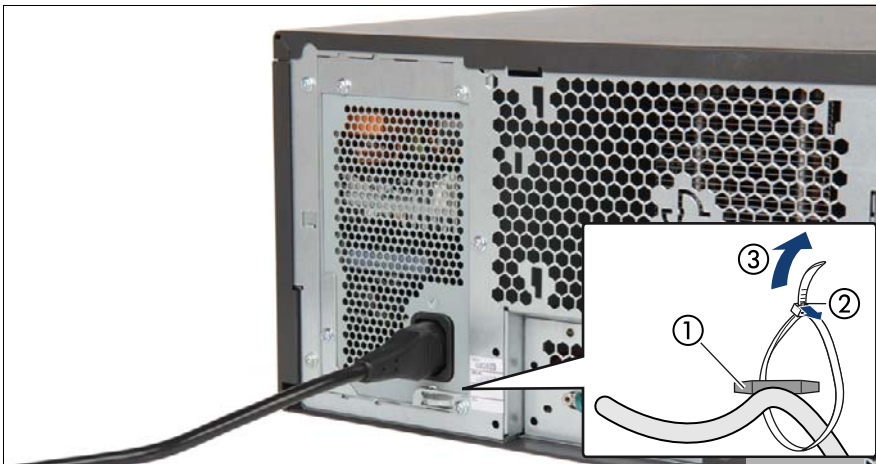

Figure 29: Securing power cord

- ▶ Loop the cable past the cable tie mounting bracket as shown (1).
- ▶ Close the cable tie around the power cord (2) and pull tight (3) to secure the power cord.

4.7 Switching on the server



CAUTION!

- Before switching on the server, make sure the top / side cover is closed. In order to comply with applicable EMC regulations (regulations on electromagnetic compatibility) and satisfy cooling requirements, the PRIMERGY TX150 S8 / TX200 S7 server must not run while the top / side cover is removed.
 - Follow the safety instructions in chapter ["Important information" on page 35](#).
- ▶ Press the On / Off button to start up the server.
 - ▶ Ensure that the power-on indicator above the On / Off button is lit green.
 - ▶ Perform the required procedures described in the concluding steps of each upgrade or maintenance task.

4.8 Handling the system fan holder

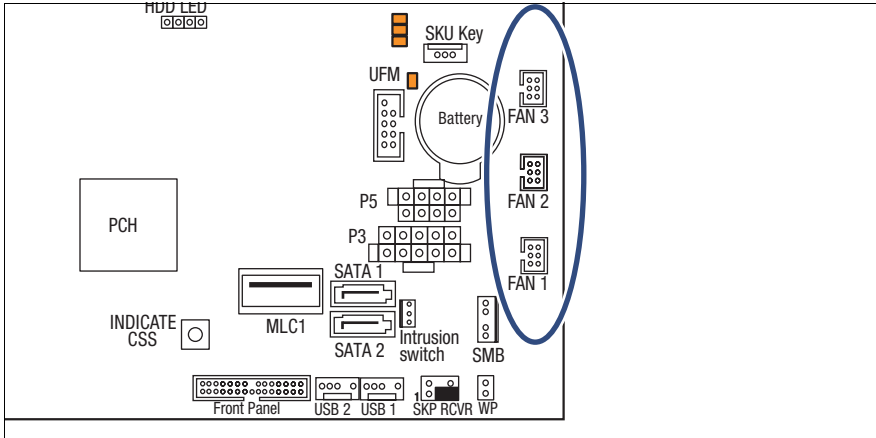

Figure 30: Position fan connectors

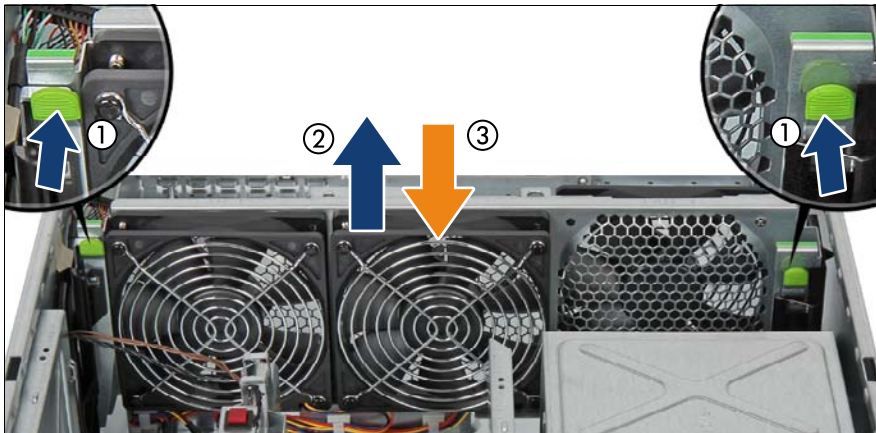

Figure 31: Handling the system fan holder

Removing the system fan holder

- ▶ Press on the two locking tabs (see close-ups) while slightly lifting up the system fan holder (1).
- ▶ Lift up the system fan holder and remove it from the chassis (2).

Installing the system fan holder

- ▶ Insert the system fan holder into its two guides (3).
- ▶ Carefully lower the system fan holder into the chassis until the two locking tabs (see close-ups) engage.

4.9 Handling the anti-tilt bracket

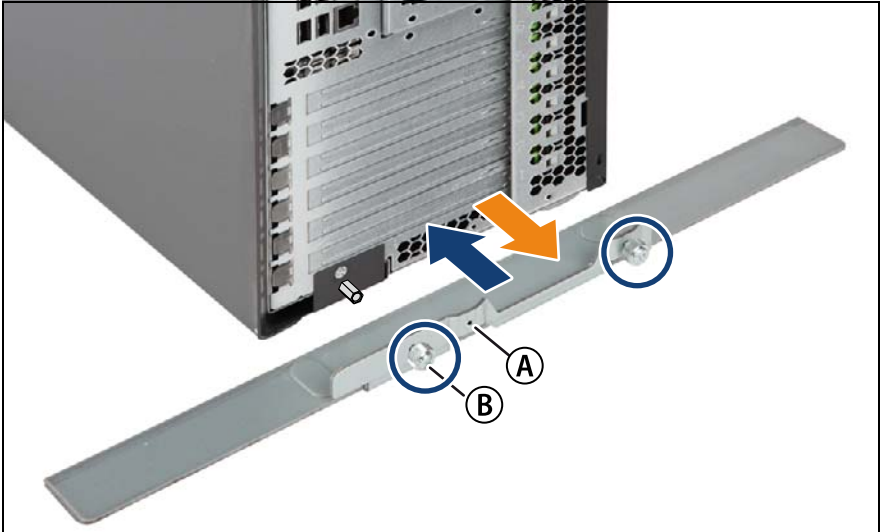

Figure 32: Handling the anti-tilt bracket

Removing the anti-tilt bracket

- ▶ Loosen the two knurled thumb screws on the anti-tilt bracket (see circles).
- ▶ Remove the anti-tilt bracket.

Installing the anti-tilt bracket

- ▶ If applicable, remove the left knurled thumb screw from the middle screw hole (A) and assemble it to the left screw hole (B).
- ▶ Fit the anti-tilt bracket onto the bottom edge of the server rear.
- ▶ Secure the anti-tilt bracket on the rear of the server with two knurled thumb screws (see circles). Screw the knurled thumb screw of the left side first.

4.10 Handling rubber feet

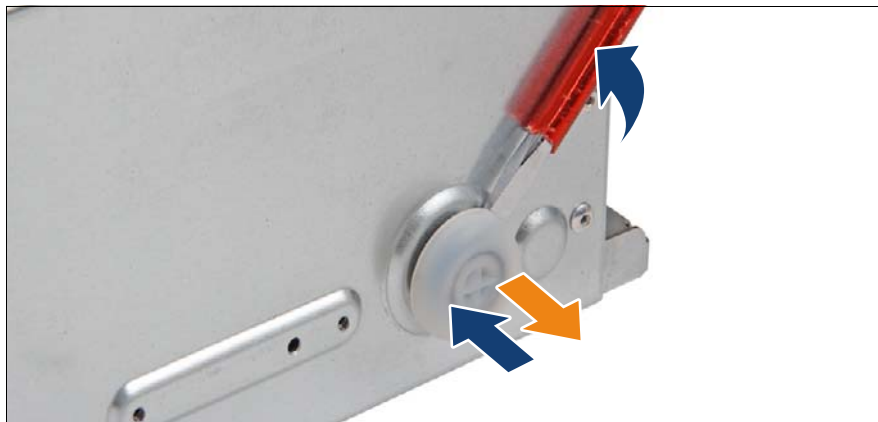

Figure 33: Handling the rubber feet

Removing rubber feet

- ▶ Lay the server on its right-hand side.



At least two people are needed to turn over a fully equipped server. Remove hard disk drives and power supply modules in order to facilitate the task.

- ▶ Using a slotted screw driver, slightly pry up on each rubber foot until it detaches.

Installing rubber feet

- ▶ Push in each rubber foot.
- ▶ Bring the server back to its vertical position.

5 Basic software procedures

5.1 Starting the maintenance task

5.1.1 Disabling BitLocker functionality

BitLocker Drive Encryption provides protection for operating system and data drives by encrypting the contents and requiring users to authenticate their credentials to access the information. On the operating system drive, BitLocker uses the compatible Trusted Platform Module (TPM) to detect if the computer's startup process has been modified from its original state.

Disabling BitLocker Drive Encryption is a temporary method for removing BitLocker protection without decrypting the drive Windows is installed on. Disable BitLocker before modifying the server's hardware configuration or startup files. Enable BitLocker again after the maintenance procedure is complete.



CAUTION!

- With BitLocker features enabled, modifying the system configuration (hardware or firmware settings) may render the system inaccessible. The system may enter Recovery Mode and require a 48-digits recovery password to return to normal operation.

Ensure to disable BitLocker drive encryption before maintaining the server.
- When disabled, BitLocker uses a plain text key instead of the Trusted Platform Module (TPM) to read encrypted files. Keep in mind that information on this drive is not secure until BitLocker has been re-enabled.
- ▶ Ask the system administrator to disable BitLocker-protection on the operating system drive, using the BitLocker setup wizard available either from the Control Panel or Windows Explorer:
 - ▶ Open BitLocker Drive Encryption by clicking the *Start* button, clicking *Control Panel*, clicking *Security*, and then clicking *Bitlocker Drive Encryption*.



Administrator permission required: If you are prompted for an administrator password or confirmation, type the password or provide confirmation.

- ▶ To temporarily disable BitLocker, click *Turn Off BitLocker*, and then click *Disable BitLocker Drive Encryption*.



In order to determine which features are accessible through the BitLocker setup wizard, modify the BitLocker Group Policy settings.

For further information on how to disable BitLocker drive encryption, please refer to the Microsoft Knowledge Base.

Fujitsu service partners will find additional information (also available in Japanese) on the Fujitsu Extranet web pages.

5.1.2 Disabling SVOM boot watchdog functionality

The ServerView Operations Manager boot watchdog determines whether the server boots within a preset time frame. If the watchdog timer expires, the system will automatically reboot.

5.1.2.1 Viewing boot watchdog settings

To view boot watchdog settings in ServerView Operations Manager, proceed as follows:

- ▶ In ServerView Operations Manager *Single System View* select *Maintenance* from the *Information / Operation* menu.
- ▶ Under *ASR&R* select the *Watchdog* tab to obtain detailed information about the current watchdog status, time out intervals and actions that are triggered if watchdog timeouts are exceeded.



For more detailed information, refer to the "ServerView Operations Manager - Server Management" user guide.

5.1.2.2 Configuring boot watchdog settings

If the system is to be started from removable boot media for firmware upgrade purposes, the Boot watchdog needs to be disabled before starting maintenance task. Otherwise, the Boot watchdog might initiate a system reboot before the flash process is complete.



CAUTION!

An incomplete firmware upgrade process may render the server inaccessible or result in damaged / destroyed hardware.

Timer settings can be configured in the BIOS or using the ServerView iRMC web frontend:

Configuring boot watchdog settings in the BIOS

- ▶ Enter the BIOS.
- ▶ Select the *Server Mgmt* menu.
- ▶ Under *Boot Watchdog* set the *Action* setting to *Continue*.
- ▶ Save your changes and exit the BIOS.



For detailed information on how to access the BIOS and modify settings, refer to the corresponding BIOS Setup Utility reference manual.

Configuring boot watchdog settings using the iRMC web frontend

- ▶ Enter the ServerView iRMC web frontend.
- ▶ Select the *Server Management* menu.
- ▶ Under *Watchdog Settings* select *Continue* from the *Boot Watchdog* drop down list.
- ▶ Click *Apply* for the changes to take effect.



For detailed information on iRMC settings, refer to the "Integrated Remote Management Controller" user guides.

5.1.3 Removing backup and optical disk media

- ▶ Ask the system administrator to eject all remaining backup or optical media from the backup or optical disk drive before removing it from the server.
- ▶ If the backup media cannot be ejected by conventional means, and it is mandatory that the cartridge be removed prior to returning the drive for repair or disposing it, a manual tape extraction needs to be performed.

For further information on "forcible" tape ejection, please refer to the "Tape Facts" guide available to Fujitsu service partners from the following [https](#) address:

<https://partners.ts.fujitsu.com/com/service/ps/Servers/PRIMERGY/Pages/TapeFacts.aspx>

For the Japanese market, please contact Fujitsu support, if "forcible" tape ejection is necessary.

 Fujitsu does not assume responsibility for any damage to the tape drive, the data cartridge / tape or for the loss of any data resulting from manual tape extraction procedures.

5.1.4 Verifying and configuring the backup software solution

 This task only applies to the Japanese market.

Depending on the backup software solution, it may be necessary to disable or delete the backup drive from the backup software drive list before starting the maintenance task.

This is the case for the following backup software solution:

– BackupExec

 Procedures may differ depending on the backup software. For details, refer to the dedicated documentation provided separately.

Further information on suitable backup software solutions and related documentation is available to Fujitsu service partners from the Fujitsu Extranet pages.

5.1.5 Note on server maintenance in a Multipath I/O environment

When booting your server offline from the ServerView Suite DVD 1 to perform an offline driver update using the ServerView Update DVD or collect diagnostic data using PrimeCollect in a Multipath I/O environment, there is a risk of damaging the system configuration which may leave the system unable to boot.

This is a known restriction of Windows PE with Multipath drivers.

Before using the ServerView Update DVD or PrimeCollect in an offline environment, Fujitsu recommends to properly shut down the server and to disconnect all external I/O connections (like LAN or FC cables) from the system. Only keep mouse, keyboard, video cable and AC power cord connected.

Continue as follows:

- ▶ If performing an offline driver update, first of all prepare the ServerView Update DVD:
 - ▶ Download the latest ServerView Update DVD image from the Fujitsu FTP server at:

<ftp://ftp.ts.fujitsu.com/images/serverview>

- ▶ Burn the image to a DVD.

For the Japanese market:

- ▶ Locate, download and burn the ServerView Update DVD image available from the following URL:

<http://jp.fujitsu.com/platform/server/primergy/products/note/svsdvd/dvd/>

- ▶ Ensure that all external I/O connections have been removed from the server.



Ensure that all external I/O connections are uniquely identified so that you can reconnect them into their original locations after concluding the task.

- ▶ Switch on the server.
- ▶ Right after switching on the server, insert the ServerView Suite DVD 1 into the DVD drive and close the drive tray.
The server will now boot from the DVD.
- ▶ After the boot process is complete, select your preferred GUI language.
- ▶ In the initial Installation Manager startup window, choose either *Update Manager Express* or *PrimeCollect* from the *Installation Manager mode* section.
- ▶ Click *Continue* to proceed.

If *Update Manager Express* has been selected, insert the ServerView Update DVD into the DVD drive before proceeding.

- ▶ Finish the intended maintenance task. For further information, refer to the following manuals:
 - ServerView Update Manager Express:

"Local System Update for PRIMERGY Servers" user guide

- PrimeCollect:
"PrimeCollect" user guide
- ▶ After the update or diagnostic procedure has been completed, shut down the server, reconnect all external I/O connections and bring the system back to normal operation.
- ▶ If necessary, perform this procedure for all remaining servers within the Multipath environment.

5.1.6 Switching on the ID indicator

When working in a datacenter environment, switch on the ID indicator on the front and rear connector panels of the server for easy identification.



For further information, refer to section "[Locating the defective server](#)" on [page 47](#) or to the "ServerView Suite Local Service Concept (LSC)" manual.

Using the ID button on the front panel

- ▶ Press the ID button on the front panel to switch on the system identification LEDs.



For further information, refer to section "[Front panel controls and indicators](#)" on [page 424](#).

Using ServerView Operations Manager

- ▶ In ServerView Operations Manager *Single System View* and press the *Locate* button in the title bar to switch on the ID indicators.

5.2 Completing the maintenance task

5.2.1 Updating or recovering the system board BIOS and iRMC

After replacing the system board, it is essential to upgrade the BIOS and iRMC to the latest version. The latest BIOS and iRMC versions are available from the Fujitsu support internet pages at:

<http://ts.fujitsu.com/support/> (EMEA market)

<http://jp.fujitsu.com/platform/server/primergy/downloads/> (Japanese market)



Fujitsu does not assume responsibility for any damage done to the server or for the loss of any data resulting from BIOS updates.

5.2.1.1 Updating or recovering the system board BIOS

BIOS flash procedure



For the Japanese market, follow the instructions provided separately.

- ▶ Prepare a USB stick with the following files:
 - Update tool
 - *Startup.nsh* (which will execute the update tool)
 - BIOS image file for update (16 MB with header information)
- ▶ Connect the USB stick to the USB port.
- ▶ Restart the server.

The system will detect the USB stick and start DOS.

- ▶ Enter `cd DOS` and press **Enter** in order to change to the *DOS* directory on the USB stick.
- ▶ Enter `DosFlash.BAT` and press **Enter** to start the BIOS flash process.



CAUTION!

Do not interrupt the BIOS flash process after it has started. If the process is interrupted, the system BIOS may be permanently corrupted.

- ▶ After completion of the flash process, remove the USB stick and restart the server.

BIOS recovery procedure



For the Japanese market, follow the instructions provided separately.

- ▶ Prepare a USB stick with the following files:
 - Update tool
 - *Startup.nsh* (which will execute the update tool)
 - BIOS image file for update (16 MB with header information)
- ▶ Ensure that the server has been shut down and disconnected from the mains as described in section ["Shutting down the server" on page 50](#).
- ▶ Open the side / top cover as described in section ["Getting access to the component" on page 51](#).
- ▶ Enter BIOS recovery mode using the onboard jumpers.



For detailed information on jumper settings, refer to section ["Onboard settings" on page 426](#).

- ▶ Close the side / top cover as described in section ["Reassembling" on page 64](#).
- ▶ Connect the USB stick to the USB port.
- ▶ Connect the server to the mains as described in section ["Connecting the server to the mains" on page 74](#).
- ▶ Press the On / Off button to start up the server.

The system will detect the USB stick and the BIOS recovery process will be performed.



CAUTION!

Do not interrupt the BIOS recovery process after it has started. If the process is interrupted, the system BIOS may be permanently corrupted.

- ▶ After completion of the flash process, shut down the server.
- ▶ Open the side / top cover as described in section ["Getting access to the component" on page 51](#).
- ▶ Disable BIOS recovery mode using the onboard jumpers:



For detailed information on jumper settings, refer to section "Onboard settings" on page 426.

- ▶ Close the side / top cover as described in section "Reassembling" on page 64.

5.2.1.2 Updating or recovering the iRMC

iRMC flash procedure



For the Japanese market, follow the instructions provided separately.

- ▶ Prepare a USB stick including the bootable iRMC firmware update image.
- ▶ Connect the USB stick to the USB port.



Ensure that only the USB device with the iRMC firmware is connected to the USB port. Remove all other USB devices temporarily.

- ▶ Restart the server.
- ▶ The system will detect the USB stick.



If the BIOS cannot identify the USB stick, the pop-up message `Failed to boot for Emergency flash. Please Reset now.` will show up in the center of the screen.

- ▶ Choose one of the following options from the update tool menu to start the iRMC update process:

Normal Choose this option to update an existing system board.

Initial Choose this option if the system board has been replaced prior to the iRMC update procedure. This option will perform all relevant flash procedures in a row, including the iRMC firmware and bootloader.



CAUTION!

Do not interrupt the iRMC upgrade process after it has started. If the process is interrupted, the iRMC BIOS may be permanently corrupted.



If the iRMC does not work after flashing, disconnect the system from the mains and reconnect it again.

- ▶ After completion of the flash process, remove the USB stick and restart the server.

iRMC recovery procedure



For the Japanese market, follow the instructions provided separately.

- ▶ Prepare a USB stick including the bootable iRMC firmware update image.
- ▶ Ensure that the server has been shut down and disconnected from the mains as described in section ["Shutting down the server" on page 50](#).
- ▶ Connect the USB stick to the USB port.



Ensure that only the USB device with the iRMC firmware is connected to the USB port. Remove all other USB devices temporarily.

- ▶ Connect the server to the mains while pushing the ID button on the front panel. Ask a second person to help you if necessary.
- ▶ Ensure that the Global Error indicator and the ID indicator are flashing to indicate that the server is entering the iRMC recovery state.
- ▶ Press the Power On / Off button. The system starts the POST process.



In iRMC recovery mode, the “FUJITSU” logo does not show up.

- ▶ The system will detect the USB stick.



If the BIOS cannot identify the USB stick, the pop-up message `Failed to boot for Emergency flash. Please Reset now.` will show up in the center of the screen.

- ▶ Choose the `Recovery_L` option from the update tool menu to start the iRMC update process.



CAUTION!

Do not interrupt the iRMC upgrade process after it has started. If the process is interrupted, the iRMC BIOS may be permanently corrupted.



If the iRMC does not work after flashing, disconnect the system from the mains and reconnect it again.

- ▶ Shut down the server by pressing the power On / Off button.
- ▶ Disconnect the server from the mains to exit the iRMC recovery state.

5.2.2 Verifying system information backup / restore

To avoid the loss of non-default settings when replacing the system board, a backup copy of important system configuration data is automatically stored from the system board NVRAM to the Chassis ID EPROM. After replacing the system board the backup data is restored from the Chassis ID board to the new system board.

In order to verify whether the backup or restore process has been successful, check the System Event Log (SEL) using the ServerView Operations Manager (see also section "[Viewing and clearing the System Event Log \(SEL\)](#)" on page 97).

After replacing the system board

- ▶ Check the SEL log files as described in section "[Viewing and clearing the System Event Log \(SEL\)](#)" on page 97 to verify whether the backup data on the Chassis ID EPROM has been restored to the system board:

```
Chassis IDPROM: Restore successful
```

After replacing the Chassis ID EPROM



In case of the PRIMERGY TX150 S8 / TX200 S7 server, the Chassis ID EPROM is integrated on the front panel board.

- ▶ Check the SEL log files as described in section "[Viewing and clearing the System Event Log \(SEL\)](#)" on page 97 to verify whether a backup copy of the system board settings has been transferred to the Chassis ID EPROM:

```
Chassis IDPROM: Backup successful
```

5.2.3 Updating RAID controller firmware

After replacing the RAID controller, it is essential to upgrade the firmware to the latest version. The latest RAID controller firmware version is available from the Fujitsu support web pages at:

<http://ts.fujitsu.com/support/> (EMEA market)

<http://jp.fujitsu.com/platform/server/primergy/downloads/> (Japanese market)



Fujitsu does not assume responsibility for any damage done to the server or for the loss of any data resulting from firmware updates.

For the Japanese market, follow the instructions provided separately.

Using the ServerView Update Manager

For a detailed description on how to update the RAID controller firmware using the ServerView Update Manager or Update Manager Express (UME), please refer to the following manuals:

- ServerView Update Manager: "ServerView Update Management" user guide
- ServerView Update Manager Express: "Local System Update for PRIMERGY Servers" user guide

Using the flash tool

The latest firmware files are available as ASPs (Autonomous Support Packages) for Windows or as DOS tools from the Fujitsu support web pages at:

<http://ts.fujitsu.com/support/> (EMEA market)

<http://jp.fujitsu.com/platform/server/primergy/downloads/> (Japanese market)

- ▶ Select *Drivers & Downloads*.
- ▶ From the *Select Product* drop down lists, choose your PRIMERGY server or enter its serial or ident number into the search field.
- ▶ Select your operating system and version.
- ▶ Select the desired component type (e.g. SAS RAID).
- ▶ Select your controller from the device list to expand a compilation of available drivers and firmware.
- ▶ Select the desired file and click *Download* for further instructions.

5.2.4 Enabling Option ROM scan

In order to configure an expansion card that has been installed or replaced, the card's Option ROM has to be enabled in the system board BIOS. The card's firmware is called by the system BIOS upon reboot and can be entered and configured.

Option ROM can be enabled permanently (e.g. in case of a boot controller that may require frequent setup) or temporarily for one-time configuration. When permanently enabling a controllers's Option ROM, keep in mind that only two Option ROMs can be activated in the system board BIOS at a time.

- ▶ Enter the BIOS.

- ▶ From the *Advanced* menu select *Option ROM Configuration*.
- ▶ Identify the desired PCI slot and set its *Launch Slot # OpROM* setting to *Enabled*.
- ▶ Save your changes and exit the BIOS.



Up to two Option ROMs can be activated in the system board BIOS at a time.

For detailed information on how to access the BIOS and modify settings, refer to corresponding BIOS Setup Utility reference manual.

When the enabled expansion card is initialized during the POST phase of the boot sequence, a key combination is displayed temporarily to enter the expansion card's firmware.

- ▶ Press the displayed key combination.
- ▶ Modify the expansion card firmware options as desired.
- ▶ Save your changes and exit the firmware.



The expansion card's option ROM can now be disabled in the system board BIOS.

Exception: If the expansion card controls a permanent boot device, the card's Option ROM has to remain enabled.

5.2.5 Verifying and configuring the backup software solution



This task only applies to the Japanese market.

Disabling backup drives

Depending on the backup software solution, it may be necessary to disable or delete the backup drive from the backup software drive list and reconfigure backup jobs after completing the maintenance task.

This is the case for the following backup software solutions:

- Netvault for Windows
- ARCServe
- BackupExec



Procedures may differ depending on the backup software. For details, refer to the dedicated documentation provided separately.

Further information on suitable backup software solutions and related documentation is available to Fujitsu service partners from the Fujitsu Extranet pages.

Re-enabling backup drives

If a backup drive has been disabled or deleted from the backup software drive list as described in section [5.1.4 on page 82](#), it has to be re-enabled to complete the maintenance task.

- ▶ Re-enable backup drives and revise backup software settings and cronjobs.



Detailed information on suitable backup software solutions and related documentation is available to Fujitsu service partners from the Fujitsu Extranet pages

5.2.6 Resetting the boot retry counter

The boot retry counter is decremented from its preset value every time the POST watchdog initiates a system reboot. When the value has reached '0', the system will shut down and power off.

5.2.6.1 Viewing the boot retry counter

The current boot retry counter status is available in the BIOS:

- ▶ Enter the BIOS.
- ▶ Select the *Server Mgmt* menu.
- ▶ Under *Boot Retry Counter* the current number of remaining boot attempts is displayed. The value is further decremented with every failed boot attempt or system reboot resulting from critical system errors.
- ▶ Exit the BIOS.

5.2.6.2 Resetting the boot retry counter

The boot retry counter should be reset to its original value concluding every service task.



Please note, if the customer does not know about the original boot retry values:

If the system boots up and no further errors occur within 6 hours after that successful boot attempt, the boot retry counter will automatically be reset to its default value. Please take into account, that the specified number of boot attempts can only be determined after this period of time.

If the customer knows about the original boot retry values, proceed as follows to reset or configure the boot retry counter:

Resetting the boot retry counter in the BIOS

- ▶ Enter the BIOS.
- ▶ Select the *Server Mgmt* menu.
- ▶ Under *Boot Retry Counter* press the + or - keys to specify the maximum number of boot attempts (0 to 7).
- ▶ Exit the BIOS.

Resetting the boot retry counter using the ServerView Operations Manager

- ▶ In the ServerView Operations Manager *Administration* view, select *Server Configuration*.
- ▶ If more than one server is managed in SVOM, select the target server and click *Next*.
- ▶ From the *Server Configuration* menu pane, choose *Restart Options*.
- ▶ Under *Reboot Retries*, specify the maximum number of boot attempts (0 to 7) in the *Default for reboot tries* field.

Resetting the boot retry counter using iRMC web frontend

- ▶ Enter the ServerView iRMC web frontend.
- ▶ Select the *Server Management* menu.
- ▶ The following boot retry counter settings are available under *ASR&R Options*:
 - ▶ Under *Retry counter max* specify the maximum number of attempts to boot the operating system (0 to 7).

- ▶ Under *Retry counter* the current number of remaining boot attempts is displayed. Overwrite this value with the maximum number of boot attempts specified above in order to reset the boot retry counter.
- ▶ Click *Apply* for the changes to take effect.



For detailed information on iRMC settings, refer to the "Integrated Remote Management Controller" user guides.

5.2.7 Enabling SVOM boot watchdog functionality

If ServerView Operations Manager boot watchdog functionality has been disabled for firmware upgrade purposes (see section [5.1.2 on page 80](#)), it has to be re-enabled to complete the maintenance task.

Timer settings can be configured in the BIOS or using the ServerView iRMC web frontend:

Configuring boot watchdog settings in the BIOS

- ▶ Enter the BIOS.
- ▶ Select the *Server Mgmt* menu.
- ▶ Under *Boot Watchdog* set the *Action* setting to *Reset*.
- ▶ Save your changes and exit the BIOS.



For detailed information on how to access the BIOS and modify settings, refer to the corresponding BIOS Setup Utility reference manual.

Configuring boot watchdog settings using the iRMC web frontend

- ▶ Enter the ServerView iRMC web frontend.
- ▶ Select the *Server Management* menu.
- ▶ Under *Watchdog Settings* ensure that the check box next to *Boot Watchdog* is selected. From the drop down list choose *Reset* and specify the desired timeout delay.
- ▶ Click *Apply* for the changes to take effect.



For detailed information on iRMC settings, refer to the "Integrated Remote Management Controller" user guides.

5.2.8 Enabling replaced components in the system BIOS

When a processor, an expansion card, or a memory module fails, the defective component will be set to *Disabled* or *Failed* in the system BIOS. The server will then reboot with only the intact hardware components remaining in the system configuration. After replacing the defective component, it needs to be re-enabled in the system board BIOS.

- ▶ Enter the BIOS.
- ▶ Select the *Advanced* menu.
- ▶ Select the status menu of the desired component:

- Processors: *CPU Status*



This option is only available for multi-processor systems.

- Memory: *Memory Status*
- Expansion cards: *PCI Status*

- ▶ Reset replaced components to *Enable*.
- ▶ Save your changes and exit the BIOS.



For detailed information on how to access the BIOS and modify settings, refer to the corresponding BIOS Setup Utility reference manual.

5.2.9 Verifying the memory mode

If a memory module fails, the server will reboot and the defective module will be disabled. As a result, the current operation mode (e.g. Mirrored Channel mode) may no longer be available due to a lack of identical memory module pairs. In this case, the operation mode will automatically revert to Independent Channel Mode.



For detailed information on memory operation modes available for your server, refer to section "[Memory sequence](#)" on page 243.

After replacing the defective module(s) the memory operation mode is automatically reset to its original state. It is recommended to verify that the operation mode has been correctly.

- ▶ Enter the BIOS.

- ▶ Select the *Advanced* menu.
- ▶ Under *Memory Status* verify that none of the memory modules are marked as *Failed*.
- ▶ Save your changes (if applicable) and exit the BIOS.

 For detailed information on how to access the BIOS and modify settings, refer to the corresponding BIOS Setup Utility reference manual.

5.2.10 Verifying the system time settings

 This task only applies to Linux environments.

After the system board has been replaced, the system time is set automatically. By default, the RTC (Real Time Clock) time standard is set as the local time.

If a Linux OS is used and the hardware clock has been configured as UTC (Universal Time, Coordinated) in the operating system, the BMC local time may not be mapped correctly.

- ▶ After replacing the system board, ask the system administrator whether the RTC or UTC time standard is to be used as system time.

 If the system time (RTC) is set to UTC, the SEL (System Event Log) time stamps may differ from the local time.

- ▶ Enter the BIOS.
- ▶ Select the *Main* menu.
- ▶ Under *System Time* and *System Date* specify the correct time and date.

 By default, the system time set in the BIOS is RTC (Real Time Clock) local time. If your IT infrastructure relies on universally accepted time standards, set the *System Time* to UTC (Universal Time, Coordinated) instead. Greenwich Mean Time (GMT) can be considered equivalent to UTC.

- ▶ Save your changes and exit the BIOS.

 For detailed information on how to access the BIOS and modify settings, refer to the corresponding BIOS Setup Utility reference manual

5.2.11 Viewing and clearing the System Event Log (SEL)

5.2.11.1 Viewing the SEL

You can view the System Event Log (SEL) using the ServerView Operations Manager or the ServerView iRMC web frontend:

Viewing the SEL in ServerView Operations Manager

- ▶ In ServerView Operations Manager *Single System View* select *Maintenance* from the *Information / Operation* menu.
- ▶ Under *Maintenance* select *System Event Log*.
- ▶ Select the message type(s) you want to display:
 - Critical events
 - Major events
 - Minor events
 - Informational events



Note on the SVOM Driver Monitor

The *Driver Monitor* view gives you an overview of the monitored components as well as the associated events contained in the system event log on the managed server.

Under *Monitored Components* the monitored components are listed. If a component has the status *Warning* or *Error*, you can select it in the list and click *Acknowledge*. This confirms the event on the server side. You may have to log on to the server beforehand. The status of the component will then be reset to *ok*. To see the new status you must refresh the *Driver Monitor* view with *Refresh*.



For detailed information on how to view and sort the SEL using ServerView Operations Manager, refer to the "ServerView Operations Manager - Server Management" user guide.

Viewing the SEL using the iRMC web frontend

- ▶ Enter the ServerView iRMC web frontend.
- ▶ Select the *Event Log* and choose the *Internal Event Log* submenu.

- ▶ Under *Internal Event Log Content* the SEL is being displayed. In order to filter the list, select the check boxes next to the desired event types and press *Apply* for the changes to take effect.



For detailed information on iRMC settings, refer to the "Integrated Remote Management Controller" user guides.

5.2.11.2 Clearing the SEL

You can clear the System Event Log (SEL) using the ServerView iRMC web frontend:

- ▶ Enter the ServerView iRMC web frontend.
- ▶ Select the *Event Log* and choose the *Internal Event Log* submenu.
- ▶ Under *Internal Event Log Information* click *Clear Internal Event Log* to clear the SEL.



For detailed information on iRMC settings, refer to the "Integrated Remote Management Controller" user guides.

5.2.12 Updating the NIC configuration file in a Linux environment

In order to prevent errors caused by changing network device names (*eth<x>*), it is recommended to store the MAC address (hardware address) of a network interface card in the related NIC configuration file of the Linux OS.

When replacing a network controller or the system board with onboard LAN controllers in a server running Linux OS, the MAC address will change but not automatically be updated in the definition file.

In order to prevent communication problems, it is necessary to update the changed MAC address stored in the related *ifcfg-eth<x>* definition file.

To update the MAC address, proceed as follows:



Procedures may differ depending on your Linux OS or the definition file on the client system. Use the following information as reference. Ask the system administrator to change the definition file.

- ▶ After replacing a network controller or the system board, switch on and boot the server as described in section ["Switching on the server" on page 75](#).

kudzu, the hardware configuration tool for Red Hat Linux, will launch at boot and detect the new and / or changed hardware on your system.



kudzu may not launch at boot depending on the client's environment.

- ▶ Select *Keep Configuration* and *Ignore* to complete the boot process.
- ▶ Use the *vi* text editor to specify the MAC address in the `HWADDR` section of the *ifcfg-eth<x>* file:



The MAC address can be found on the type label attached to the system board or network controller.

Example:

In order to modify the definition file for network controller 1, enter the following command:

```
# vi /etc/sysconfig/network-scripts/ifcfg-eth1
```

In *vi*, specify the new MAC address as follows:

```
HWADDR=xx:xx:xx:xx:xx:xx
```

- ▶ Save and close the definition file.
- ▶ For the changes to take effect, you need to reboot the network by entering the following command:

```
# service network restart
```



If the system board or network controller offers multiple LAN ports, it is necessary to update the remaining *ifcfg-eth<x>* definition files accordingly.

- ▶ Update the NIC configuration file to reflect the new card sequence and MAC address.

5.2.13 Enabling BitLocker functionality

If BitLocker Drive Encryption has been disabled for maintenance purposes (see section "[Disabling BitLocker functionality](#)" on page 79), it has to be re-enabled to complete the service task.

 If BitLocker Drive Encryption has been disabled prior to replacing components you won't be asked for a recovery key when rebooting the server after the maintenance task. However, if BitLocker functionality has not been disabled, Windows will enter recovery mode and ask you to input recovery key for further booting.

- ▶ In this case, ask the system administrator to enter the recovery key in order to boot the operating system.
- ▶ Ask the system administrator to enable BitLocker-protection on the operating system drive, using the BitLocker setup wizard available either from the Control Panel or Windows Explorer.
 - ▶ Open Bitlocker Drive Encryption by clicking the *Start* button, clicking *Control Panel*, clicking *Security*, and then clicking *Bitlocker Drive Encryption*.

 Administrator permission required: If you are prompted for an administrator password or confirmation, type the password or provide confirmation.

- ▶ To enable a temporarily disabled BitLocker, click *Turn On BitLocker*.
- ▶ Follow the instructions in the BitLocker Setup wizard.

 For further information on how to enable BitLocker drive encryption, please refer to the Microsoft Knowledge Base.

Fujitsu service partners will find additional information (also available in Japanese) on the Fujitsu Extranet web pages.

5.2.14 Performing a RAID array rebuild

After replacing a hard disk drive that has been combined into a RAID array, RAID rebuild will be performed completely unattended as a background process.

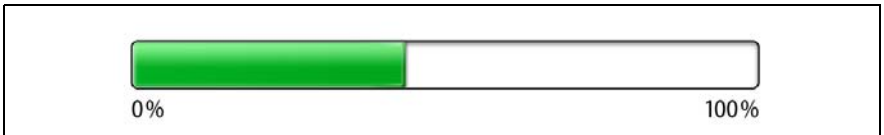

Figure 34: Progress bar (RAID array rebuild)



CAUTION!

The system is now operational, however, data redundancy will not be available until the RAID array rebuild is complete. Depending on the hard disk drive capacity the overall process can take up to several hours, in some cases even days.



You may notice a slight performance impact during rebuild.

5.2.15 Looking up changed MAC / WWN addresses

When replacing a network controller, the MAC (Media Access Control) and WWN (World Wide Name) addresses will change.



In addition to the procedures described below, MAC / WWN addresses can also be found on the type label attached to a network controller or system board.

5.2.15.1 Looking up MAC addresses

- ▶ Enter the BIOS.
- ▶ Depending on the number of network controllers in your system, you will find one or several *Port Configuration* menu items.

Use the arrow key  to scroll to the right and browse all available tabs.

Each *Port Configuration* tab will display detailed information on the related network controller, including its MAC address.

- ▶ Note down the new 12-digit MAC address.

- ▶ Press **[Esc]** to exit the BIOS.
- ▶ Inform the customer about the changed MAC address.

5.2.15.2 Looking up WWN addresses

Emulex FC / FCoE adapters

- ▶ Enable the network controller's Option ROM in the system board BIOS as described in section ["Enabling Option ROM scan" on page 90](#).
- ▶ Restart the server.
- ▶ During boot, as soon as the Emulex BIOS utility option appears, press **[ALT]+[E]** or **[CTRL]+[E]**.
- ▶ Under *Emulex Adapters in the System* you will find all available Emulex adapters and their WWN addresses.
- ▶ Note down the new 16-digit WWN address.
- ▶ Press **[Esc]** to exit the Emulex BIOS utility.
- ▶ Inform the customer about the changed WWN address.

QLogic FC adapters

- ▶ Enable the network controller's Option ROM in the system board BIOS as described in section ["Enabling Option ROM scan" on page 90](#).
- ▶ Restart the server.
- ▶ During boot, as soon as the QLogic BIOS utility option appears, press **[ALT]+[Q]** or **[CTRL]+[Q]**.
- ▶ Under *Select Host Adapter* use the arrow keys **[↑]/[↓]** to select the desired FC / FCoE adapter and press **[Enter]**.
- ▶ From the *Fast!UTIL Options* menu, select *Configuration Settings*, and press **[Enter]**.
- ▶ From the *Configuration Settings* menu, select *Adapter Settings*, and press **[Enter]**.
- ▶ Note down the new 16-digit WWN address found under *Adapter Port Name*.
- ▶ Press **[Esc]** to return to the main menu and exit the QLogic BIOS utility.
- ▶ Inform the customer about the changed WWN address.

5.2.16 Using the Chassis ID Prom Tool

The Chassis ID EPROM located on a dedicated Chassis ID board or on your server's front panel board contains system information like server name and model, housing type, serial number and manufacturing data.

In order to integrate your system into the ServerView management environment and to enable server installation using the ServerView Installation Manager, system data needs to be complete and correct.

After replacing the Chassis ID EPROM, system information has to be entered using the Chassis ID Prom tool. The tool and further instructions are available to maintenance personnel from the Fujitsu Technology Solutions Extranet:

<https://partners.ts.fujitsu.com/com/service/ps/Servers/PRIMERGY/>

- ▶ Select your PRIMERGY system from the main area of the page.
- ▶ From the categories selection, choose *Software & Tools Documentation*.
- ▶ In the *Tools* area click *Tools: Chassis-IDProm Tool* to download the file (*tool-chassis-Idprom-Tool.zip*).



For the Japanese market, follow the instructions provided separately.

5.2.17 Configuring LAN teaming

Use ServerView Operations Manager to obtain detailed information on existing LAN teams:

- ▶ In ServerView Operations Manager *Single System View* select *System Status* from the *Information / Operation* menu.
- ▶ Under *Network Interfaces* select *LAN Teaming*.
- ▶ The *Network Interfaces (Summary)* overview shows all configured LAN teams and their components. Choose a LAN team to display further details:
 - *LAN Team Properties*: Properties of the selected LAN team
 - *LAN Team Statistics*: Available statistics about the selected LAN team



For more detailed information, refer to the "ServerView Operations Manager - Server Management" user guide.

5.2.17.1 After replacing / upgrading LAN controllers

Please note when re-using a replaced LAN controller:

- ▶ Confirm with the customer whether the LAN controller you have replaced has been used as part of a LAN teaming configuration.
- ▶ If LAN teaming has been active, you will need to restore the configuration using the LAN driver utility after replacing the LAN controller.

Ensure that the controllers have been assigned as primary or secondary according to your requirements.



For details, refer to the relevant LAN driver manual.

5.2.17.2 After replacing the system board

- ▶ Confirm with the customer whether the onboard LAN controller you have replaced has been used as part of a LAN teaming configuration.
- ▶ If LAN teaming has been active, you will need to restore the configuration using the LAN driver utility after replacing the system board.



For details, refer to the relevant LAN driver manual.

5.2.18 Switching off the ID indicator

Press the ID button on the front panel or use ServerView Operations Manager to switch off the ID indicator after the maintenance task has been concluded successfully.



For further information, refer to section "[Locating the defective server](#)" on [page 47](#) or to the "ServerView Suite Local Service Concept (LSC)" manual.

Using the ID button on the front panel

- ▶ Press the ID button on the front panel to switch off the ID indicators.

Using ServerView Operations Manager

- ▶ In ServerView Operations Manager *Single System View* and press the *Locate* button in the title bar to switch off the ID indicator.

5.2.19 Specifying the chassis model

In order to have your server displayed correctly as a rack system in the ServerView management user interface after a chassis conversion, the chassis model setting needs to be updated.

This can be accomplished using the ServerView Installation Manager or Maintenance Tools:

Using the ServerView Installation Manager

- ▶ Boot the system from the ServerView Suite DVD 1. The ServerView Installation Manager is being started.
- ▶ Select your preferred user interface language.
- ▶ Under *Status backup media* select *No status backup* and click *Continue*.
- ▶ Select *Maintenance*.
- ▶ Select *Server Configuration Manager*.
- ▶ Check the box for rack model and save the setting by clicking *Save*.

Using the ServerView Maintenance Tools

On Windows-based servers with ServerView agents installed, proceed as follows:

- ▶ Click *Start*, point to *All Programs*, and then point to *Fujitsu - ServerView Suite - Agents - Maintenance Tools*.
- ▶ In the *Maintenance Tools* menu pane, click the *Chassis Model Configuration* tab.
- ▶ Under *Convert* to click the *Rack Model* button.
- ▶ Click *Exit* to close the *Maintenance Tools* menu pane.



For more detailed information on installing ServerView agents, refer to the "ServerView Operations Manager - Installation ServerView Agents for Windows" user guide.

6 Power supply units

Safety notes



CAUTION!

- Do not disassemble the power supply unit. Doing so may cause electric shock.
- Areas around the power supply unit may remain extremely hot after shutdown. After shutting down the server, wait for hot components to cool down before removing the power supply unit.
- When installing a power supply unit, ensure that the connector of the power supply unit is not damaged or bent.
- If the power supply unit is hard to remove, do not pull it out by force.
- The power supply unit is heavy, so handle it carefully. If you drop it by mistake, injuries may result.
- For further safety information, please refer to chapter "[Important information](#)" on page 35.

6.1 Basic information

The PRIMERGY TX150 S8 / TX200 S7 server can be equipped:

- with a standard power supply unit (permanently built-in)

The power supply unit adjusts automatically to any mains voltage in the range of 100 V - 240 V.

- or up to two hot-plug power supply units (slide-in units)

In its basic configuration, the server has one power supply unit that adjusts automatically to any mains voltage in the range of 100 V - 240 V. Besides the power supply unit, a second power supply unit can be installed optionally to serve as a redundant power supply. If one power supply unit fails, the second power supply unit in the redundant configuration ensures operation can continue uninterrupted and the defective power supply unit can be replaced during operation (hot-plug).



CAUTION!

The server supports a mains voltage in the range of 100 VAC to 240 VAC. You may only operate the server if its rated voltage range corresponds to the local mains voltage.

6.1.1 Power supply unit configurations

Depending on the server model, the following power supply unit configurations are possible:

	Standard PSU		Hot-plug PSU	
	800 W	500 W	max 2x 800 W	max2x 450 W
PRIMERGY TX150 S8		o		o
PRIMERGY TX200 S7	o		o	o



Figure 35: Server with standard PSU



Figure 36: Server with hot-plug PSUs

6.1.2 Assembly rules

- Mixed assembly of 450 W and 800 W hot-plug PSUs is not supported.
- Always install dummy modules into unused PSU bays to comply with applicable EMC regulations and satisfy cooling requirements.

6.2 Standard power supply

6.2.1 Basic information

There are two different power supply units:



Figure 37: Standard power supply unit 500 W and 800 W

- 1 Power supply unit 500 W for the PRIMERGY TX150 S8
- 2 Power supply unit 800 W for the PRIMERGY TX200 S7

6.2.2 Replacing the standard power supply unit



Replacing the standard power supply unit is illustrated by the example of the power supply unit 500 W for the PRIMERGY TX150 S8.



Field Replaceable Unit (FRU)



Hardware: 10 minutes

Tools: Phillips PH2 / (+) No. 2 screw driver

6.2.2.1 Preliminary steps

- ▶ ["Disabling BitLocker functionality" on page 79](#)
- ▶ ["Locating the defective server" on page 47](#)
- ▶ ["Shutting down the server" on page 50](#)
- ▶ ["Disconnecting the server from the mains" on page 50](#)

- ▶ "Getting access to the component" on page 51
- ▶ "Removing the system fan holder" on page 76

6.2.2.2 Disconnecting power cables

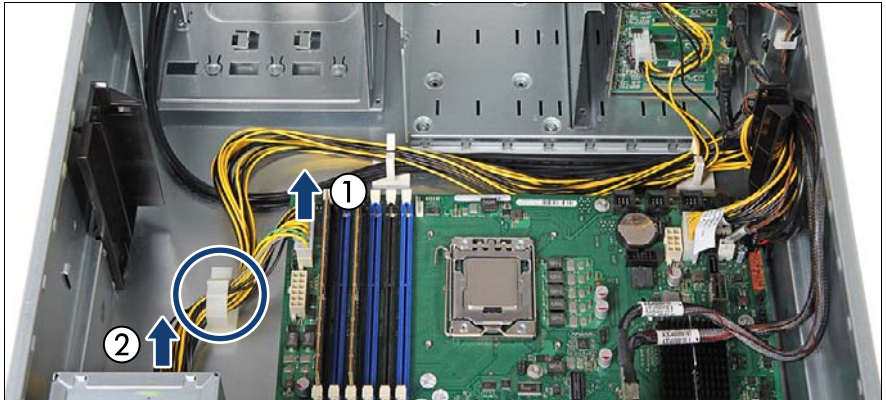

Figure 38: Disconnecting power cables PRIMERGY TX150 S8

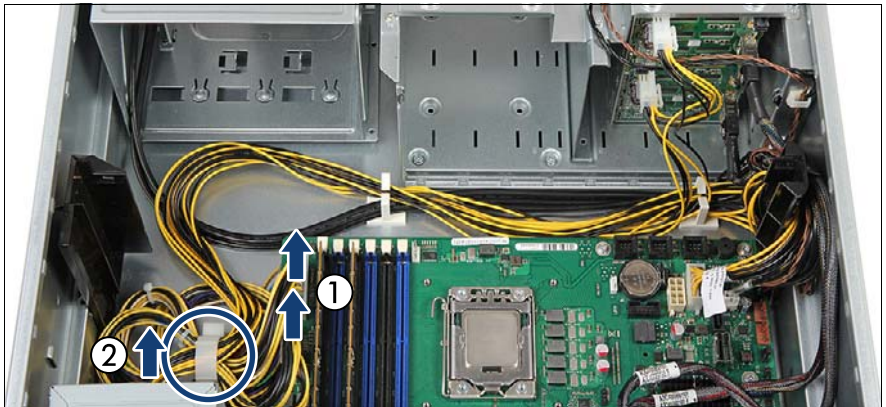

Figure 39: Disconnecting power cables PRIMERGY TX200 S7

- ▶ Open the cable clamp and disconnect the short power cable from the system board (1).
- ▶ Disconnect the long power cable from the connector on the power supply unit (2). The power cable can remain in the cable clamps.
- ▶ Note the position of the power cables.

6.2.2.3 Removing the defective standard power supply unit

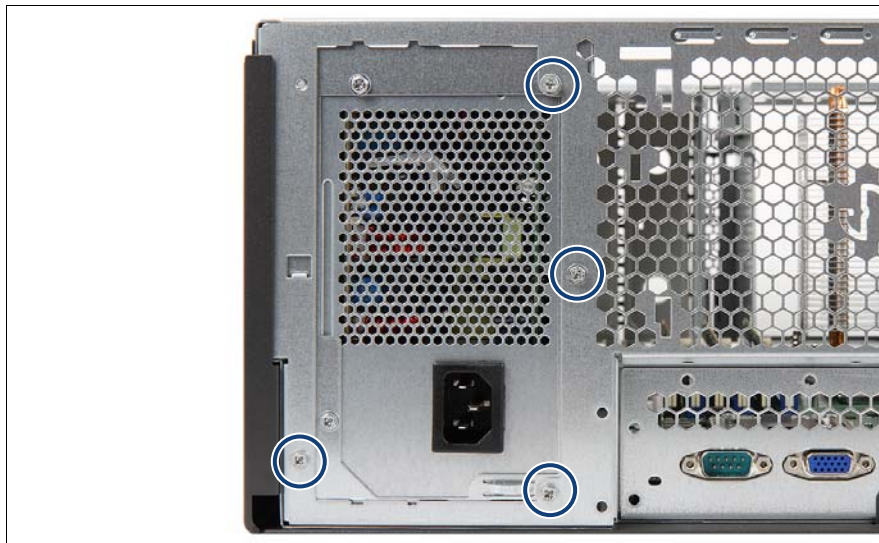

Figure 40: Detaching the standard power supply unit

- ▶ Remove the four screws (see circles).

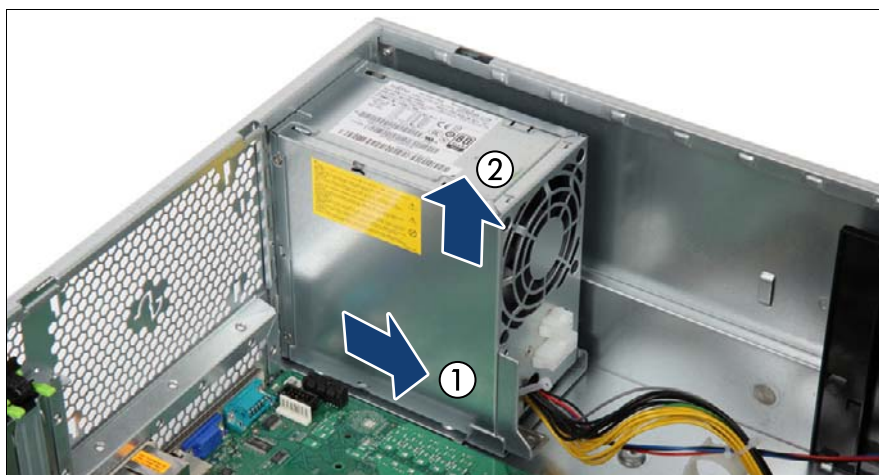

Figure 41: Removing the standard power supply unit

- ▶ Slide the power supply unit inside the chassis by 3 cm (1).

- ▶ Lift the power supply unit out of the chassis (2).



Figure 42: Removing the power supply unit from the installation frame (A)

- ▶ Remove the two screws (see circles).



Figure 43: Removing power supply unit from the installation frame (B)

- ▶ Remove the power supply unit from the installation frame.

6.2.2.4 Installing the new standard power supply unit



Figure 44: Installing PSU in the installation frame (A)

- ▶ Fit the installation frame to the power supply unit.
- ▶ Ensure that the installation frame is correctly seated on the power supply unit.



Figure 45: Installing PSU in the installation frame (B)

- ▶ Secure the installation frame to the power supply unit with two screws (see circles).

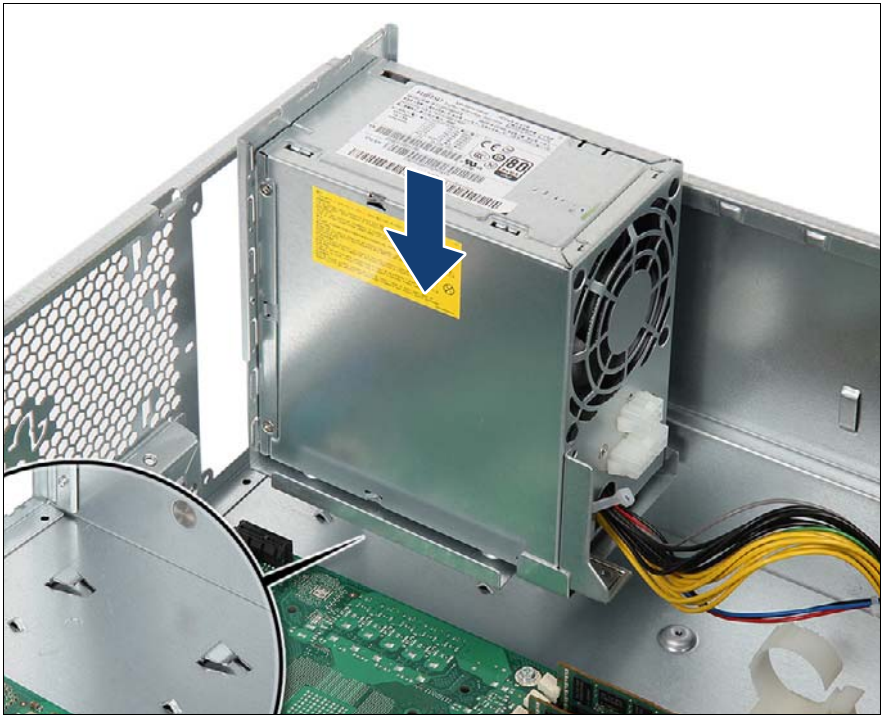

Figure 46: Installing PSU in the chassis (A)

- ▶ Lower the power supply unit into the chassis so that the two hooks on the server floor (see close-up) rest in the recesses in the installation frame.

Power supply units



Figure 47: Installing PSU in the chassis (B)

- ▶ Slide the power supply unit towards the server rear as far as it will go.

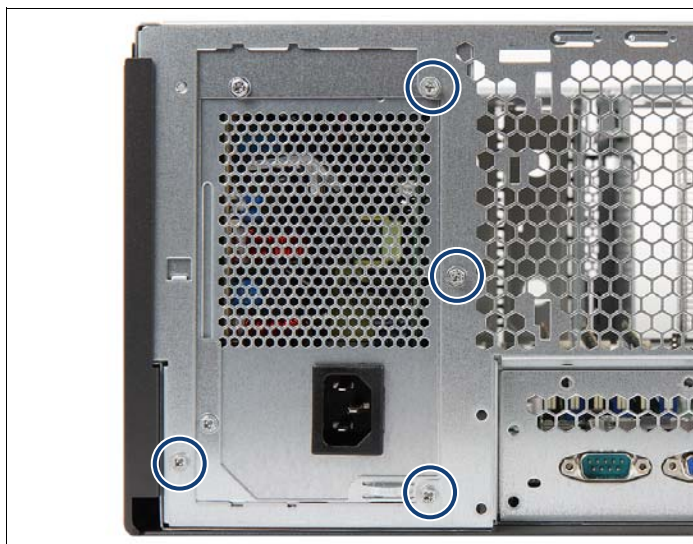

Figure 48: Installing PSU in the chassis (B)

- ▶ Secure the power supply unit to the chassis with four screws (see circles).

6.2.2.5 Connecting power cables

- ▶ Connect the power cables see section ["Cabling plans" on page 403](#).
- ▶ Run the power cable through the cable clamp (see figure [38](#) or figure [39](#)).

6.2.2.6 Concluding steps

- ▶ ["Installing the system fan holder" on page 77](#)
- ▶ ["Reassembling" on page 64](#)
- ▶ ["Connecting the server to the mains" on page 74](#)
- ▶ ["Enabling BitLocker functionality" on page 100](#)

6.3 Redundant power supply

6.3.1 Installing hot-plug power supply units



Customer Replaceable Unit (CRU)



Hardware: 5 minutes

Tools: tool-less

6.3.1.1 Preliminary steps

No steps needed.

6.3.1.2 Removing the PSU dummy cover

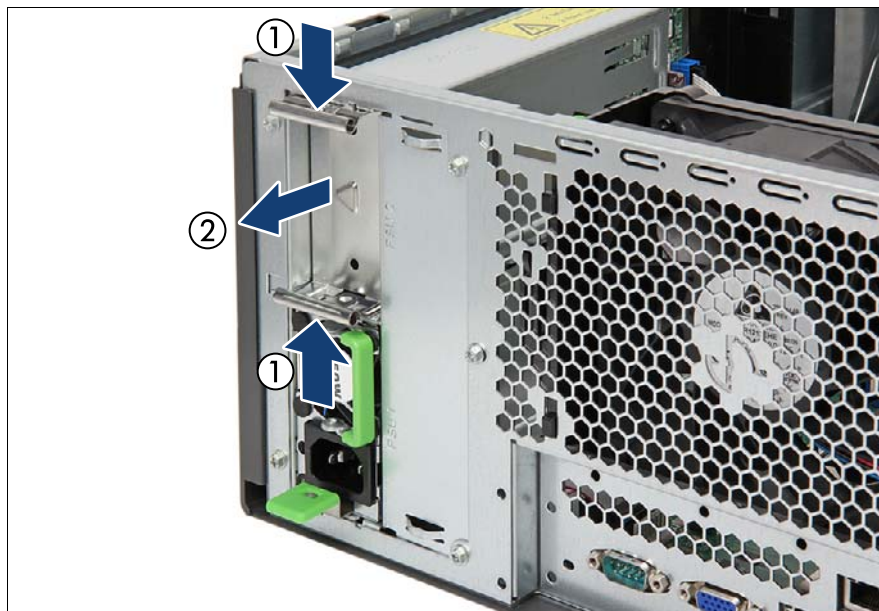

Figure 49: Removing a PSU dummy cover (A)

- ▶ Press in on both release latches (1) and remove the dummy cover (2).

**CAUTION!**

Keep the dummy cover for future use. If a hot-plug PSU is removed and not immediately replaced by a new one, a PSU dummy cover must be reinstalled in the bay to comply with applicable EMC regulations and satisfy cooling requirements.

6.3.1.3 Installing a hot-plug PSU

Figure 50: Installing a hot-plug PSU

- ▶ Push the hot-plug PSU into its bay (1) as far as it will go until the release latch snaps in place (A).
- ▶ If applicable, fold down the handle on the hot-plug PSU.

6.3.1.4 Concluding steps

- ▶ ["Connecting the server to the mains" on page 74](#)

6.3.2 Removing a hot-plug PSU



Customer Replaceable Unit (CRU)



Hardware: 5 minutes

Tools: tool-less



Note for servers using CMA (Cable Management Arm)

Since the installed CMA is blocking hot-plug PSUs, additional steps are required in order to remove or replace a hot-plug PSU:

- ▶ Unlock the CMA stopper.
- ▶ Remove the CMA stopper with the mounted crossbar.
- ▶ Support the CMA stopper, the crossbar and the CMA including cables with your right hand.
- ▶ Remove the hot-plug PSU and install a PSU dummy cover into the empty bay.
- ▶ Remount the complete assembly (CMA stopper, crossbar and CMA) into the rail.

6.3.2.1 Preliminary steps

No steps needed.

6.3.2.2 Removing a hot-plug PSU



Figure 51: Removing a hot-plug PSU

- ▶ Fold up the handle on the hot-plug PSU (1).
- ▶ Press in on the green release latch (2).
- ▶ While keeping the green release latch pressed, pull the hot-plug PSU out of its bay (3).

6.3.2.3 Installing a PSU dummy cover



Figure 52: Installing a PSU dummy cover

- ▶ Insert the PSU dummy cover into the empty PSU bay with the impressed arrow symbol facing to the left (see circle).
- ▶ Push the PSU dummy cover into its bay until it locks in place.



CAUTION!

Always install dummy covers into unused PSU bays to comply with applicable EMC regulations and satisfy cooling requirements.

6.3.3 Replacing a hot-plug PSU



Customer Replaceable Unit (CRU)



Hardware: 5 minutes

Tools: tool-less



CAUTION!

- When replacing a hot-plug PSU in a non-redundant PSU configuration, the server must be switched off first.
- Ensure to replace a defective hot-plug PSU by a new module of the same type.



Note for servers using CMA (Cable Management Arm)

Since the installed CMA is blocking hot-plug PSUs, additional steps are required in order to remove or replace a hot-plug PSU:

- ▶ Unlock the CMA stopper.
- ▶ Remove the CMA stopper with the mounted crossbar.
- ▶ Support the CMA stopper, the crossbar and the CMA including cables with your right hand.
- ▶ Remove the hot-plug PSU and carefully install a new hot-plug PSU.
- ▶ Remount the complete assembly (CMA stopper, crossbar and CMA) into the rail.

6.3.3.1 Preliminary steps

- ▶ ["Locating the defective server" on page 47](#)
- ▶ Only when replacing a power supply module in a non-redundant configuration: ["Disconnecting the server from the mains" on page 50](#)

6.3.3.2 Removing the defective hot-plug PSU

- ▶ Identify the defective hot-plug PSU using the server management software.
- ▶ Remove the hot-plug PSU as described in ["Removing a hot-plug PSU" on page 121](#).

6.3.3.3 Installing the new hot-plug PSU

- ▶ Install the hot-plug PSU as described in ["Installing a hot-plug PSU" on page 119](#).

6.3.3.4 Concluding steps

- ▶ Connect the power cord to the new hot-plug PSU and secure it with a cable tie as described in section ["Connecting the server to the mains" on page 74](#).
- ▶ Only when replacing a hot-plug PSU in a non-redundant configuration: ["Switching on the server" on page 75](#).
- ▶ For the Japanese market: after replacing the hot-plug PSU, it is necessary to execute a fan test. Follow the instructions provided separately.

6.3.4 Replacing the power backplane



Field Replaceable Unit (FRU)



Hardware: 15 minutes

Tools: tool-less

6.3.4.1 Preliminary steps

- ▶ ["Locating the defective server" on page 47](#)
- ▶ ["Shutting down the server" on page 50](#)
- ▶ ["Disconnecting the server from the mains" on page 50](#)
- ▶ ["Getting access to the component" on page 51](#)
- ▶ ["Removing the system fan holder" on page 76](#)

6.3.4.2 Removing the hot-plug PSUs

- ▶ Remove all hot-plug PSUs as described in ["Removing a hot-plug PSU" on page 121](#).

6.3.4.3 Replacing the defective power backplane

- ▶ Disconnect all cables from the power backplane.

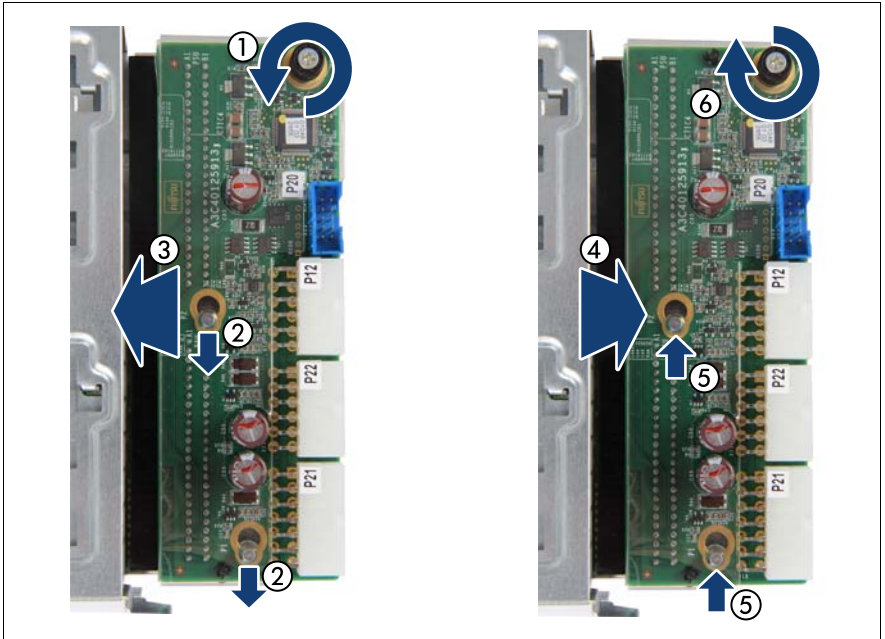

Figure 53: Replacing the power backplane

- ▶ Loosen the captive screw (1).
- ▶ Push the power backplane in direction of the arrow (2).
- ▶ Remove the power backplane (3).
- ▶ Insert the new power backplane in the PSU cage (4).
- ▶ Push the power backplane in direction of the arrow (5).
- ▶ Fasten the captive screw (6).

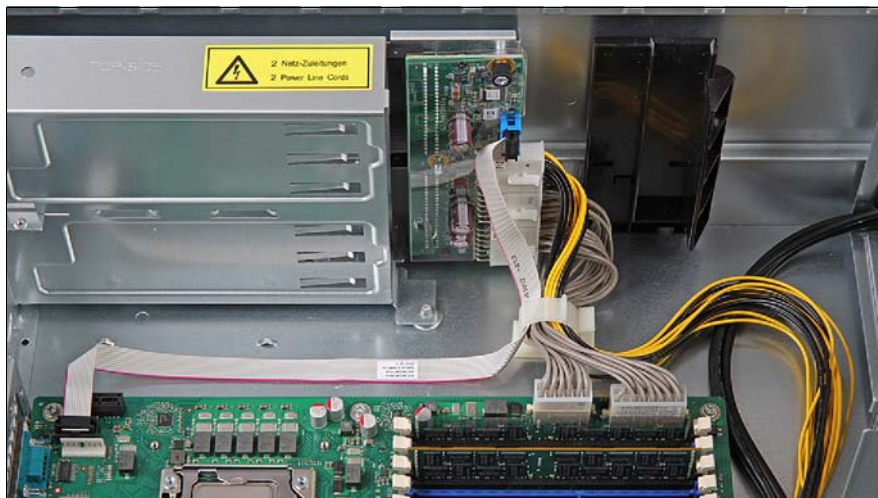

Figure 54: Reconnecting all cables to the power backplane

- ▶ Reconnect all cables to the power backplane.

6.3.4.4 Concluding steps

- ▶ ["Installing the system fan holder" on page 77](#)
- ▶ ["Reassembling" on page 64](#)
- ▶ ["Connecting the server to the mains" on page 74](#)
- ▶ ["Switching on the server" on page 75](#)

6.4 Converting a standard power supply to a redundant power supply

The standard power supply can be replaced by a redundant power supply. The redundant power supply consists of up to two hot-plug PSUs. The upgrade kit contains only one hot-plug PSU (for power supply redundancy the second hot-plug PSU must be additionally ordered).

The upgrade kit for the redundant power supply consists of the following parts:

- PSU cage with power backplane (incl. power cables)
- one hot-plug PSU
- PSU dummy cover (if only one hot-plug PSU is installed, you have to install the PSU dummy cover in the second bay)
- several screws



Field Replaceable Unit (FRU)



Hardware: 15 minutes

Tools: Phillips PH2 / (+) No. 2 screw driver

6.4.1 Preliminary steps

- ▶ ["Disabling BitLocker functionality" on page 79](#)
- ▶ ["Shutting down the server" on page 50](#)
- ▶ ["Disconnecting the server from the mains" on page 50](#)
- ▶ ["Getting access to the component" on page 51](#)
- ▶ ["Removing the system fan holder" on page 76](#)

6.4.2 Removing the standard power supply unit

- ▶ Disconnect the power cables as described in section ["Disconnecting power cables" on page 111](#).
- ▶ Remove the standard PSU as described in section ["Removing the defective standard power supply unit" on page 112](#).

6.4.3 Installing the hot-plug power supply units

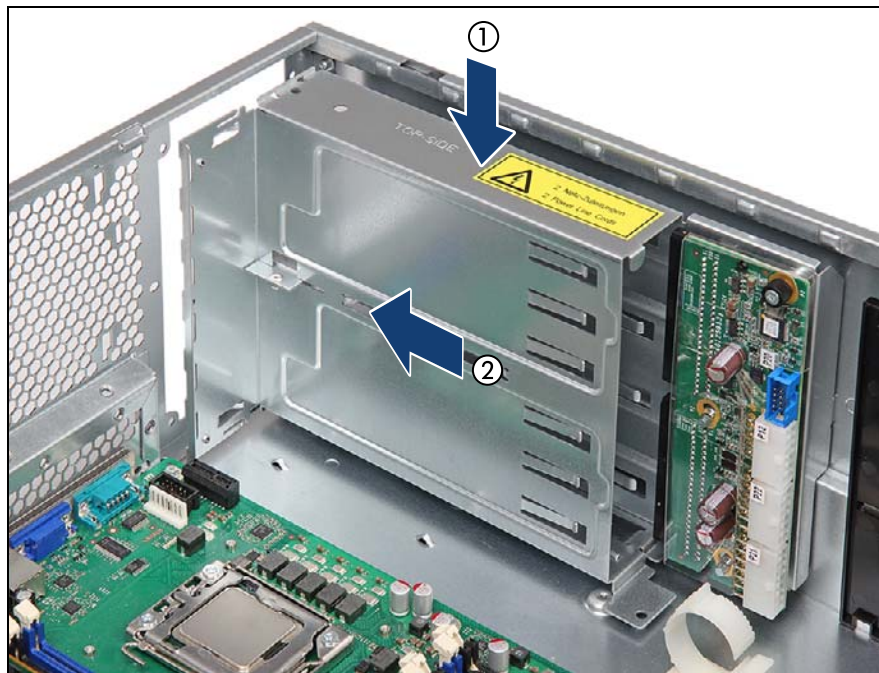

Figure 55: Installing the PSU cage

- ▶ Insert the PSU cage into the chassis (1).
- ▶ Slide the new PSU cage towards the rear of the chassis (2).



Figure 56: Securing the PSU cage (A)

- ▶ Secure the PSU cage with one screw (see circle).

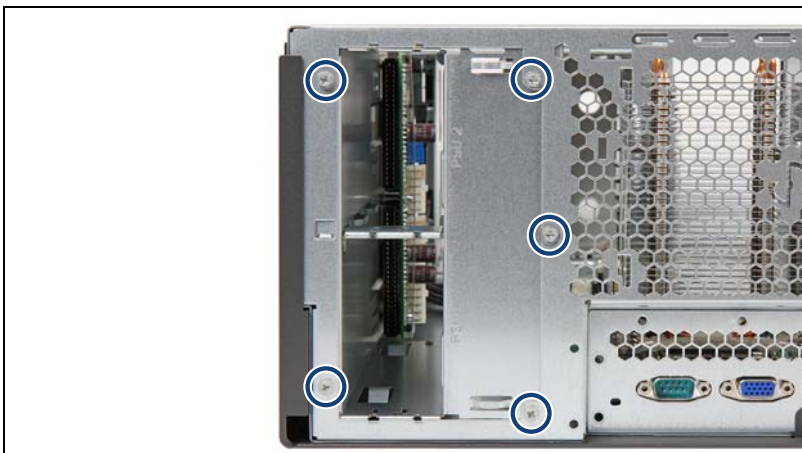

Figure 57: Securing the PSU cage (B)

- ▶ Secure the PSU cage to the chassis with five screws (see circles).



Figure 58: Connecting cables (A)

- ▶ Connect the power cable (1):
 - connector P22 to power backplane connector "P22"
 - connector P1 to system board connector "PWR 1"
- ▶ Connect power cable (2):
 - connector P21 to power backplane connector "P21" (TX200 S7)
 - connector P2 to system board connector "PWR 2" (TX200 S7)

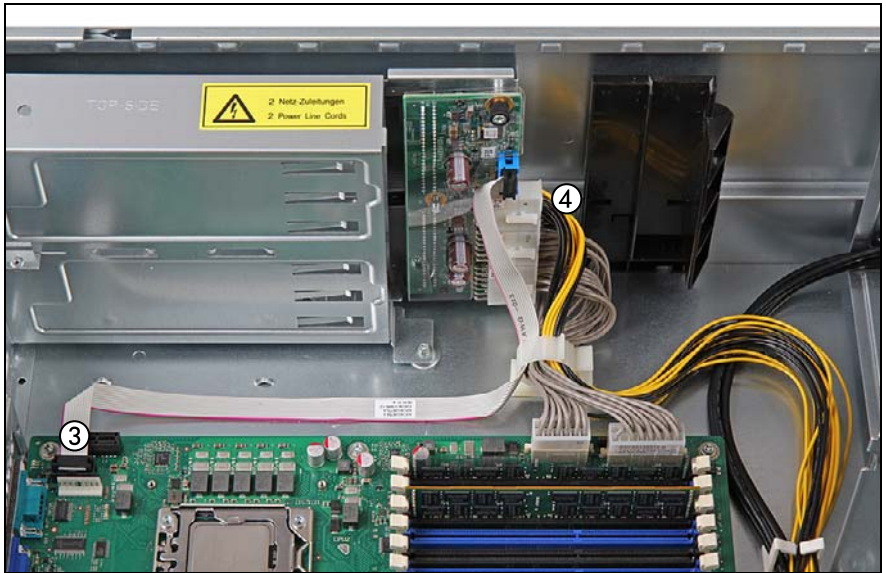

Figure 59: Connecting cables (B)

- ▶ Connect the signal cable (3):
 - connector P20 to power backplane connector "P20"
 - connector P30 to system board connector "P30"
- ▶ Connect the power cable (4):
 - connector P12 (12-pin) to power backplane connector "P12"

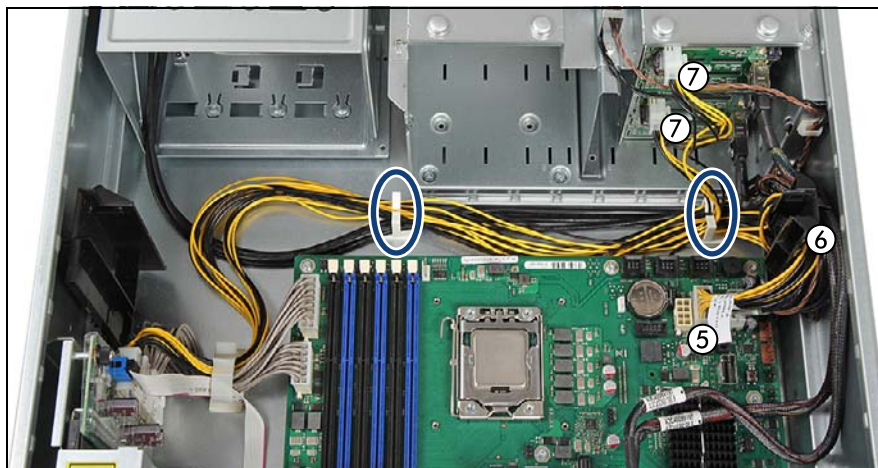

Figure 60: Connecting cables (C)

- ▶ Connect the power cable (4 in figure 59) to the system board and the SAS backplane:
 - connector P12 (10-pin) to system board connector "P3(PWR3)" (5)
 - Run the cable through the cable guide (6) as shown.
 - 2.5-inch HDD configurations (7): see section ["Cabling plans" on page 403](#)
 - 3.5-inch HDD configurations (7): see section ["Cabling plans" on page 403](#)
- ▶ Run the cable through the two cable clamps (see circles).

**CAUTION!**

Installed LTO drive: ensure that the power cables are routed under the cant of the LTO drive and have no contact with the LTO drive.

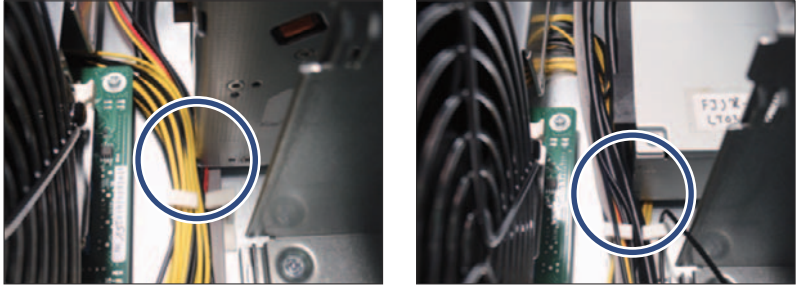

Figure 61: Routing power cables with installed LTO drive

- ▶ Install the hot-plug PSU(s) as described in ["Installing a hot-plug PSU" on page 119](#).
- ▶ If one of the PSU bays remains empty, install the PSU dummy cover as described in ["Installing a PSU dummy cover" on page 122](#).

6.4.4 Concluding steps

- ▶ ["Installing the system fan holder" on page 77](#)
- ▶ ["Reassembling" on page 64](#)
- ▶ ["Connecting the server to the mains" on page 74](#)
- ▶ ["Enabling BitLocker functionality" on page 100](#)

7 Hard disk drives / solid state drives

Safety notes



CAUTION!

- The hard disk drive must not be removed from the installation frame by anyone except a service technician.
- HDD / SSD modules must all be marked clearly so that they can be reinstalled into their original mounting locations after replacement. Otherwise, data may be lost.
- Do not touch the circuitry on boards or soldered parts. Hold the metallic areas or the edges of the circuit boards.
- Before removing a hard disk drive, wait for about 30 seconds until the disk has stopped spinning completely.
- When a hard disk drive is starting up, a resonant noise may be audible for a short while. This does not indicate a failure.
- Depending on the OS, you can configure the write cache settings for the hard disk drives. If a power failure should occur while the write cache is enabled, cached data may be lost.
- When disposing of, transferring, or returning a hard disk or solid state drive, wipe out the data on the drive for your own security.
- Rough handling of hard disk drives may damage the stored data. To cope with any unexpected problems, always back up important data. When backing up data to another hard disk drive, you should make backups on a file or partition basis.
- Handle the device on a shock and vibration free surface.
- Do not use the device in extremely hot or cold locations, or locations with extreme temperature changes.
- Never attempt to disassemble a hard disk or solid state drive.
- For further safety information, please refer to chapter ["Important information"](#) on page 35.

7.1 Basic information

- Solid state drives (SSDs) are always equipped before installing hard disk drives.
- Mixed configurations with Eco SATA drives and SAS drives are not allowed.
- 2.5-inch SAS drives and 2.5-inch BC SATA drives can be mixed, but not used in one logical RAID volume.
- Hot replace is only possible with running RAID.
- Please refer to section ["2.5-inch HDD / SSD configurations" on page 136](#) and section ["3.5-inch HDD configurations" on page 150](#) for a complete overview of the mounting sequences.
- Install dummy modules into unused HDD / SSD bays.

7.2 2.5-inch HDD / SSD configurations

7.2.1 8x 2.5-inch HDD / SSD configuration

7.2.1.1 Mounting order



Figure 62: Mounting order with up to 8 2.5-inch HDDs (2 SAS backplanes)

7.2.1.2 HDD / SSD naming scheme



Figure 63: Naming scheme with 8 2.5-inch HDDs (2 SAS backplanes)

Position	Logical drive number	ServerView RAID Manager display name
①	0	HDD vendor name (0)
②	1	HDD vendor name (1)
③	2	HDD vendor name (2)
④	3	HDD vendor name (3)
⑤	4	HDD vendor name (4)
⑥	5	HDD vendor name (5)
⑦	6	HDD vendor name (6)
⑧	7	HDD vendor name (7)

7.2.2 16x 2.5-inch HDD / SSD configuration



This configuration requires the 8x 2.5-inch HDD extension box (see section "HDD extension boxes" on page 167).

7.2.2.1 Mounting order



Figure 64: Mounting order with up to 16 2.5-inch HDDs (4 SAS backplanes) - Rack version



Figure 65: Mounting order with up to 16 2.5-inch HDDs (4 SAS backplanes) - Tower version

7.2.2.2 HDD / SSD naming scheme



Figure 66: Naming scheme with 16 2.5-inch HDDs (4 SAS backplanes)

With two SAS controllers

Position	Logical drive number	ServerView RAID Manager display name	
1	0	HDD vendor name (0:0)	Ctrl (0)
2	1	HDD vendor name (0:1)	Ctrl (0)
3	2	HDD vendor name (0:2)	Ctrl (0)
4	3	HDD vendor name (0:3)	Ctrl (0)
5	4	HDD vendor name (0:4)	Ctrl (0)
6	5	HDD vendor name (0:5)	Ctrl (0)
7	6	HDD vendor name (0:6)	Ctrl (0)
8	7	HDD vendor name (0:7)	Ctrl (0)
9	0	HDD vendor name (1:0)	Ctrl (1)
10	1	HDD vendor name (1:1)	Ctrl (1)
11	2	HDD vendor name (1:2)	Ctrl (1)
12	3	HDD vendor name (1:3)	Ctrl (1)
13	4	HDD vendor name (1:4)	Ctrl (1)
14	5	HDD vendor name (1:5)	Ctrl (1)
15	6	HDD vendor name (1:6)	Ctrl (1)
16	7	HDD vendor name (1:7)	Ctrl (1)

7.2.3 Installing 2.5-inch HDD / SSD modules



Customer Replaceable Unit (CRU)



Hardware: 5 minutes

Tools: tool-less

7.2.3.1 Preliminary steps

- ▶ ["Removing accessible drive and HDD bay covers" on page 60](#)
- ▶ Locate the correct drive bay as described in section ["2.5-inch HDD / SSD configurations" on page 136](#).

7.2.3.2 Removing a 2.5-inch HDD / SSD dummy module

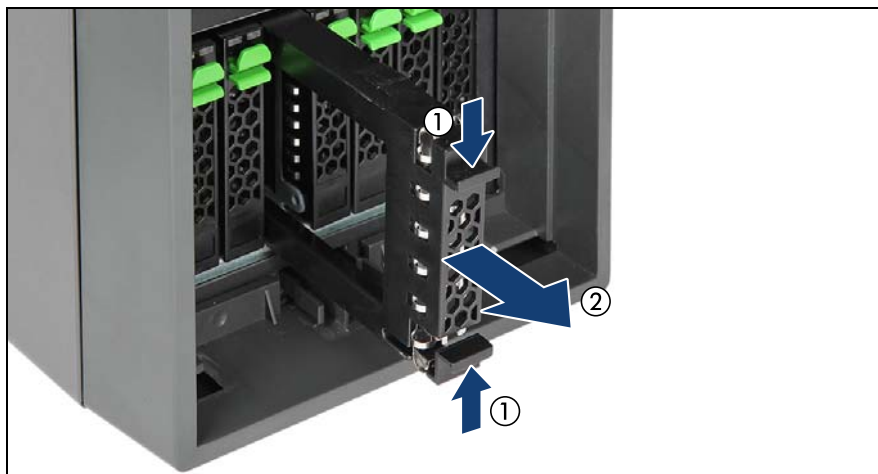

Figure 67: Removing a 2.5-inch dummy module

- ▶ Press both tabs together (1) and pull the dummy module out of its bay (2).



CAUTION!

Save the dummy module for future use.
Always replace dummy modules into unused HDD / SSD bays to comply with applicable EMC regulations and satisfy cooling requirements.

7.2.3.3 Installing a 2.5-inch HDD / SSD module



Figure 68: Opening the 2.5-inch HDD / SSD module locking lever

- ▶ Pinch the green locking clips (1) and open the locking lever (2).



Figure 69: Inserting the 2.5-inch HDD / SSD module

- ▶ Insert the HDD / SSD module into a drive bay and carefully push back as far as it will go.
- ▶ Close the locking lever to lock the hard disk drive in place.

7.2.3.4 Concluding steps

- ▶ ["Installing accessible drive and HDD bay covers" on page 71](#)
- ▶ ["Performing a RAID array rebuild" on page 101](#)

7.2.4 Removing 2.5-inch HDD / SSD modules



Customer Replaceable Unit (CRU)





Hardware: 5 minutes

Tools: tool-less

7.2.4.1 Preliminary steps

- ▶ If the HDD / SSD module to be removed is combined into a RAID array, please proceed as follows:

RAID level	Procedure
RAID 0	<p>Only remove an HDD module combined in a RAID 0 array if defective.</p> <p> CAUTION! Removing an operational HDD module will result in data loss!</p>
RAID 1 RAID 5	<p>Removing an HDD module from a RAID 1 or RAID 5 array will not result in data loss.</p> <p>However, the removed drive needs to be replaced immediately by an HDD module of the same or larger capacity.</p> <p> After replacing the HDD module, RAID rebuild will be performed as a background process as described in section "Performing a RAID array rebuild" on page 101.</p>

In order to permanently remove an operational HDD module that is part of a RAID array from the server, you first need to delete the array using ServerView RAID Manager.



CAUTION!

All data on all HDDs / SSDs in the array will be lost! Be sure to back up your data before deleting a RAID array.

Hard disk drives / solid state drives

For further information, please refer to the "ServerView Suite RAID Management" user guide.

- ▶ ["Removing accessible drive and HDD bay covers" on page 60](#)

7.2.4.2 Removing a 2.5-inch HDD / SSD module



Figure 70: Removing a 2.5-inch HDD / SSD module

- ▶ Pinch the green locking clips and fully open the locking lever (see figure 68).
- ▶ Wait about 30 seconds to allow the hard disk drive to spin down.
 - i** This is not necessary when removing a solid state drive.
- ▶ Pull the HDD / SSD module completely out of its bay.

7.2.4.3 Installing a 2.5-inch HDD / SSD dummy module



CAUTION!

If the removed HDD / SSD module is not replaced immediately, always replace a dummy module into the unused HDD / SSD bay to comply with applicable EMC regulations and satisfy cooling requirements.



Figure 71: Installing a 2.5-inch HDD / SSD dummy module

- ▶ Slide the HDD dummy module into the drive bay until it locks in place.

7.2.4.4 Concluding steps

- ▶ ["Installing accessible drive and HDD bay covers" on page 71](#)

7.2.5 Replacing a 2.5-inch HDD / SSD module



Customer Replaceable Unit (CRU)



Hardware: 5 minutes

Tools: tool-less



CAUTION!

- Only remove an HDD / SSD module during operation if the drive is not currently being accessed. Observe the indicators on the HDD / SSD module, as described in the "PRIMERGY TX150 S8 / TX200 S7 Server" operating manual".
- Under no circumstances should you remove an HDD / SSD module while the system is in operation if you are not sure that the drive is operated by a RAID controller and belongs to a disk array that is operating in RAID level 1, 1E, 10, 5, 50, 6 or 60.

An HDD / SSD module can only be replaced during operation in conjunction with a corresponding RAID configuration.

- All HDD / SSD modules (drives) must be uniquely identified so that they can be reinstalled in their original mounting locations later. If this is not done, existing data can be lost.

7.2.5.1 Preliminary steps

- ▶ ["Locating the defective server" on page 47](#)
- ▶ ["Removing accessible drive and HDD bay covers" on page 60](#)
- ▶ Locate the defective HDD / SSD module as described in section ["Local diagnostic indicators on the front" on page 49](#).

Only applicable for removing intact HDD / SSD modules:

- ▶ Before removing a non-defective HDD / SSD module, put the drive into "Offline" mode using your RAID configuration software.

7.2.5.2 Removing a 2.5-inch HDD / SSD module

- ▶ Remove the HDD / SSD module to be replaced from the server as described in section ["Removing a 2.5-inch HDD / SSD module" on page 144](#).

7.2.5.3 Installing a 2.5-inch HDD / SSD module

- ▶ Install the new HDD / SSD module into the empty drive bay as described in section ["Installing 2.5-inch HDD / SSD modules" on page 140](#).

7.2.5.4 Concluding steps

- ▶ ["Installing accessible drive and HDD bay covers" on page 71](#)
- ▶ ["Performing a RAID array rebuild" on page 101](#)

7.2.6 Replacing a 2.5-inch HDD SAS backplane



Upgrade and Repair Unit (URU)



Hardware: 15 minutes

Tools: Phillips PH2 / (+) No. 2 screw driver

7.2.6.1 Preliminary steps

- ▶ ["Shutting down the server" on page 50](#)
- ▶ ["Disconnecting the server from the mains" on page 50](#)
- ▶ ["Getting access to the component" on page 51](#)
- ▶ ["Removing the system fan holder" on page 76](#)
- ▶ ["Removing 2.5-inch HDD / SSD modules" on page 143](#)

7.2.6.2 Removing the defective SAS backplane

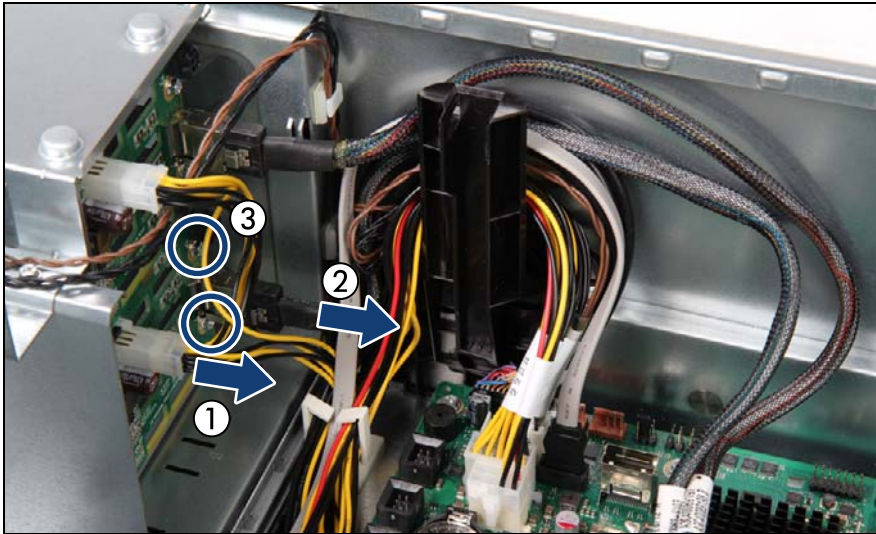

Figure 72: Disconnecting cables

- ▶ Disconnect the power cable (1) and the SAS cable (2) from the SAS backplane.
- ▶ Remove the two screws (3, see circles).

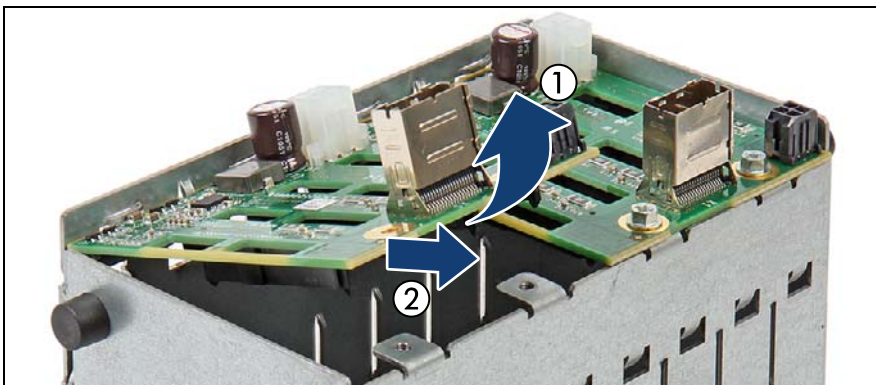

Figure 73: Removing the 2.5-inch HDD SAS backplane

- ▶ Lift up the SAS backplane (1) and at a slight angle, remove it from the guides on the HDD cage (2).

7.2.6.3 Installing the new SAS backplane

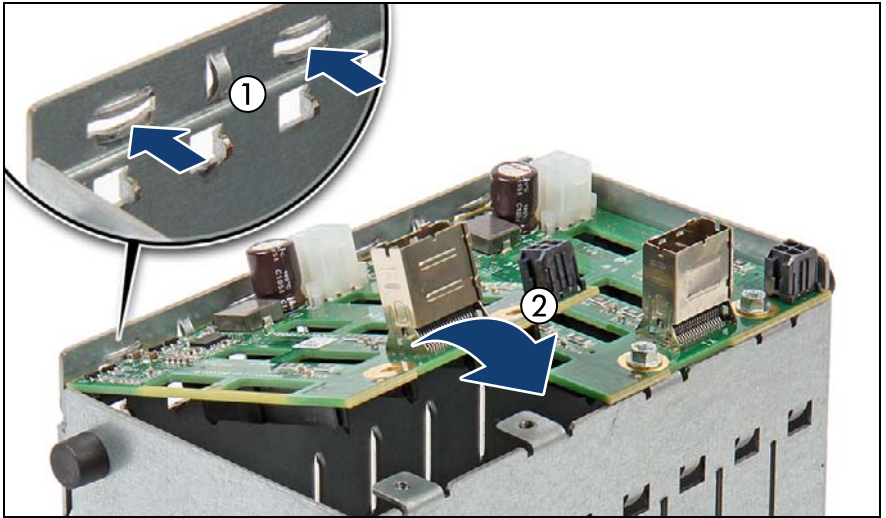

Figure 74: Installing the 2.5-inch HDD SAS backplane

- ▶ At a slight angle, fit the SAS backplane into the two guides on the HDD cage (1).
- ▶ Fold down the SAS backplane (2).
- ▶ Secure the SAS backplane with the two screws (see figure 72).
- ▶ Connect the power cable and the SAS cable to the SAS backplane (see figure 72).

7.2.6.4 Concluding steps

- ▶ ["Installing the system fan holder" on page 77](#)
- ▶ ["Reassembling" on page 64](#)
- ▶ ["Installing a 2.5-inch HDD / SSD module" on page 141](#) and ["Installing a 2.5-inch HDD / SSD dummy module" on page 145.](#)



For detailed information on HDD mounting order, refer to section ["2.5-inch HDD / SSD configurations" on page 136.](#)

- ▶ ["Connecting the server to the mains" on page 74](#)
- ▶ ["Switching on the server" on page 75](#)

7.3 3.5-inch HDD configurations

7.3.1 4x 3.5-inch HDD configuration

7.3.1.1 Mounting order



Figure 75: Mounting order with up to 4 3.5-inch HDDs (1 SAS backplane)

7.3.1.2 HDD / SSD naming scheme



Figure 76: Naming scheme with 4 3.5-inch HDDs (1 SAS backplane)

Position	Logical drive number	ServerView RAID Manager display name
①	0	HDD vendor name (0)
②	1	HDD vendor name (1)
③	2	HDD vendor name (2)
④	3	HDD vendor name (3)

7.3.2 6x 3.5-inch HDD configuration

i This configuration requires the 2x 3.5-inch HDD extension box (see section "[HDD extension boxes](#)" on page 167).

7.3.2.1 Mounting order



Figure 77: Mounting order with up to 6 3.5-inch HDDs (2 SAS backplanes) - Rack version



Figure 78: Mounting order with up to 6 3.5-inch HDDs (2 SAS backplanes) - Tower version

7.3.2.2 HDD / SSD naming scheme



Figure 79: Naming scheme with 10 3.5-inch HDDs (2 SAS backplanes) - Rack version

Position	Logical drive number	ServerView RAID Manager display name
①	0	HDD vendor name (1:0)
②	1	HDD vendor name (1:1)
③	2	HDD vendor name (1:2)
④	3	HDD vendor name (1:3)
⑤	4	HDD vendor name (1:4)
⑥	5	HDD vendor name (1:5)

7.3.3 8x 3.5-inch HDD configuration

i This configuration requires the 4x 3.5-inch HDD extension box (see section ["HDD extension boxes" on page 167](#)).

7.3.3.1 Mounting order



Figure 80: Mounting order with up to 8 3.5-inch HDDs (2 SAS backplanes) - Rack version



Figure 81: Mounting order with up to 8 3.5-inch HDDs (2 SAS backplanes) - Tower version

7.3.3.2 HDD / SSD naming scheme

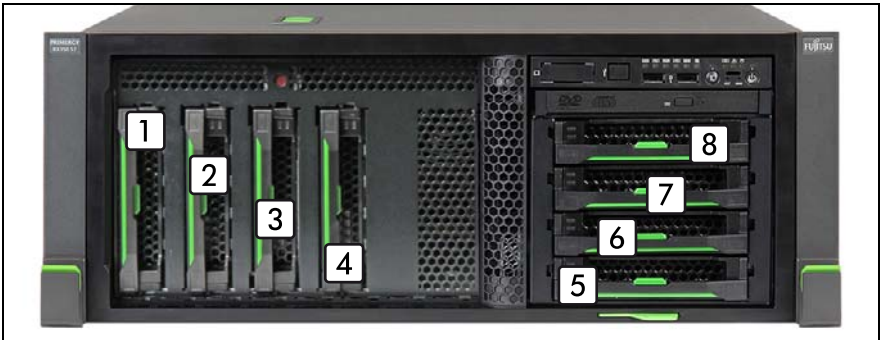

Figure 82: Naming scheme with 8 3.5-inch HDDs (2 SAS backplanes) - Rack version

Position	Logical drive number	ServerView RAID Manager display name
①	0	HDD vendor name (1:0)
②	1	HDD vendor name (1:1)
③	2	HDD vendor name (1:2)
④	3	HDD vendor name (1:3)
⑤	4	HDD vendor name (1:4)
⑥	5	HDD vendor name (1:5)
⑦	6	HDD vendor name (1:6)
⑧	7	HDD vendor name (1:7)

7.3.4 Installing 3.5-inch HDD modules



Customer Replaceable Unit (CRU)



Hardware: 5 minutes

Tools: tool-less

7.3.4.1 Preliminary steps

- ▶ ["Removing accessible drive and HDD bay covers" on page 60](#)
- ▶ Locate the correct drive bay as described in section ["3.5-inch HDD configurations" on page 150](#).

7.3.4.2 Removing a 3.5-inch HDD dummy module

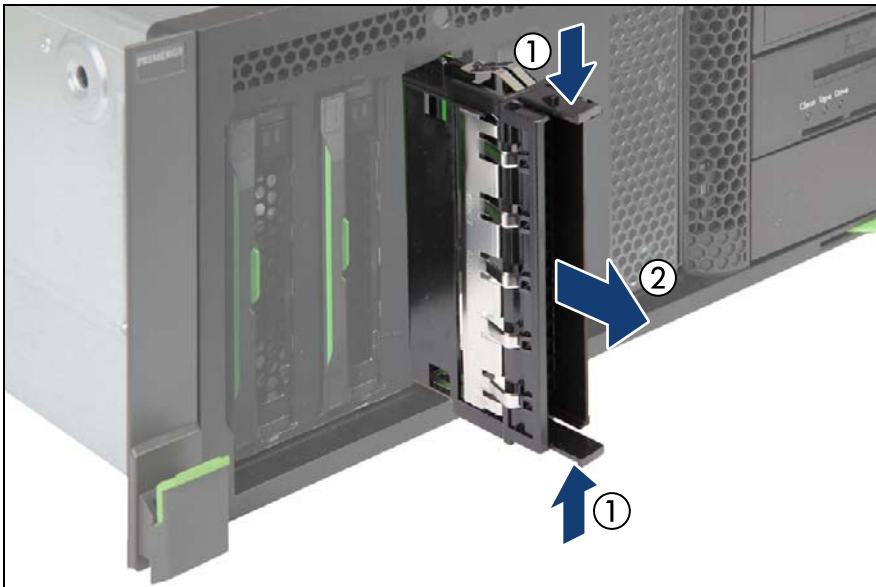

Figure 83: Removing a 3.5-inch dummy module

- ▶ Press in on the locking tabs on both sides of the dummy module to disengage the locking mechanism (1).

- ▶ While keeping the locking tabs pressed, pull the dummy module out of its bay (2).



CAUTION!

Save the dummy module for future use.

Always replace dummy modules into unused HDD bays to comply with applicable EMC regulations and satisfy cooling requirements.

7.3.4.3 Installing a 3.5-inch HDD module



Figure 84: Opening the 3.5-inch HDD module locking lever

- ▶ While pressing down on the locking button (1) fold up the lever (2).



Figure 85: Inserting the 3.5-inch HDD module

- ▶ Insert the HDD module into a drive bay and carefully push back as far as it will go (1).
- ▶ Fold down the lever to lock the HDD module in place (2).

7.3.4.4 Concluding steps

- ▶ ["Installing accessible drive and HDD bay covers" on page 71](#)
- ▶ ["Performing a RAID array rebuild" on page 101](#)

7.3.5 Removing 3.5-inch HDD modules



Customer Replaceable Unit (CRU)





Hardware: 5 minutes

Tools: tool-less

7.3.5.1 Preliminary steps

- ▶ If the HDD / SSD module to be removed is combined into a RAID array, please proceed as follows:

RAID level	Procedure
RAID 0	<p>Only remove an HDD module combined in a RAID 0 array if defective.</p> <p> CAUTION! Removing an operational HDD module will result in data loss!</p>
RAID 1 RAID 5	<p>Removing an HDD module from a RAID 1 or RAID 5 array will not result in data loss.</p> <p>However, the removed drive needs to be replaced immediately by an HDD module of the same or larger capacity.</p> <p> After replacing the HDD module, RAID rebuild will be performed as a background process as described in section "Performing a RAID array rebuild" on page 101.</p>

In order to permanently remove an operational HDD module that is part of a RAID array from the server, you first need to delete the array using ServerView RAID Manager.



CAUTION!

All data on all HDDs / SSDs in the array will be lost! Be sure to back up your data before deleting a RAID array.

For further information, please refer to the "ServerView Suite RAID Management" user guide.

- ▶ ["Removing accessible drive and HDD bay covers" on page 60](#)

7.3.5.2 Removing a 3.5-inch HDD module

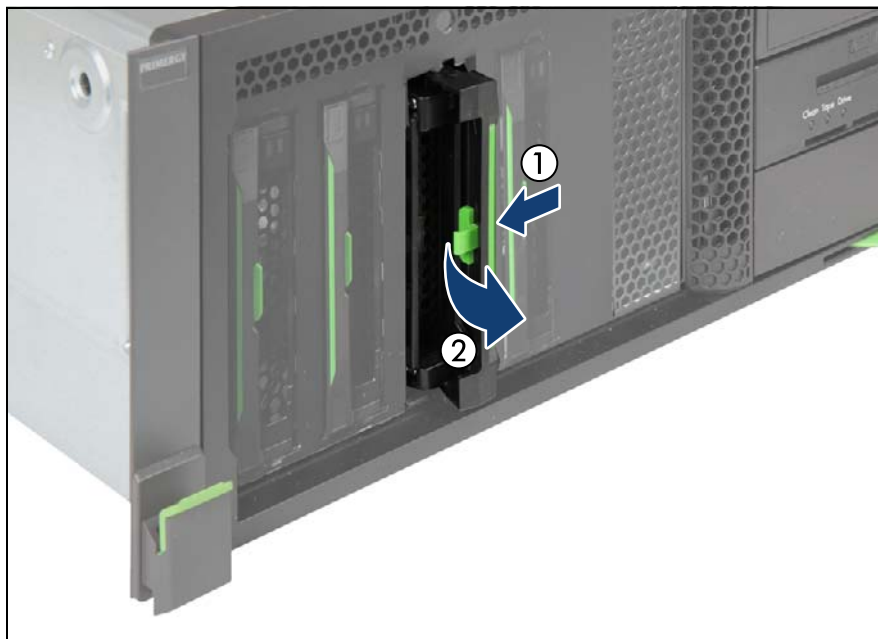

Figure 86: Disconnecting a 3.5-inch HDD module

- ▶ While pressing down on the locking button (1) fold up the lever (2).
 - i** Thereby, the HDD module is pushed out of its drive bay by about 1 cm and disconnected from the SAS / SATA backplane.
- ▶ Wait about 30 seconds to allow the hard disk drive to spin down.
- ▶ Pull the HDD module completely out of its bay.

7.3.5.3 Installing a 3.5-inch HDD dummy module



CAUTION!

If the removed HDD module is not replaced immediately, always replace a dummy module into the unused HDD / SSD bay to comply with applicable EMC regulations and satisfy cooling requirements.

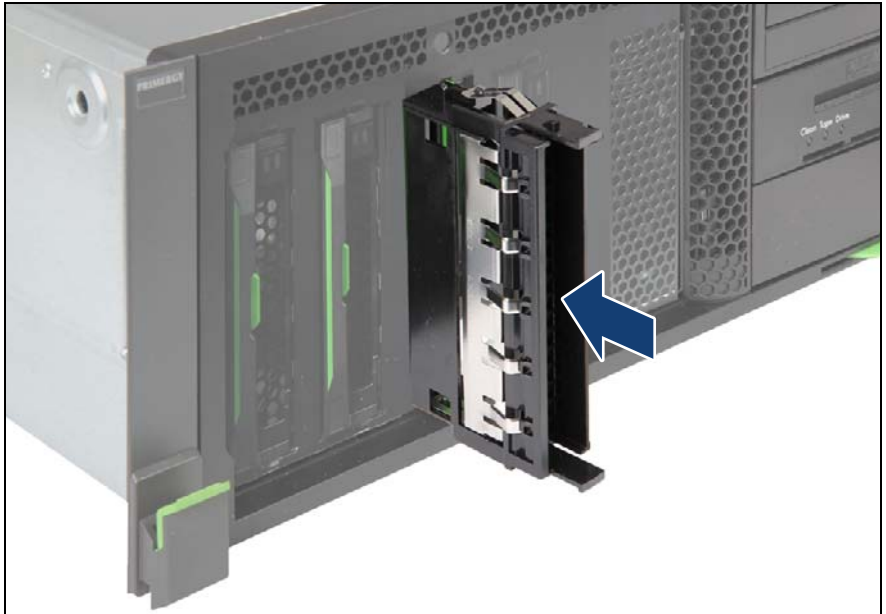

Figure 87: Installing a 3.5-inch HDD dummy module

- ▶ Slide the HDD dummy module into the drive bay until it locks in place.

7.3.5.4 Concluding steps

- ▶ ["Installing accessible drive and HDD bay covers" on page 71](#)

7.3.6 Replacing a 3.5-inch HDD module



Customer Replaceable Unit (CRU)



Hardware: 5 minutes

Tools: tool-less



CAUTION!

- Only remove an HDD / SSD module during operation if the drive is not currently being accessed. Observe the indicators on the HDD module, as described in the "PRIMERGY TX150 S8 / TX200 S7 Server" operating manual.
- Under no circumstances should you remove an HDD / SSD module while the system is in operation if you are not sure that the drive is operated by a RAID controller and belongs to a disk array that is operating in RAID level 1, 1E, 10, 5, 50, 6 or 60.

An HDD / SSD module can only be replaced during operation in conjunction with a corresponding RAID configuration.

- All HDD / SSD modules (drives) must be uniquely identified so that they can be reinstalled in their original mounting locations later. If this is not done, existing data can be lost.

7.3.6.1 Preliminary steps

- ▶ ["Locating the defective server" on page 47](#)
- ▶ ["Removing accessible drive and HDD bay covers" on page 60](#)
- ▶ Locate the defective HDD module as described in section ["Local diagnostic indicators on the front" on page 49](#).

Only applicable for removing intact HDD modules:

- ▶ Before removing a non-defective HDD module, put the drive into "Offline" mode using your RAID configuration software.



For further information, please refer to the "ServerView Suite RAID Management" user guide, available online at <http://manuals.ts.fujitsu.com> (<http://jp.fujitsu.com/platform/server/primergy/manual/> for the Japanese market) or from the ServerView Suite DVD 2 supplied with your PRIMERGY server.

7.3.6.2 Removing a 3.5-inch HDD module

- ▶ Remove the HDD module to be replaced from the server as described in section "[Removing a 3.5-inch HDD module](#)" on page 158.

7.3.6.3 Installing a 3.5-inch HDD module

- ▶ Install the new HDD module into the empty drive bay as described in section "[Installing 3.5-inch HDD modules](#)" on page 154.

7.3.6.4 Concluding steps

- ▶ "[Installing accessible drive and HDD bay covers](#)" on page 71
- ▶ "[Performing a RAID array rebuild](#)" on page 101

7.3.7 Replacing a 3.5-inch HDD SAS backplane



Upgrade and Repair Unit (URU)



Hardware: 15 minutes

Tools: Phillips PH2 / (+) No. 2 screw driver

7.3.7.1 Preliminary steps

- ▶ "[Shutting down the server](#)" on page 50
- ▶ "[Disconnecting the server from the mains](#)" on page 50
- ▶ "[Getting access to the component](#)" on page 51
- ▶ "[Removing the system fan holder](#)" on page 76
- ▶ "[Removing 3.5-inch HDD modules](#)" on page 157

7.3.7.2 Removing the defective 3.5-inch HDD SAS backplane

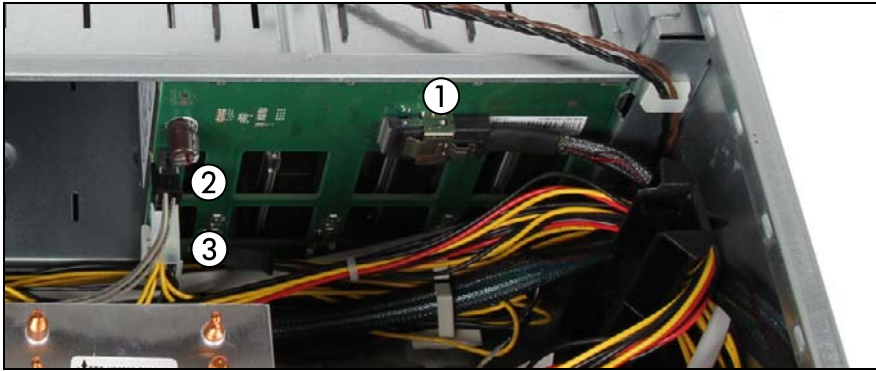

Figure 88: Disconnecting cables

- ▶ Disconnect the cables from the SAS backplane:
 - (1) SAS/SATA data cable from connector "x1"
 - (2) power cable from connector "x9" or "x10" (if applicable)
 - (3) power cable from connector "x7"

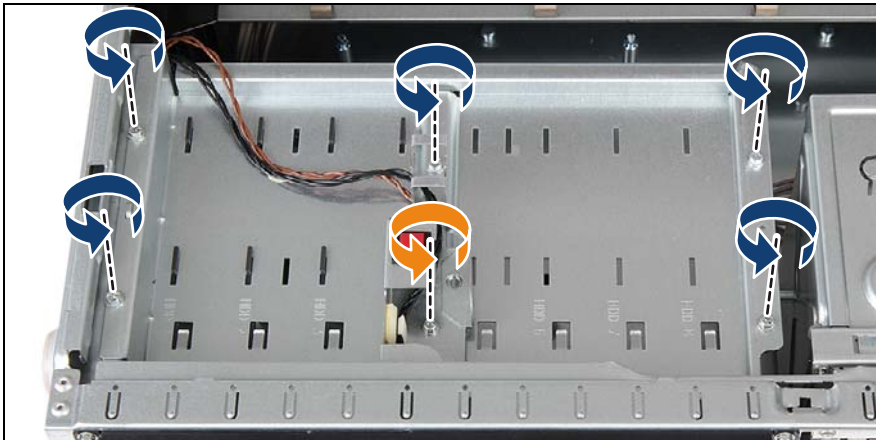

Figure 89: Removing the 3.5-inch HDD bay top cover (A)

- ▶ Remove five screws from the 3.5-inch HDD bay top cover (see blue arrows).
- ▶ Remove one screw from the intrusion switch holder (see orange arrow).

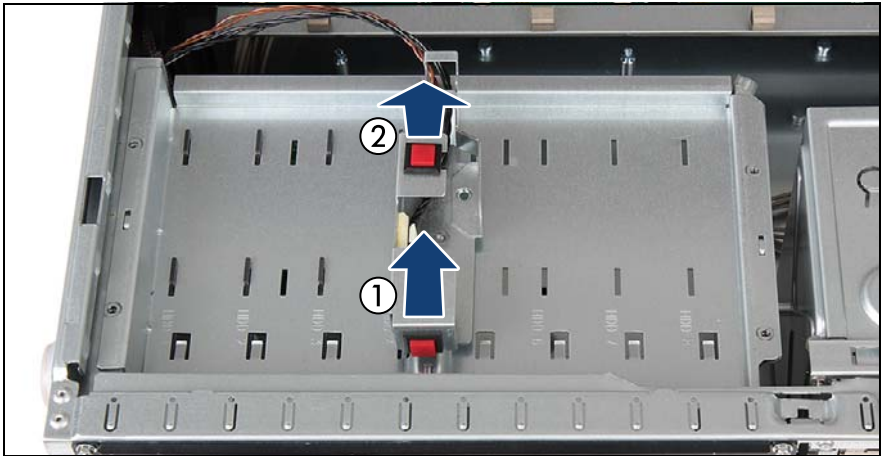

Figure 90: Removing the 3.5-inch HDD bay top cover (B)

- ▶ Slide back the intrusion switch holder until it disengages from the HDD bay top cover (1).
- ▶ Remove the intrusion switch holder (2) and set aside.
- ▶ Leave the intrusion switch cable connected to the system board.

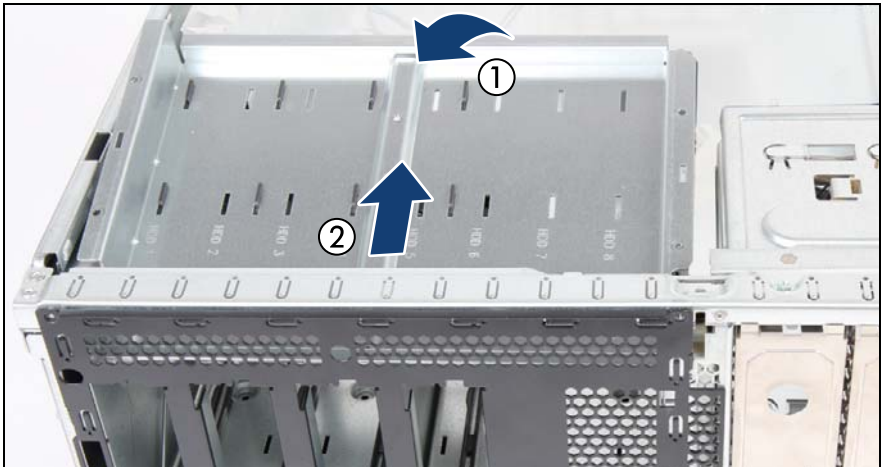

Figure 91: Removing the 3.5-inch HDD bay top cover (C)

- ▶ Carefully fold up the 3.5-inch HDD bay top cover to disengage it from the SAS backplane below (1).

- ▶ Remove the 3.5-inch HDD bay top cover from the chassis (2).

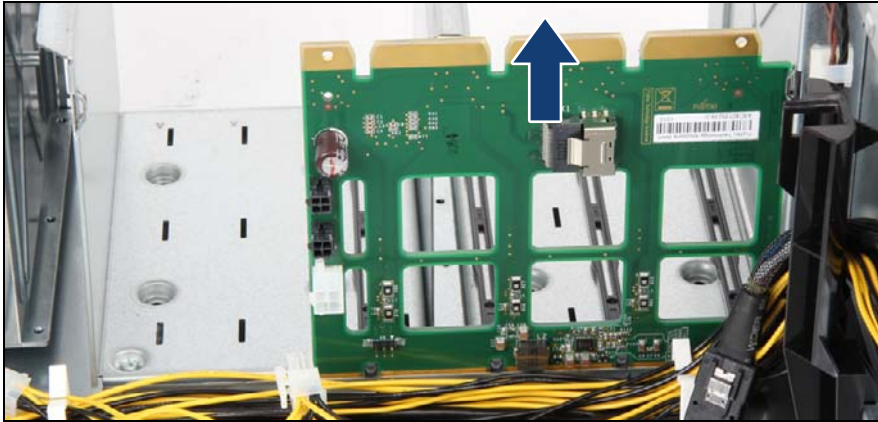

Figure 92: Removing the defective 3.5-inch HDD SAS backplane

- ▶ Pull up on the SAS backplane and remove it from the HDD bay in a vertical motion.

7.3.7.3 Installing the new 3.5-inch HDD SAS backplane

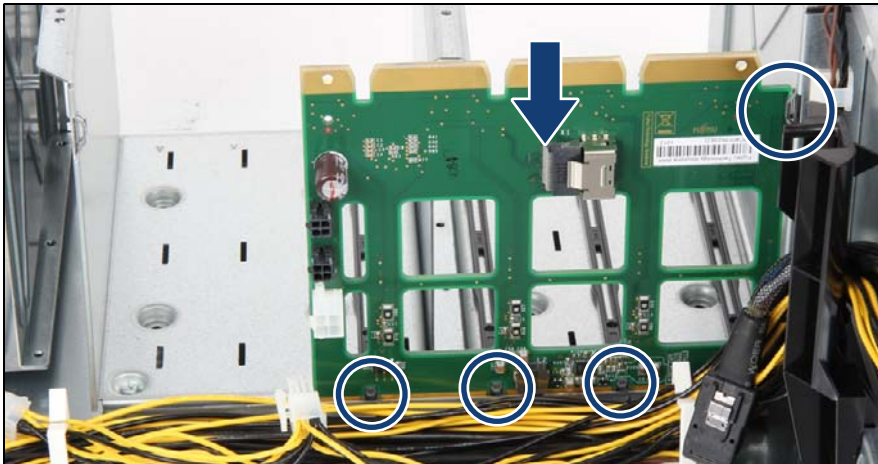

Figure 93: Installing the new 4x 3.5-inch HDD SAS backplane

- ▶ Fit the SAS backplane into the guide on the outer wall of the HDD bay and lower it into the bottom rim.

- ▶ Ensure that the 4x 3.5-inch HDD SAS backplane is properly seated into the bottom rim and side guide (see circles).

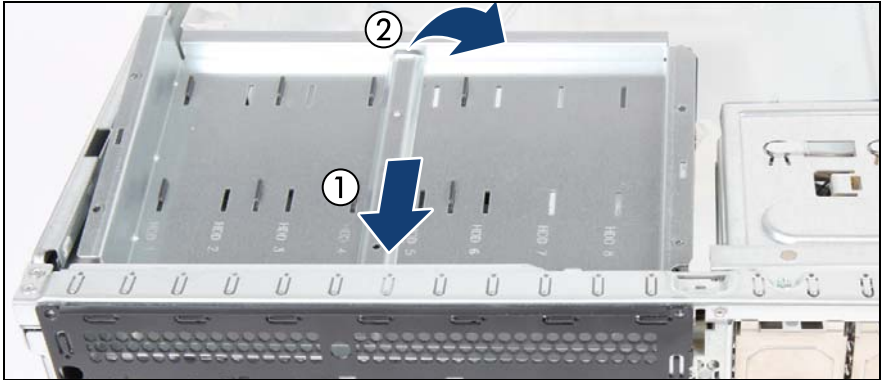

Figure 94: Installing the 3.5-inch HDD bay top cover (A)

- ▶ At a slight angle, fit the HDD bay top cover under the front chassis rim (1).
- ▶ Fold down the HDD bay top cover (2) until it is properly seated on the HDD bays.



CAUTION!

Ensure that the 3.5-inch HDD backplanes is properly secured in the upper rim of the HDD bay top cover.

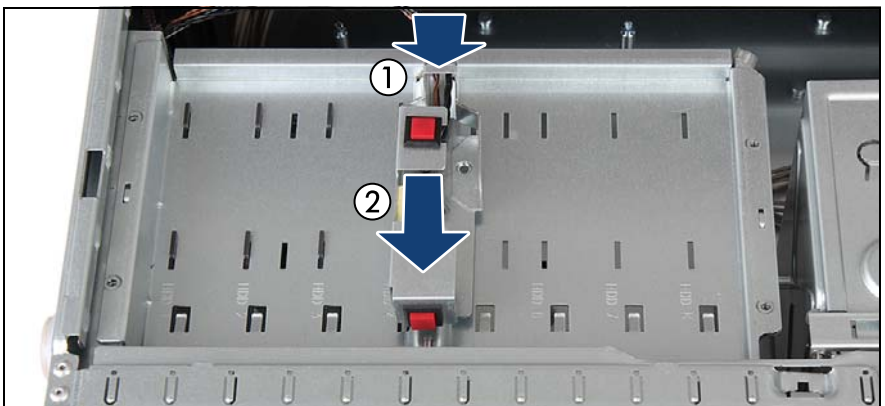

Figure 95: Installing the 3.5-inch HDD bay top cover (B)

- ▶ Place the intrusion switch holder on the HDD bay top cover as shown (1).

- ▶ Slide the intrusion switch holder under the front chassis rim as far as it will go (2).

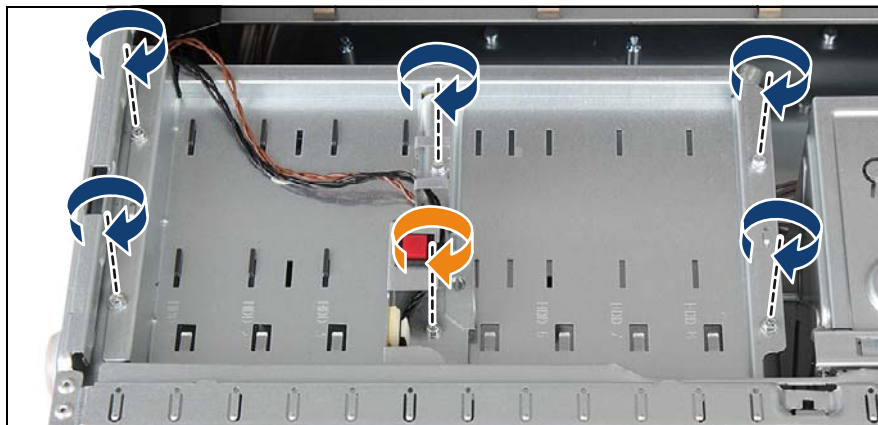

Figure 96: Installing the 3.5-inch HDD bay top cover (C)

- ▶ Secure the HDD bay top cover to the chassis with five screws (see blue arrows).
- ▶ Secure the intrusion switch holder on the HDD bay top cover with one screw (see orange arrow).
- ▶ Connect the cables to the SAS backplane (see figure 88).

7.3.7.4 Concluding steps

- ▶ ["Installing the system fan holder" on page 77](#)
- ▶ ["Reassembling" on page 64](#)
- ▶ ["Connecting the server to the mains" on page 74](#)
- ▶ ["Switching on the server" on page 75](#)
- ▶ ["Installing a 3.5-inch HDD module" on page 155](#) and ["Installing a 3.5-inch HDD dummy module" on page 159.](#)



For detailed information on HDD mounting order, refer to section ["3.5-inch HDD configurations" on page 150.](#)

7.4 HDD extension boxes

i The procedures for the HDD extension boxes are identical except of cabling and required bays.

7.4.1 HDD extension box variants

8x 2.5-inch HDD extension box



Figure 97: 8x 2.5-inch HDD extension box - Rack version

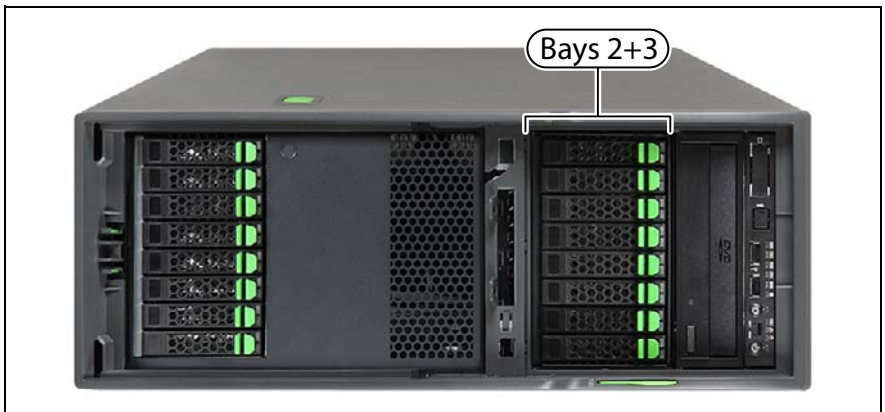

Figure 98: 8x 2.5-inch HDD extension box - Tower version

i The 8x 2.5-inch HDD extension box occupies accessible drive bays 2 and 3.

2x 3.5-inch HDD extension box



Figure 99: 2x 3.5-inch HDD extension box - Rack version



Figure 100: 2x 3.5-inch HDD extension box - Tower version

i The 2x 3.5-inch HDD extension box occupies accessible drive bays 2 and 3. This box can also be equipped with a slimline ODD and/or a LSD module.

4x 3.5-inch HDD extension box



Figure 101: 4x 3.5-inch HDD extension box - Rack version

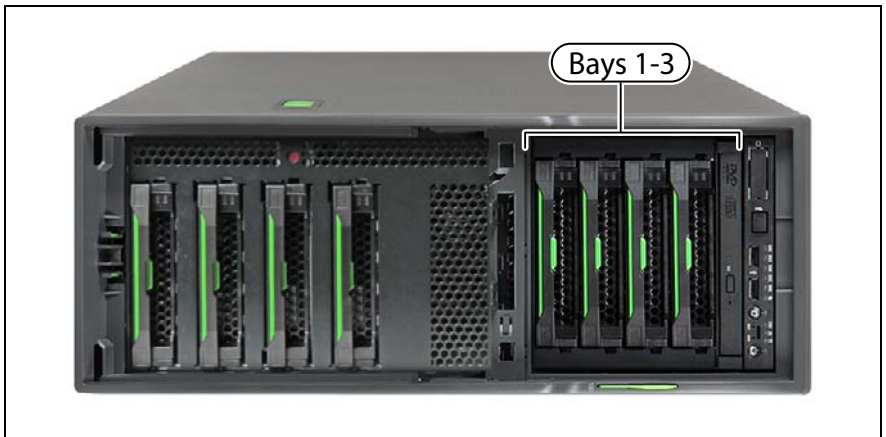

Figure 102: 4x 3.5-inch HDD extension box - Tower version

i The 4x 3.5-inch HDD extension box occupies accessible drive bays 1, 2 and 3. This box can also be equipped with a slimline ODD.

7.4.2 Installing an HDD extension box



Upgrade and Repair Unit (URU)



Hardware: 10 minutes

Tools: Slotted screw driver (for bending in or out accessible drive mounting brackets)

7.4.2.1 Preliminary steps

- ▶ ["Disabling BitLocker functionality" on page 79](#)
- ▶ ["Shutting down the server" on page 50](#)
- ▶ ["Disconnecting the server from the mains" on page 50](#)
- ▶ ["Getting access to the component" on page 51](#)



The front cover only needs to be removed in order to remove or install accessible drive dummy covers.

- ▶ ["Removing the system fan holder" on page 76](#)
- ▶ Installing a 2x 3.5-inch HDD extension box: ["Installing the slimline ODD or LSD" on page 300](#) (if applicable)
- ▶ Installing a 4x 3.5-inch HDD extension box: ["Installing the slimline ODD" on page 314](#) (if applicable)

7.4.2.2 Removing accessible drive dummy covers

Removing accessible drive filler covers



Figure 103: Removing an accessible drive filler cover

- ▶ Hold the accessible drive filler cover by its two handle recesses and pull it out of the desired installation bays.



CAUTION!

Always replace filler covers into unused drive bays to comply with applicable EMC regulations and satisfy cooling requirements.

Removing accessible drive covers

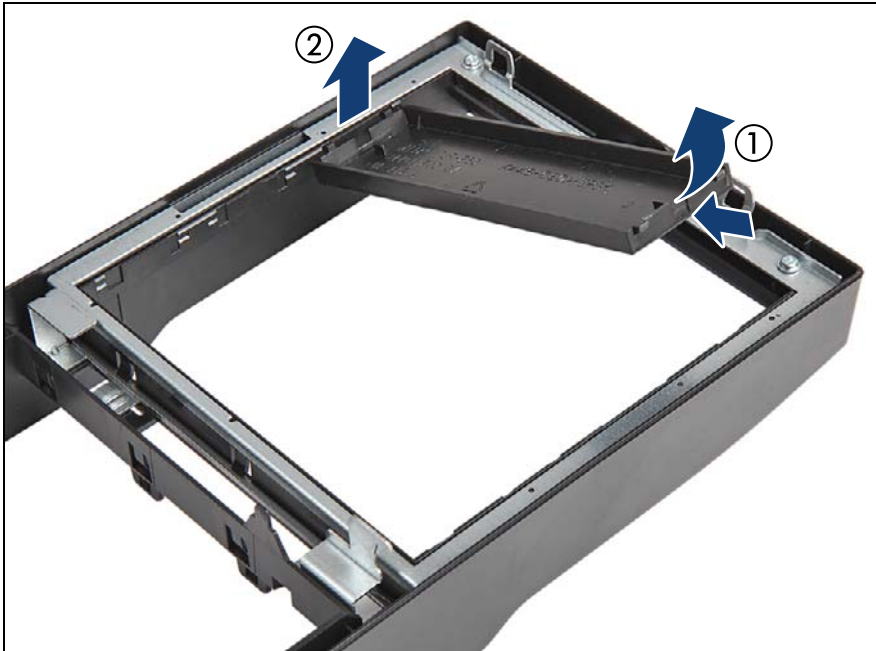

Figure 104: Removing an accessible drive covers

i Removing accessible drive covers is illustrated by the example of the tower server. In case of the rack front cover, the procedure is identical.

- ▶ Turn the front cover face down.
- ▶ Press in on the lugs on either side of the drive cover.
- ▶ Fold up (1) and remove the desired accessible drive covers (2).

7.4.2.3 Installing the HDD extension box

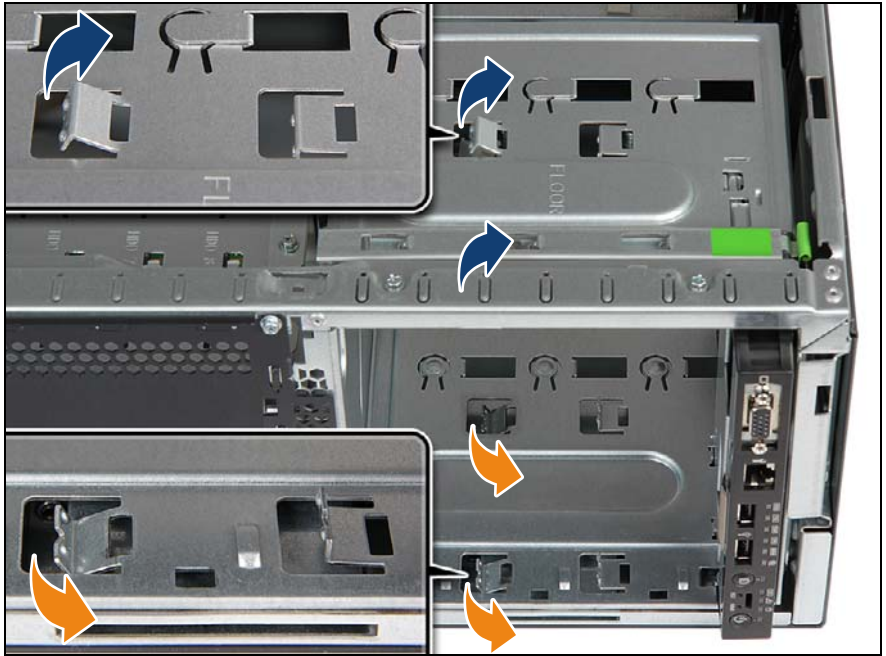

Figure 105: Checking mounting bracket positions

i Installing a 4x 3.5-inch HDD extension box: bend all mounting brackets outward.

- ▶ Using a screw driver, bend the mounting brackets of the middle installation bay outwards (see close-up):
 - ▶ Bend up the upper two mounting brackets (see blue arrows).
 - ▶ Bend down the lower two mounting brackets (see orange arrows).

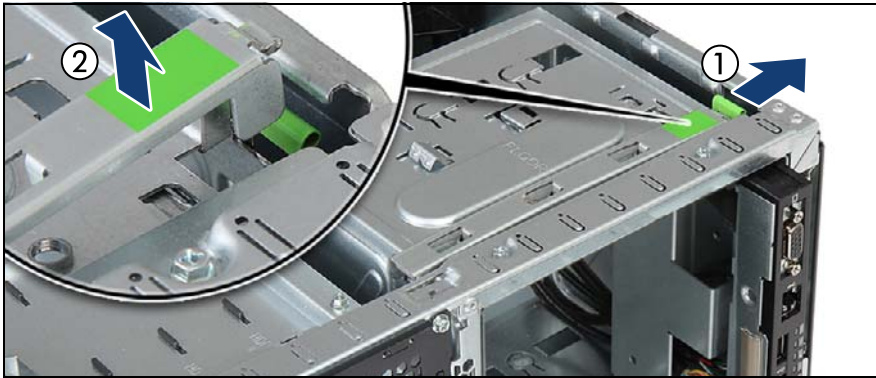

Figure 106: Opening the accessible drive locking bar

- ▶ Press out on the locking latch to disengage the accessible drive locking bar (1).
- ▶ Fold up the accessible drive locking bar (2).

i Unlocking and securing the front panel and accessible drives is illustrated by the example of tower servers. In case of rack servers, the accessible drive locking bar is located on the side of the drive bay. In this case, proceed as follows:

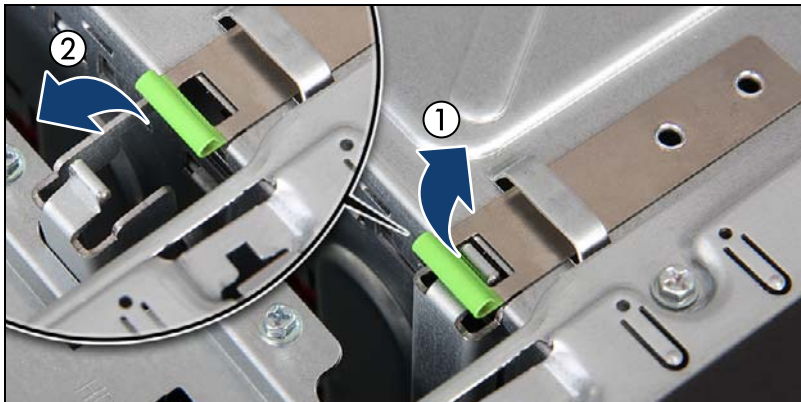

Figure 107: Opening the accessible drive locking bar (rack systems)

- ▶ Pull up on the locking latch to disengage the accessible drive locking bar (1).
- ▶ Fold out the accessible drive locking bar (2).

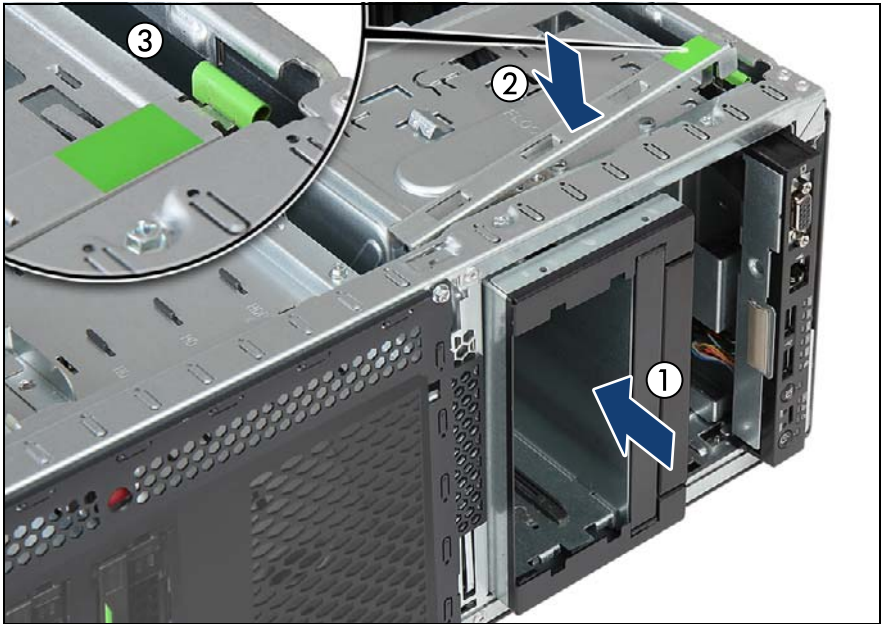

Figure 108: Inserting the HDD extension box (example 2x 3.5-inch HDD extension box)

- ▶ Insert the HDD extension box into installation bays (1) and carefully push in until the front screw hole on the front panel frame lines up with the centering pin on the locking bar.
- ▶ Close the locking bar (2) until it locks in place (3).

i When working on a rack-mounted server, proceed as follows:

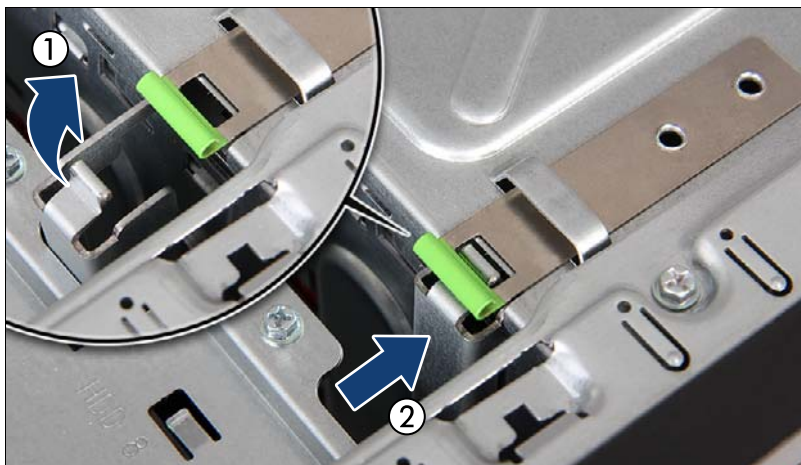

Figure 109: Closing the accessible drive locking bar (rack systems)

- ▶ Fold in the locking bar (1) until it locks in place (2, see close-up).
- ▶ Connect SAS and power cables to the HDD extension box see section ["Cabling plans" on page 403](#).
- ▶ If applicable, connect slimline ODD and LSD module cables see section ["Cabling plans" on page 403](#).
- ▶ Install HDD modules or HDD dummy modules into the additional HDD slots as described in sections ["2.5-inch HDD / SSD configurations" on page 136](#) or ["3.5-inch HDD configurations" on page 150](#).

7.4.2.4 Concluding steps

- ▶ ["Installing the system fan holder" on page 77](#)
- ▶ ["Reassembling" on page 64](#)
- ▶ ["Connecting the server to the mains" on page 74](#)
- ▶ ["Switching on the server" on page 75](#)
- ▶ ["Enabling BitLocker functionality" on page 100](#)

7.4.3 Removing an HDD extension box



**Upgrade and Repair Unit
(URU)**



Hardware: 10 minutes

Tools: tool-less

7.4.3.1 Preliminary steps

- ▶ ["Disabling BitLocker functionality" on page 79](#)
- ▶ ["Shutting down the server" on page 50](#)
- ▶ ["Disconnecting the server from the mains" on page 50](#)
- ▶ ["Getting access to the component" on page 51](#)



The front cover only needs to be removed in order to remove or install accessible drive dummy covers.

- ▶ ["Removing the system fan holder" on page 76](#)

7.4.3.2 Removing the HDD extension box

- ▶ Remove the HDD modules or HDD dummy modules.
- ▶ Remove all cables from the HDD extension box see section ["Cabling plans" on page 403](#).

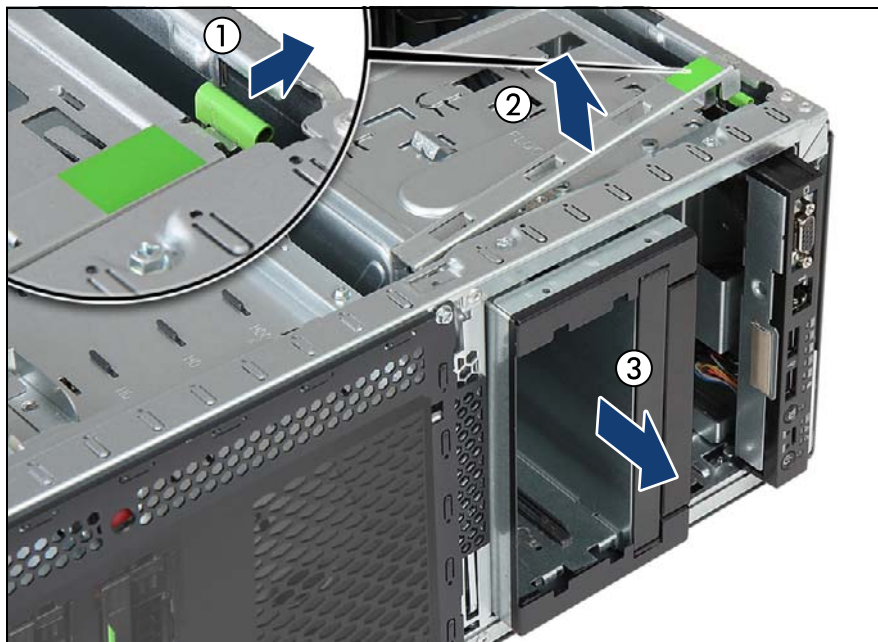

Figure 110: Removing the HDD extension box

- ▶ Press out on the locking latch to disengage the accessible drive locking bar (1).
- ▶ Fold up the accessible drive locking bar (2).
- ▶ Carefully pull the HDD extension box out of its installation bays (3).
- ▶ Close the accessible drive locking bar until it locks in place.

7.4.3.3 Installing accessible drive dummy covers

Installing accessible drive filler covers

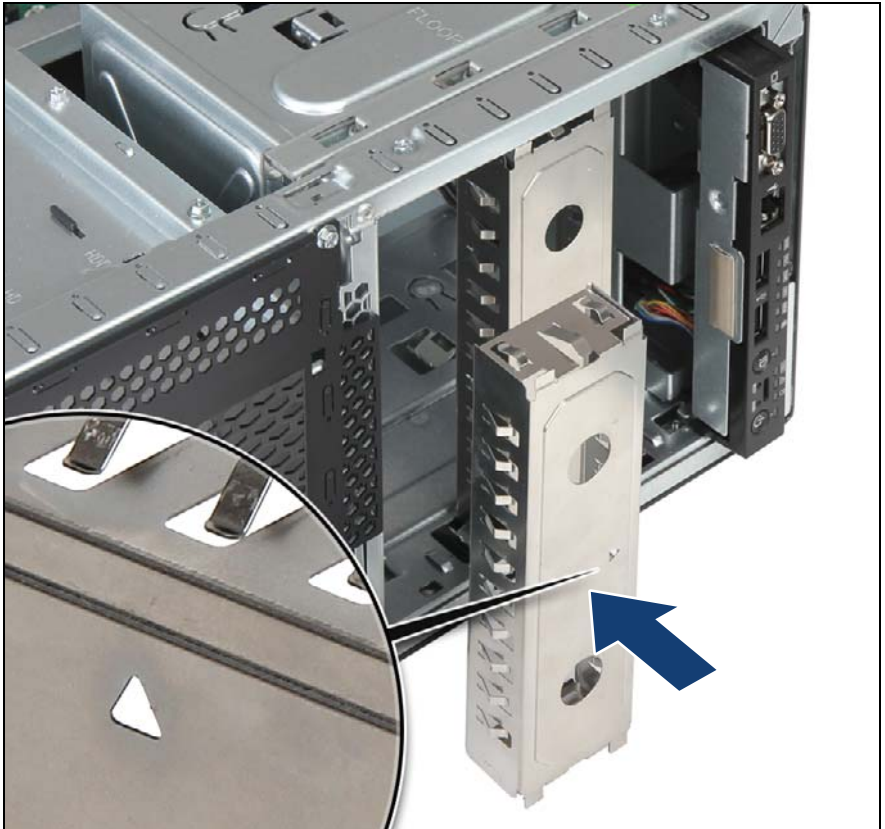

Figure 111: Installing an accessible drive filler cover

- ▶ Hold the accessible drive filler cover by its two handle recesses and insert it into the empty installation bays with the punched-out arrow symbol facing up (see close-up).



CAUTION!

Always replace filler covers into unused drive bays to comply with applicable EMC regulations and satisfy cooling requirements.

Installing accessible drive covers

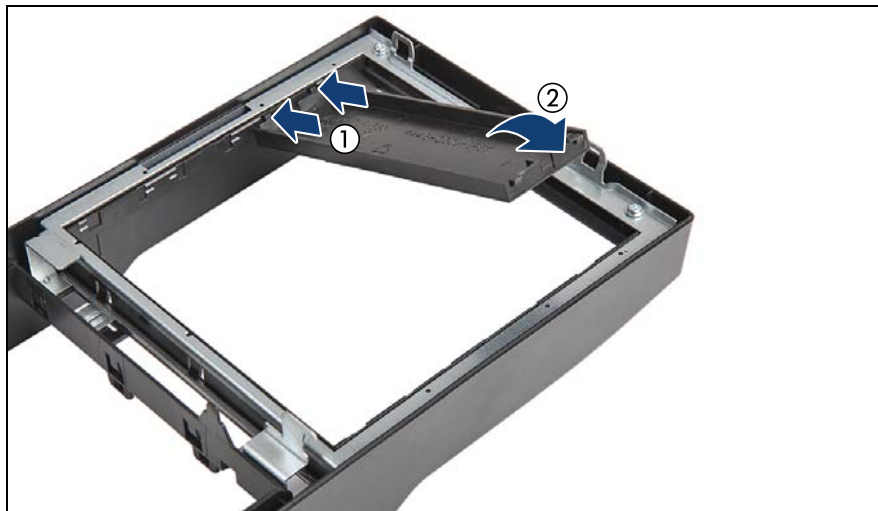

Figure 112: Installing accessible drive covers



Installing accessible drive covers is illustrated by the example of the tower server. In case of the rack front cover, the procedure is identical.

- ▶ Ensure that an accessible drive filler cover has been installed in every empty drive bay.
- ▶ Turn the front cover face down.
- ▶ Join the two lugs on one edge of the accessible drive cover with the right inner edge of the front cover (1).
- ▶ Fold down the accessible drive cover until it snaps in place (2).

7.4.3.4 Concluding steps

- ▶ Removing a 2x 3.5-inch HDD extension box: ["Removing the slimline ODD or LSD" on page 307](#) (if applicable)
- ▶ Removing a 4x 3.5-inch HDD extension box: ["Removing the slimline ODD" on page 320](#) (if applicable)
- ▶ ["Installing the system fan holder" on page 77](#)
- ▶ ["Reassembling" on page 64](#)

- ▶ ["Connecting the server to the mains" on page 74](#)
- ▶ ["Switching on the server" on page 75](#)
- ▶ ["Enabling BitLocker functionality" on page 100](#)

7.4.4 Replacing an HDD extension box



Upgrade and Repair Unit (URU)



Hardware: 10 minutes

Tools: tool-less

7.4.4.1 Preliminary steps

- ▶ ["Shutting down the server" on page 50](#)
- ▶ ["Disconnecting the server from the mains" on page 50](#)
- ▶ ["Getting access to the component" on page 51](#)
- ▶ ["Removing the system fan holder" on page 76](#)

7.4.4.2 Removing the defective HDD extension box

- ▶ Remove the HDD extension box as described in section ["Removing an HDD extension box" on page 177](#).

7.4.4.3 Installing the new HDD extension box

- ▶ Install the HDD extension box as described in section ["Installing an HDD extension box" on page 170](#).

7.4.4.4 Concluding steps

- ▶ ["Installing the system fan holder" on page 77](#)
- ▶ ["Reassembling" on page 64](#)
- ▶ ["Connecting the server to the mains" on page 74](#)
- ▶ ["Switching on the server" on page 75](#)

8 Fans

Safety notes



CAUTION!

- Do not damage or modify internal cables or devices. Doing so may cause a device failure, fire, or electric shock.
- Devices and components inside the server remain hot after shutdown. After shutting down the server, wait for hot components to cool down before installing or removing internal options.
- Circuit boards and soldered parts of internal options are exposed and can be damaged by static electricity. Always discharge static build-up (e.g. by touching a grounded object) before handling electrostatic-sensitive devices (ESDs).
- Do not touch the circuitry on boards or soldered parts. Hold circuit boards by their metallic areas or edges.
- If devices are installed or disassembled using methods other than those outlined in this chapter, the warranty will be invalidated.
- For further information, please refer to chapter "[Important information](#)" on page 35.

8.1 Basic information

The following fans are available:

- three system fans included in a system fan holder
- one rear fan (only available in a redundant power supply configuration)



Additional fans in power supply units are integral parts of the power supply units and cannot be replaced separately.

Fans



Figure 113: System fan holder with three system fans (fan 1-3)



Figure 114: Rear fan (fan 4)

Fan numbering

Refer to the below figure for the fan numbering scheme in ServerView Operations Manager:

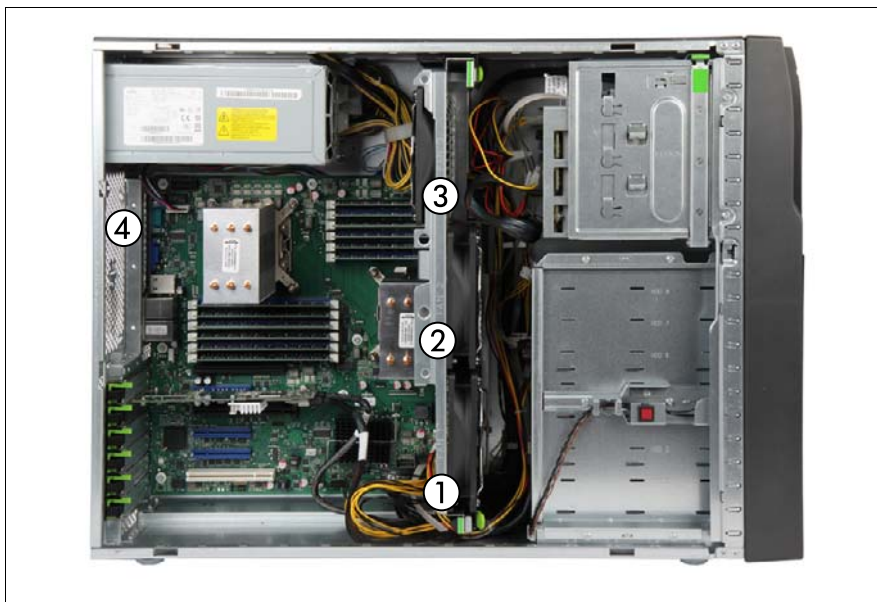

Figure 115: Fan numbering

1	System fans 1 -3 in the system fan holder
2	
3	
4	Rear fan

8.2 System fans

8.2.1 Replacing the system fans



Field Replaceable Unit (FRU)



Hardware: 5 minutes

Tools: tool-less



The system fans are installed in the system fan holder. Only the complete system fan holder can be replaced as spare part.

8.2.1.1 Preliminary steps

- ▶ ["Shutting down the server" on page 50](#)
- ▶ ["Disconnecting the server from the mains" on page 50](#)
- ▶ ["Getting access to the component" on page 51](#)
- ▶ ["Removing the system air duct" on page 63](#)

8.2.1.2 Removing the defectice system fans

- ▶ Remove the system fan holder as described in section ["Removing the system fan holder" on page 76](#).

8.2.1.3 Installing the new system fans

- ▶ Install the system fan holder as described in section ["Installing the system fan holder" on page 77](#).

8.2.1.4 Concluding steps

- ▶ ["Installing the system air duct" on page 64](#)
- ▶ ["Reassembling" on page 64](#)
- ▶ ["Connecting the server to the mains" on page 74](#)
- ▶ ["Switching on the server" on page 75](#)

- ▶ For the Japanese market: after replacing the system fans, it is necessary to execute a fan test. Follow the instructions provided separately.

8.3 Rear fan

8.3.1 Installing the rear fan



Upgrade and Repair Unit (URU)



Hardware: 5 minutes

Tools: tool-less

8.3.1.1 Preliminary steps

- ▶ ["Shutting down the server" on page 50](#)
- ▶ ["Disconnecting the server from the mains" on page 50](#)
- ▶ ["Getting access to the component" on page 51](#)

8.3.1.2 Installing the rear fan

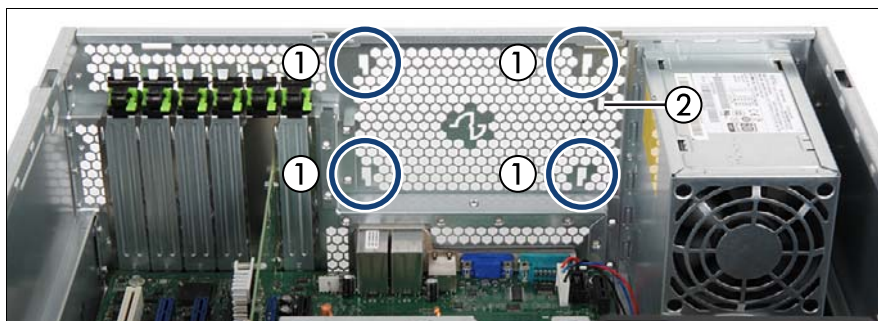

Figure 116: Rear fan - slots in the chassis

- ▶ Note the four slots in the chassis for installing the rear fan (1) and the slot for the latch on the locking lever (2).



Figure 117: Rear fan - hooks

- Note the four hooks on the rear fan (1) and the slot for the latch on the locking lever (2).

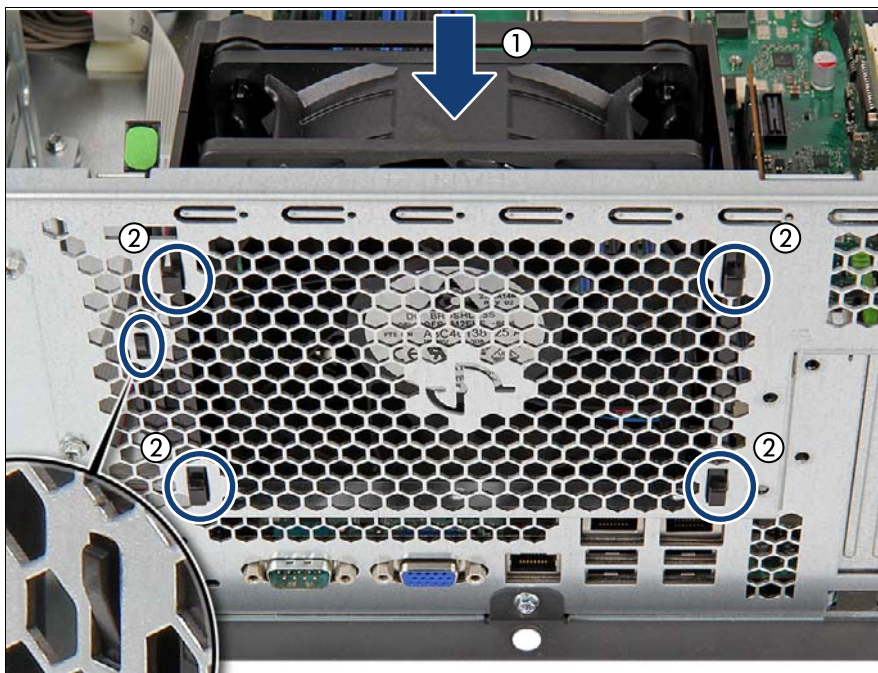

Figure 118: Installing the rear fan

- ▶ Insert the rear fan (1) and fit the four hooks on the fan into the slots (2).
- ▶ Press down the rear fan until the latch on the locking lever properly engages in the slot on the server rear (see close-up).
- ▶ Ensure that the rear fan is properly seated in the chassis.

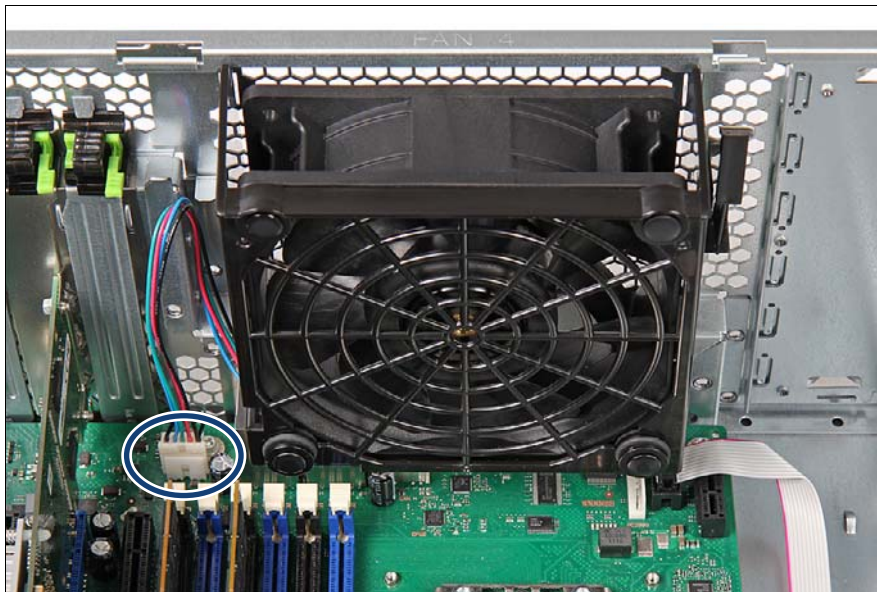

Figure 119: Connecting the rear fan cable

- ▶ Connect the rear fan cable to the connector "FAN 4" on the system board.

8.3.1.3 Concluding steps

- ▶ ["Reassembling" on page 64](#)
- ▶ ["Connecting the server to the mains" on page 74](#)
- ▶ ["Switching on the server" on page 75](#)

8.3.2 Removing the rear fan



Field Replaceable Unit
(FRU)



Hardware: 5 minutes

Tools: tool-less

8.3.2.1 Preliminary steps

- ▶ ["Shutting down the server" on page 50](#)
- ▶ ["Disconnecting the server from the mains" on page 50](#)
- ▶ ["Getting access to the component" on page 51](#)

8.3.2.2 Removing the rear fan

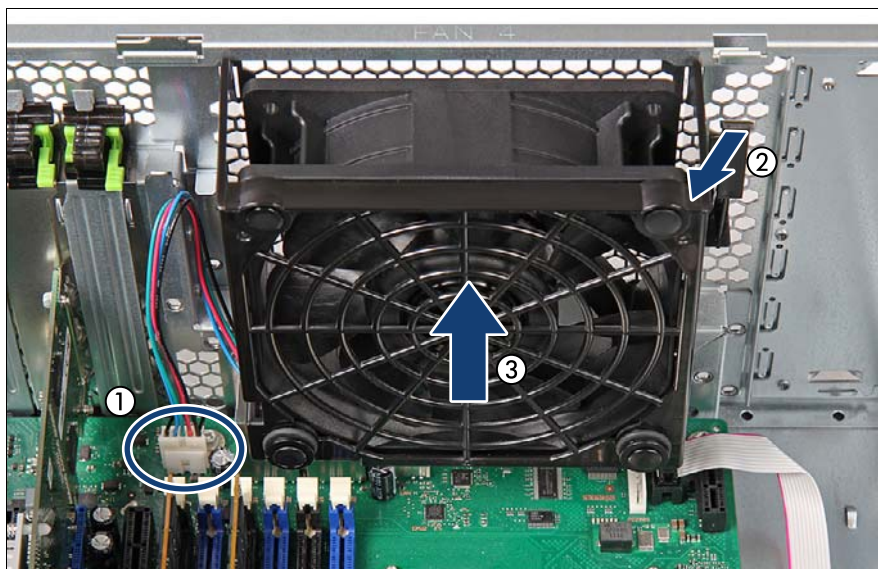

Figure 120: Removing the rear fan (A)

- ▶ Disconnect the fan cable from the connector "FAN 4" on the system board (1).
- ▶ Pull the locking lever (2) while lifting up the rear fan (3).

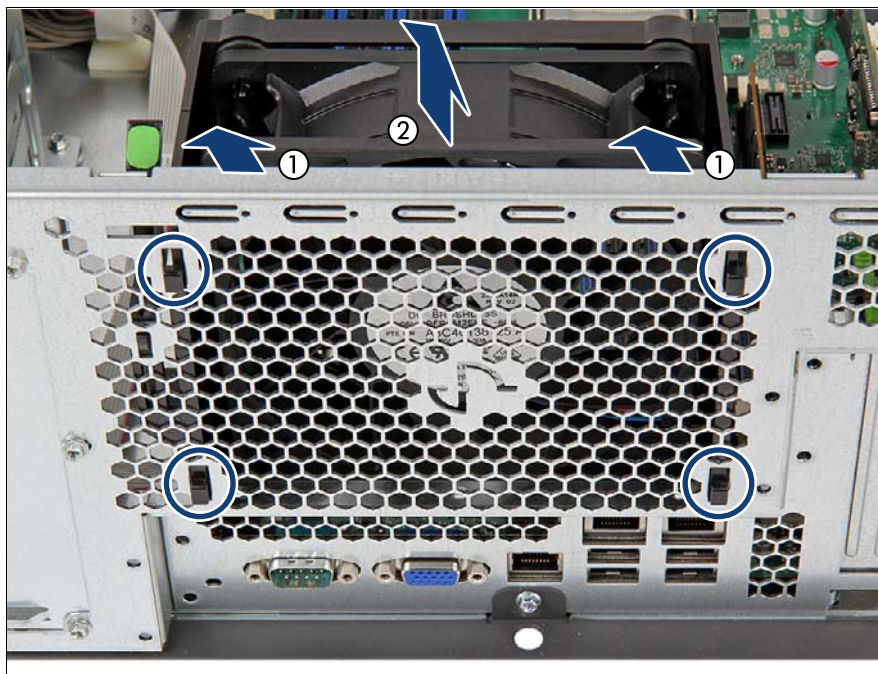

Figure 121: Removing the rear fan (B)

- ▶ Disengage the four hooks (see circles) from the slots on the rear (1).
- ▶ Remove the rear fan (2).

8.3.2.3 Concluding steps

- ▶ ["Reassembling" on page 64](#)
- ▶ ["Connecting the server to the mains" on page 74](#)
- ▶ ["Switching on the server" on page 75](#)

8.3.3 Replacing the rear fan



Field Replaceable Unit (FRU)



Hardware: 5 minutes

Tools: tool-less

8.3.3.1 Preliminary steps

- ▶ ["Shutting down the server" on page 50](#)
- ▶ ["Disconnecting the server from the mains" on page 50](#)
- ▶ ["Getting access to the component" on page 51](#)
- ▶ ["Removing the system air duct" on page 63](#)

8.3.3.2 Removing the defectice rear fan

- ▶ Remove the rear fan as described in section ["Removing the rear fan" on page 191](#).

8.3.3.3 Installing the new rear fan

- ▶ Install the rear fan as described in section ["Installing the rear fan" on page 187](#).

8.3.3.4 Concluding steps

- ▶ ["Installing the system air duct" on page 64](#)
- ▶ ["Reassembling" on page 64](#)
- ▶ ["Connecting the server to the mains" on page 74](#)
- ▶ ["Switching on the server" on page 75](#)
- ▶ For the Japanese market: after replacing the rear fan, it is necessary to execute a fan test. Follow the instructions provided separately.

9 Expansion cards and backup units

Safety notes



CAUTION!

- Do not damage or modify internal cables or devices. Doing so may cause a device failure, fire, or electric shock.
- Devices and components inside the server remain hot after shutdown. After shutting down the server, wait for hot components to cool down before installing or removing internal options.
- Circuit boards and soldered parts of internal options are exposed and can be damaged by static electricity. Always discharge static build-up (e.g. by touching a grounded object) before handling electrostatic-sensitive devices (ESDs).
- Do not touch the circuitry on boards or soldered parts. Hold circuit boards by their metallic areas or edges.
- If devices are installed or disassembled using methods other than those outlined in this chapter, the warranty will be invalidated.
- For further information, please refer to chapter "[Important information](#)" on page 35.

9.1 Basic information

The system board is equipped with six expansion slots:

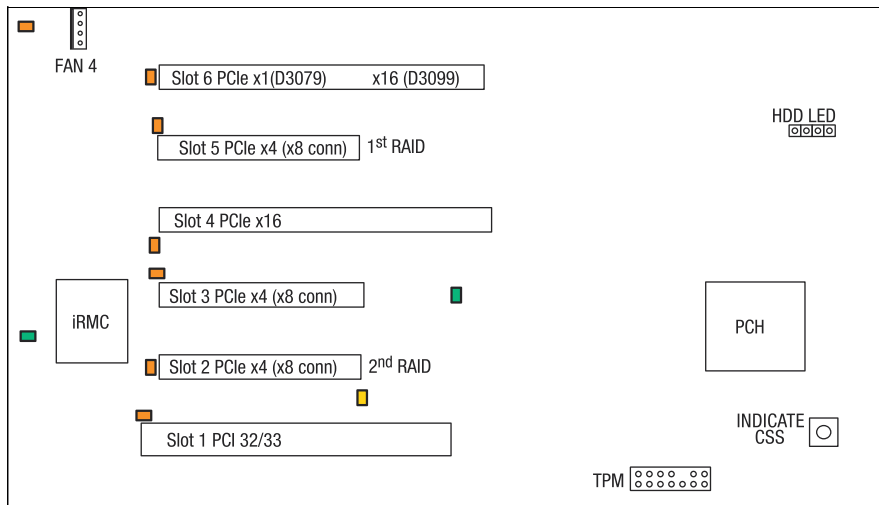

Figure 122: PCI slot overview

PCI slot	Type	Mechanical connector	Electrical interface	Function
1	PCI 32 / 33 MHz	x8	x4	preferred slot for first SAS RAID controller
2	PCIe Gen 3	x8	x4	
3	PCIe Gen 3	x8	x4	
4	PCIe Gen 3	x16	x16	
5	PCIe Gen 2	x8	x4	preferred slot for second SAS RAID controller
6	PCIe Gen 3	x16	x16 (D3099 / TX200 S7) x1 (D3079 / TX150 S8)	

Expansion card overview

Rule #	PCI Controller	max. #	TX200S7						TX150S8					
			PCI 32/33	PCIe x4	PCIe x4	PCIe x16	PCIe x4	PCIe x16	PCI 32/33	PCIe x4	PCIe x4	PCIe x16	PCIe x4	PCIe x1
			PCH	PCH	CPU1	CPU1	CPU1	CPU2	PCH	PCH	CPU1	CPU1	CPU1	PCH
Slot #	Slot #	Slot #	Slot #	Slot #	Slot #	Slot #	Slot #	Slot #	Slot #	Slot #	Slot #	Slot #		
1	SAS/Raid (D2607) Lynx2	2	-	2	-	-	1	-	-	2	-	-	1	-
2	SAS/Raid (D2616) Cougar2	2	-	2	-	-	1	-	-	2	-	-	1	-
3	SAS/Raid (D3116) Cougar3	2	-	-	-	-	1	-	-	-	-	-	1	-
4	LAN10Gbit (D2755) Niantic	1	-	-	-	1	3	2	-	-	3	1	2	-
5	LP12002/QLE 2562	2	-	5	4	1	3	2	-	-	-	-	-	-
6	LP1250 / QLE2560	2	-	3	2	4	1	5	-	-	-	-	-	-
7	NVS300 (PCIe x1)	1	-	1	3	-	2	-	-	3	-	2	1	-
8	LSI SAS RAID 9280-8e WASAT	2	-	1	-	3	2	4	-	1	-	3	2	-
9	LSI SAS RAID 9285CV-8e Procyon-U	1	-	-	-	2	1	3	-	-	-	-	-	-
10	SAS Tape Ctrl. (LSI 9200-8e)	2	-	3	2	4	1	5	-	3	2	4	1	-
11	1GbE CT Desktop	4	-	3	2	4	1	5	-	4	2	5	3	1
12	1GbE Quad D2745	2	-	3	2	4	1	5	-	3	2	4	1	5
13	1GbE Dual D2735	2	-	3	2	4	1	5	-	3	2	4	1	5
Order of Install Priority (1...n)							Order of Install Priority (1...n)							

Figure 123: Expansion card slot sequence



For the latest information on supported expansion cards, refer to your server's hardware configurator available online at the following address:

for the EMEA market:

http://ts.fujitsu.com/products/standard_servers/tower/primergy_tx200s7.html

http://ts.fujitsu.com/products/standard_servers/tower/primergy_tx150s8.html

for the Japanese market:

<http://jp.fujitsu.com/platform/server/primergy/system/>

9.2 Handling slot brackets

9.2.1 Installing a slot bracket



Upgrade and Repair Unit (URU)



Hardware: 5 minutes

Tools: Phillips PH2 / (+) No. 2 screw driver



Use the full height bracket perforated for the ModularRAID controllers based on LSI MegaRAID.

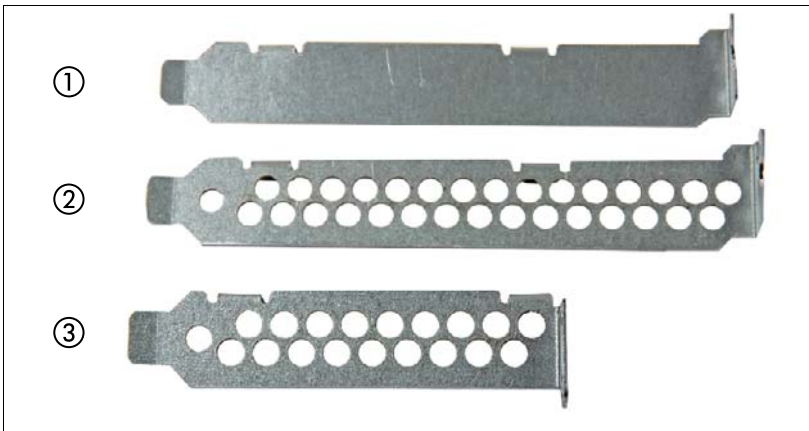

Figure 124: Perforated and non-perforated slot brackets

1	Full height bracket non-perforated
2	Full height bracket perforated
3	Low profile bracket perforated

Installing the slot bracket

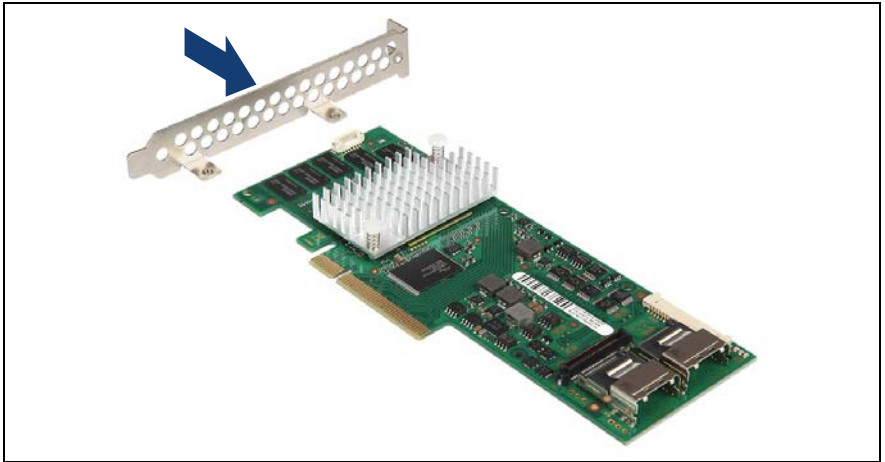

Figure 125: Installing the PCI slot bracket (A)

- ▶ Place the controller on the mounting tabs on the slot bracket.
- ▶ Carefully shift the slot bracket towards the controller until the plug shells engage with the cut-outs in the slot bracket connector panel.

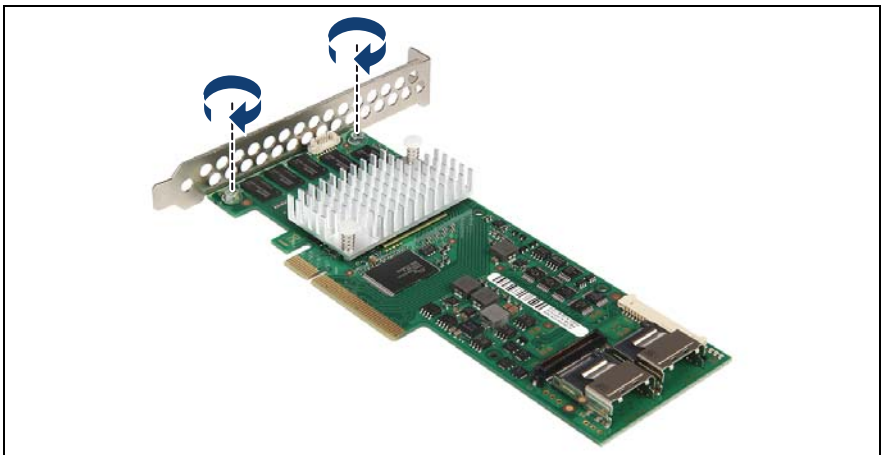

Figure 126: Installing the PCI slot bracket (B)

- ▶ Secure the slot bracket to the controller with two screws.

Example network adapter D2755

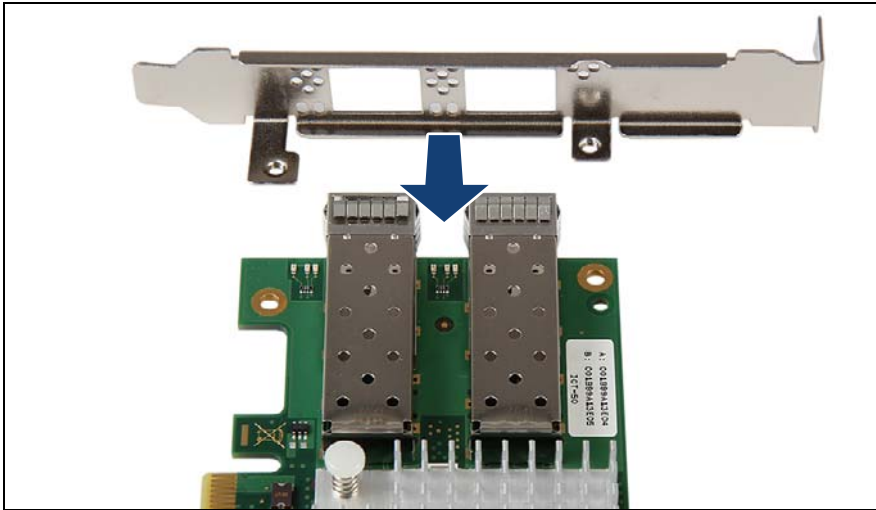

Figure 127: Installing the PCI slot bracket (A)

- ▶ Place the controller on the mounting tabs on the slot bracket.
- ▶ Carefully shift the slot bracket towards the controller until the plug shells engage with the cut-outs in the slot bracket connector panel.

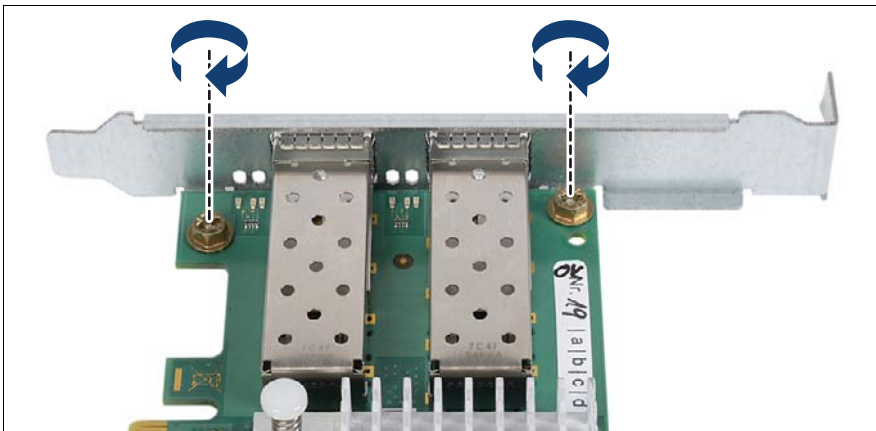

Figure 128: Installing the PCI slot bracket (B)

- ▶ Secure the slot bracket to the controller with two screws.

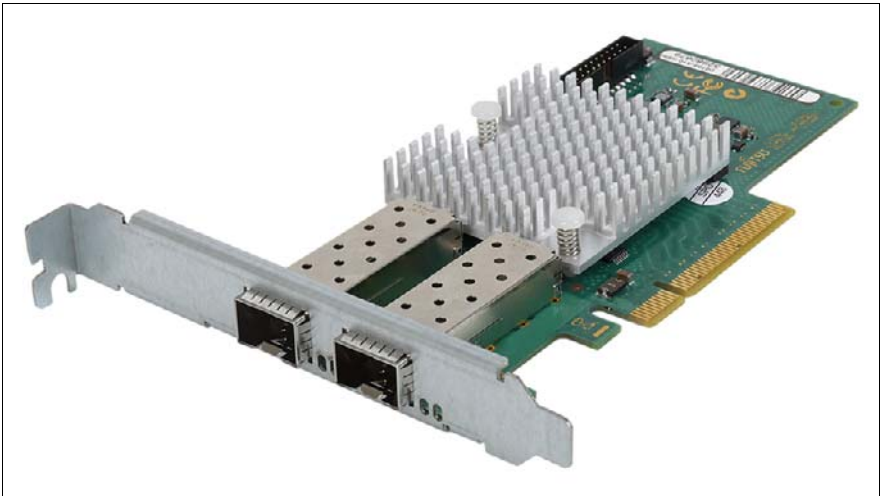

Figure 129: Assembled LAN controller D2755

9.2.2 Removing a slot bracket



**Upgrade and Repair Unit
(URU)**



Hardware: 5 minutes

Tools: Phillips PH2 / (+) No. 2 screw driver

Removing the slot bracket

- ▶ Remove the two screws.
- ▶ Remove the controller from the mounting tabs on the slot bracket.

9.3 Handling SFP+ transceiver modules

For Fiber Channel over Ethernet (FCoE) configurations, the Ethernet server adapter is equipped with one or two SFP+ (small form-factor pluggable) transceiver modules.

9.3.1 Installing SFP+ transceiver modules



Upgrade and Repair Unit (URU)



Hardware: 5 minutes

Tools: tool-less

Preparing the SFP+ transceiver module



Figure 130: Removing the protective optical port plug

- ▶ Remove the SFP+ transceiver module from its protective packaging.
- ▶ Remove the optical port plug from the new / additional SFP+ transceiver module.



CAUTION!

- Always keep the protective port plugs attached to the transceiver optical bores and fiber-optic cable connectors until you are ready to make a connection.
- Save the protective port plug for future use.



Figure 131: Unlatching the locking bail

- ▶ Carefully unlatch and fold down the locking bail on the SFP+ transceiver module.

Inserting the SFP+ transceiver module

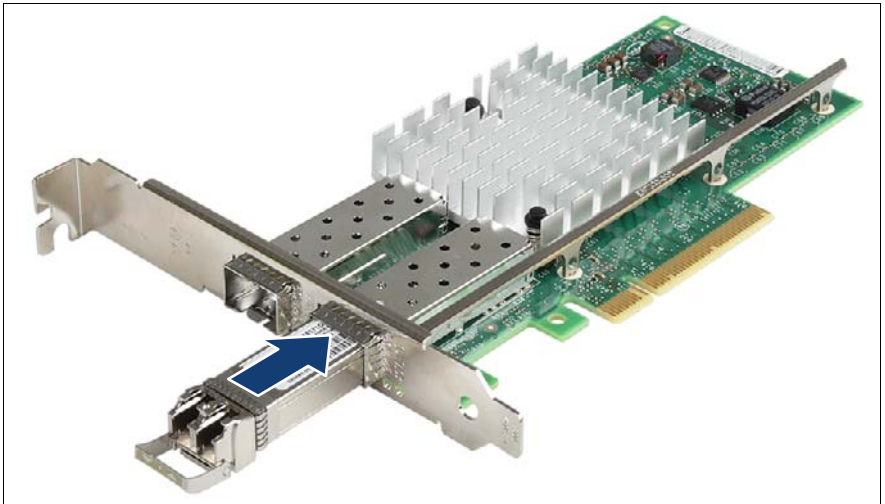

Figure 132: Inserting the SFP+ transceiver module

- ▶ Insert and slide the SFP+ transceiver module into the socket connector as far as it will go.



If only one slot is equipped with a SFP+ transceiver module, use the primary right connector.

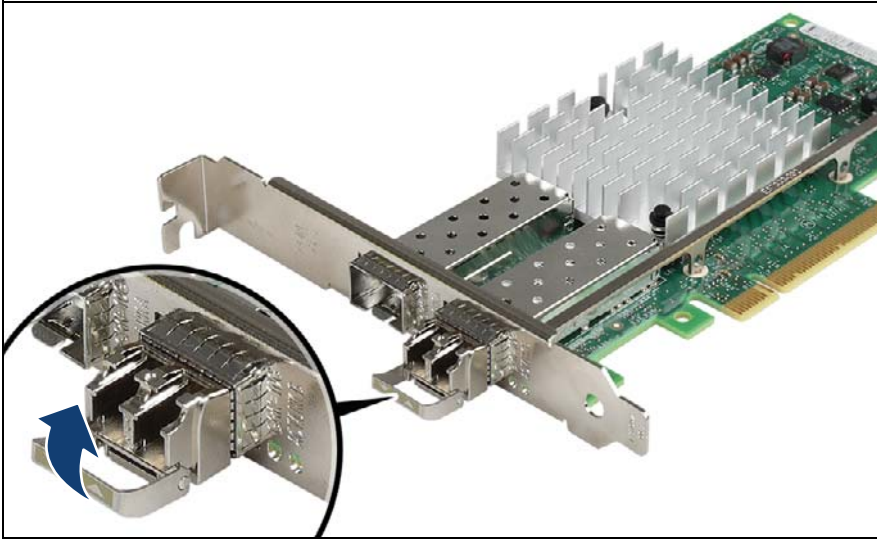

Figure 133: Latching the locking bail

- ▶ Carefully fold up and latch the locking bail.

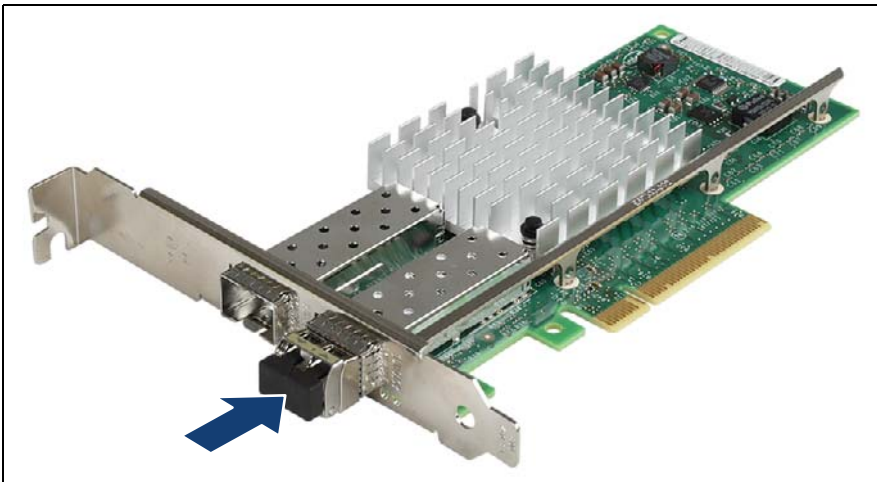

Figure 134: Attaching the protective optical port plug

- ▶ If the SFP+ transceiver module is not immediately connected to an LC connector, attach the protective optical port plug to the transceiver optical bores.

Installing the secondary SFP+ transceiver module



Figure 135: Installing the secondary SFP+ transceiver module

- ▶ If applicable, install the secondary SFP+ transceiver module accordingly.

9.3.2 Removing an SFP+ transceiver module



**Upgrade and Repair Unit
(URU)**



Hardware: 5 minutes

Tools: tool-less

For Fiber Channel over Ethernet (FCoE) configurations, the ethernet server adapter is equipped with one or two SFP+ (small form-factor pluggable) transceiver modules.

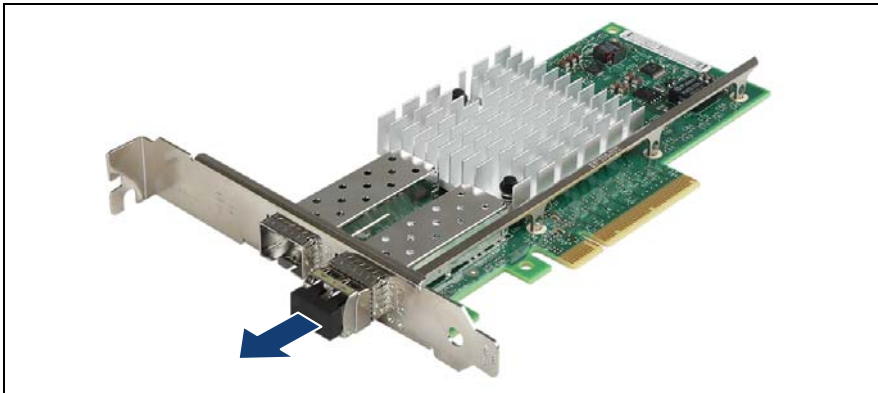

Figure 136: Removing the protective optical port plug

- ▶ If present, remove the protective optical port plug from the SFP+ transceiver module.



CAUTION!

Save the protective port plug for future use.

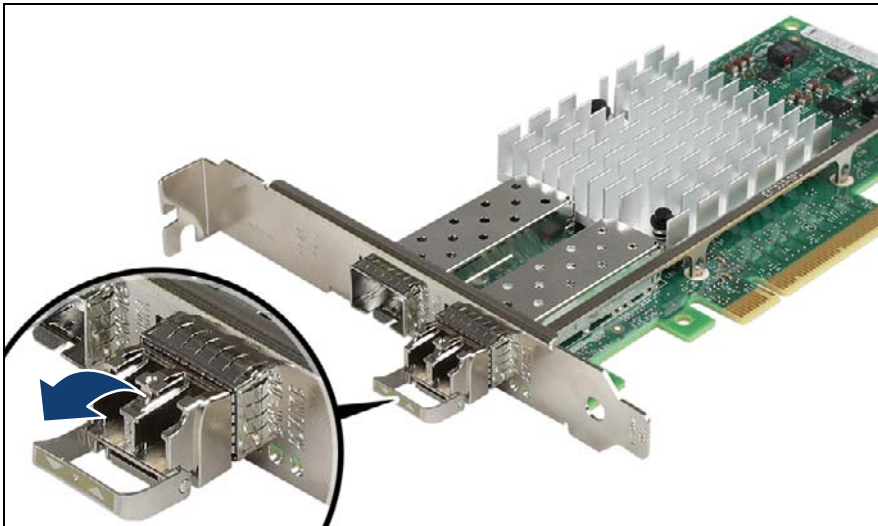

Figure 137: Unlatching the locking bail

- ▶ Carefully unlatch and fold down the locking bail on the SFP+ transceiver module to eject the transceiver from the socket connector.

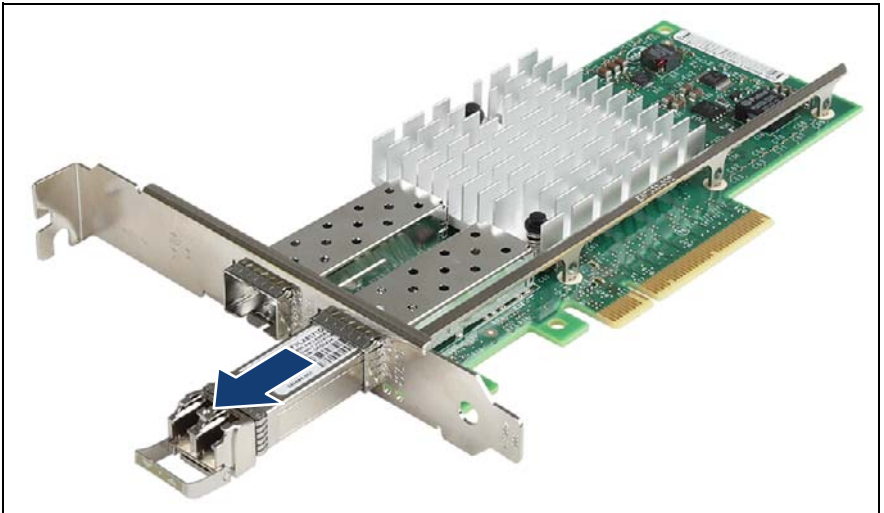

Figure 138: Removing the SFP+ transceiver

- ▶ Pull the SFP+ transceiver module out of its socket connector.
 - ▶ Reattach the protective optical port plug to the transceiver optical bores.
- i** Place the removed SFP+ transceiver module in an antistatic bag or other protective environment.

9.4 Expansion cards in PCI slots

9.4.1 Installing expansion cards



Upgrade and Repair Unit (URU)



Hardware: 5 minutes
Software: 5 minutes

Tools: Phillips PH2 / (+) No. 2 screw driver

9.4.1.1 Preliminary steps

- ▶ ["Disabling BitLocker functionality" on page 79](#)
- ▶ ["Disabling SVOM boot watchdog functionality" on page 80](#)
- ▶ ["Shutting down the server" on page 50](#)
- ▶ ["Disconnecting the server from the mains" on page 50](#)
- ▶ ["Getting access to the component" on page 51](#)

9.4.1.2 Removing the PCI slot bracket

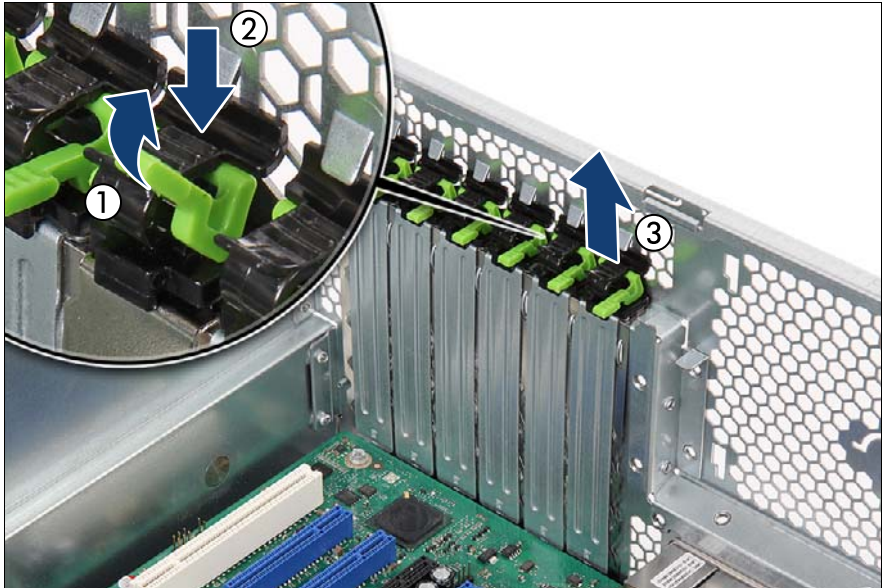

Figure 139: Removing the PCI slot bracket (A)

- ▶ Fold up the locking handle on the slot bracket clamp (1, see close-up).
- ▶ Press down on the slot bracket clamp to disengage it (2, see close-up).
- ▶ Remove the slot bracket clamp (3).
- ▶ If applicable, remove the slot bracket.



CAUTION!

Keep the slot bracket for further use.

Always replace slot brackets into unused PCI slot openings to comply with applicable EMC regulations and satisfy cooling requirements.

9.4.1.3 Installing an expansion card

- ▶ Remove the expansion card from its protective packaging.



For further instructions regarding controller settings, please refer to the accompanying documentation.

Expansion cards and backup units

- ▶ If applicable, attach the required slot bracket to the expansion card as described in section ["Installing a slot bracket"](#) on page 198.

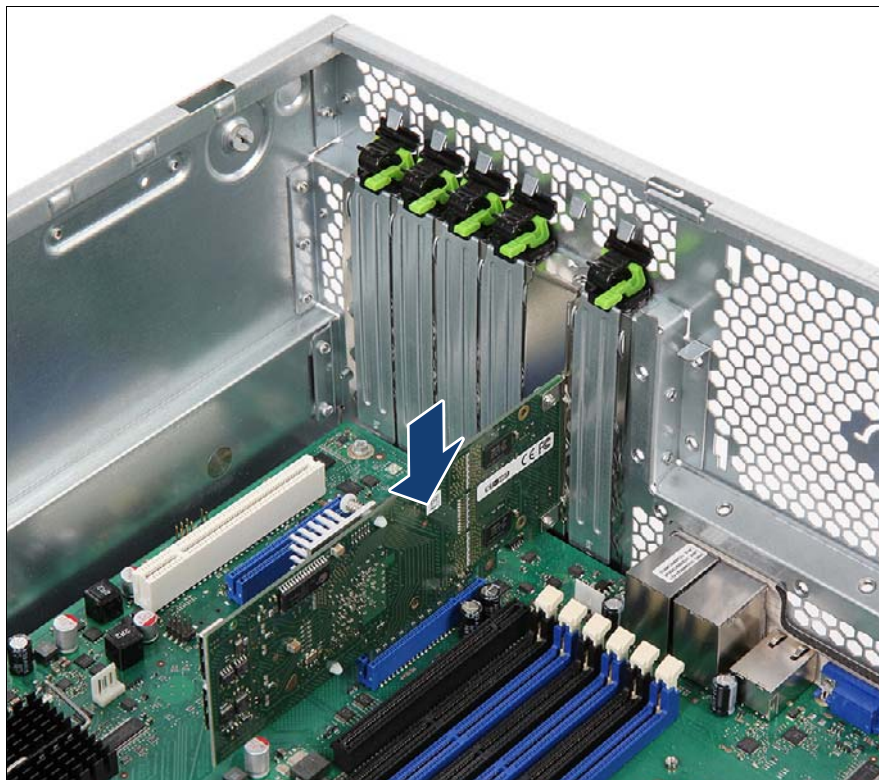

Figure 140: Installing the expansion card (A)

- ▶ Carefully insert the expansion card into the desired PCI slot and press down firmly until it is fully seated in the slot.



For slot preferences, please refer to section ["Basic information"](#) on page 196.

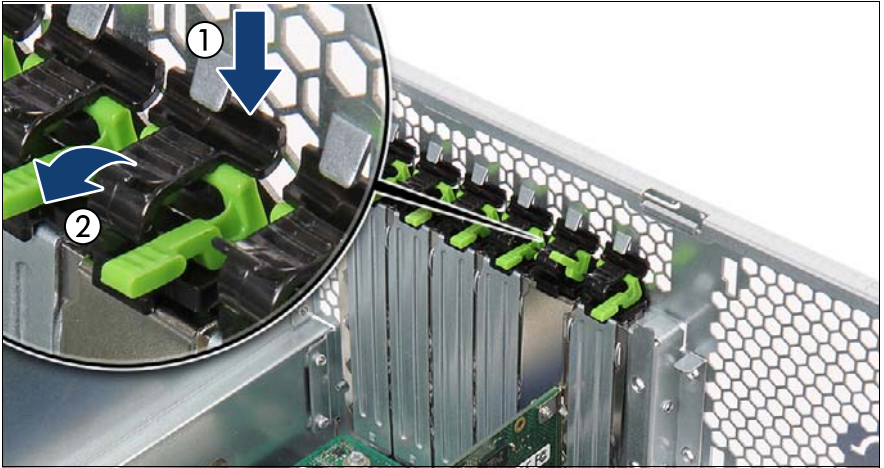

Figure 141: Installing the expansion card (B)

- ▶ Clip on the PCI slot bracket clamp (1).
- ▶ Fold down the locking handle on the PCI slot bracket clamp until it locks in place (2).

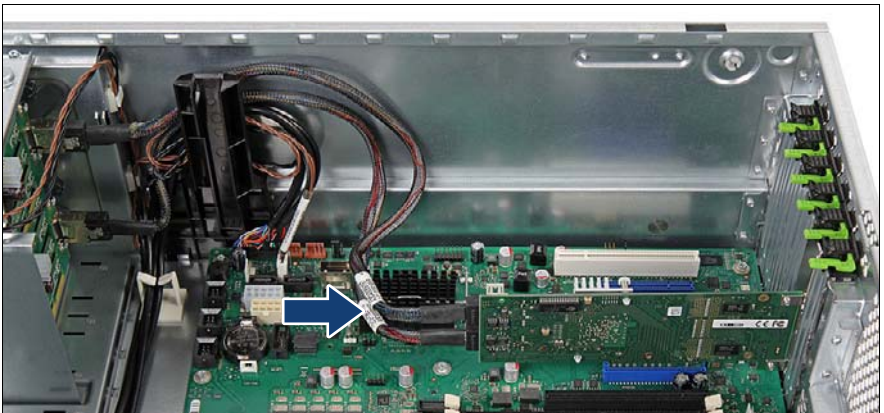

Figure 142: Connecting cables to the expansion card

- ▶ If applicable, connect internal cables to the expansion card (see section ["Cabling plans" on page 403](#)).



CAUTION!

Ensure that the RAID controller is not deformed.

Expansion cards and backup units

- ▶ If applicable, install SFP+ transceiver modules to the expansion card as described in sections ["Installing SFP+ transceiver modules" on page 202](#).
- ▶ If applicable, connect a BBU or FBU to the expansion card as described in sections ["Installing a BBU" on page 221](#) or ["Installing an FBU" on page 226](#).

9.4.1.4 Concluding steps

- ▶ ["Reassembling" on page 64](#)
- ▶ Reconnect all external cables to the replaced expansion card.
- ▶ ["Connecting the server to the mains" on page 74](#)
- ▶ ["Switching on the server" on page 75](#)
- ▶ ["Updating RAID controller firmware" on page 89](#)
- ▶ If applicable, ["Enabling Option ROM scan" on page 90](#) .
- ▶ ["Enabling SVOM boot watchdog functionality" on page 94](#)
- ▶ ["Enabling BitLocker functionality" on page 100](#)
- ▶ If applicable, ["After replacing / upgrading LAN controllers" on page 104](#)

9.4.2 Removing expansion cards



**Upgrade and Repair Unit
(URU)**



Hardware: 5 minutes

Tools: tool-less

9.4.2.1 Preliminary steps

- ▶ ["Disabling BitLocker functionality" on page 79](#)
- ▶ ["Shutting down the server" on page 50](#)
- ▶ Remove all external cables from the expansion card to be removed.
- ▶ ["Disconnecting the server from the mains" on page 50](#)
- ▶ ["Getting access to the component" on page 51](#)

9.4.2.2 Removing an expansion card

- ▶ If applicable, disconnect internal cables from the expansion card.

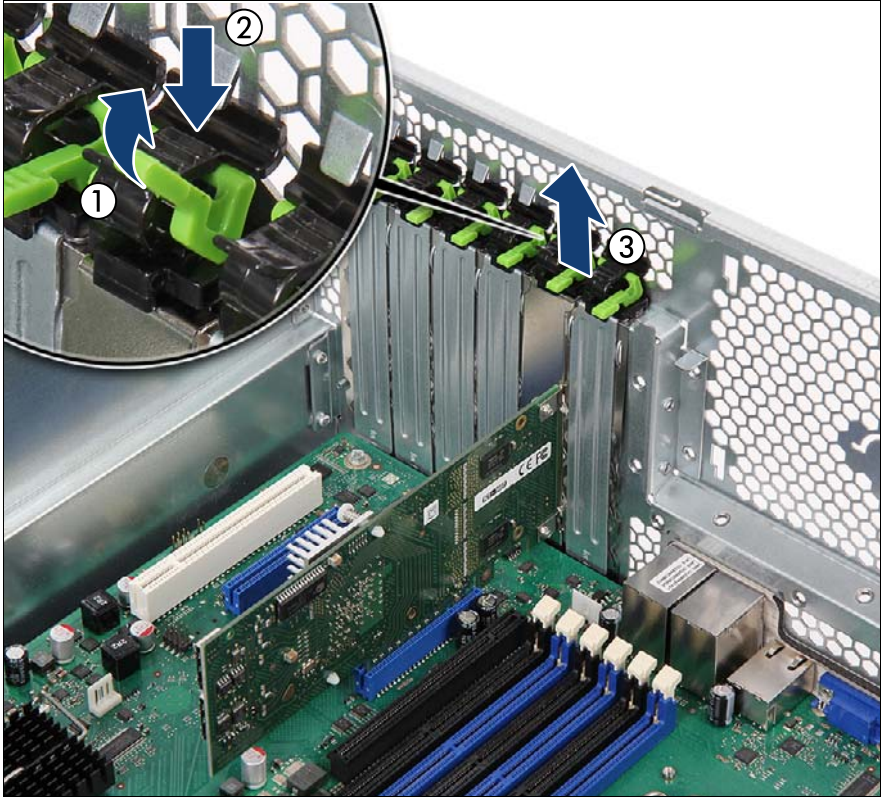

Figure 143: Removing the expansion card (A)

- ▶ If applicable, remove SFP+ transceiver modules ["Removing an SFP+ transceiver module"](#) on page 205.
- ▶ Fold up the locking handle on the slot bracket clamp (1, see close-up).
- ▶ Press down on the slot bracket clamp to disengage it (2, see close-up).
- ▶ Remove the slot bracket clamp (3).

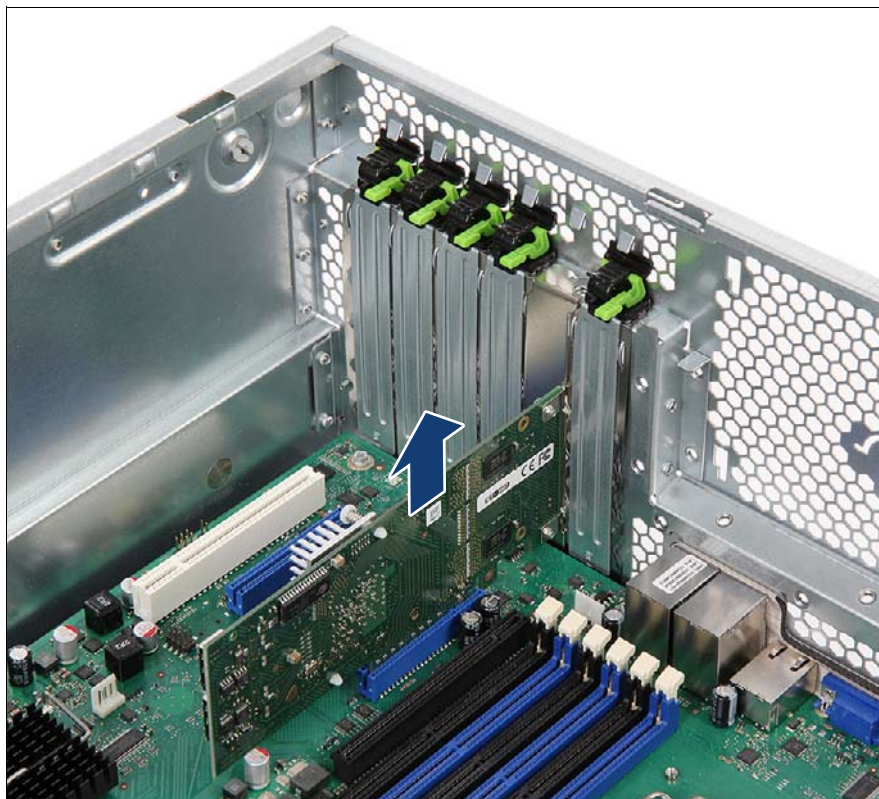

Figure 144: Removing the expansion card (B)

- ▶ Carefully pull up on the expansion card in a vertical motion and remove it from its slot.

9.4.2.3 Installing a PCI slot bracket



CAUTION!

Always replace slot brackets into unused PCI slot openings to comply with applicable EMC regulations and satisfy cooling requirements.

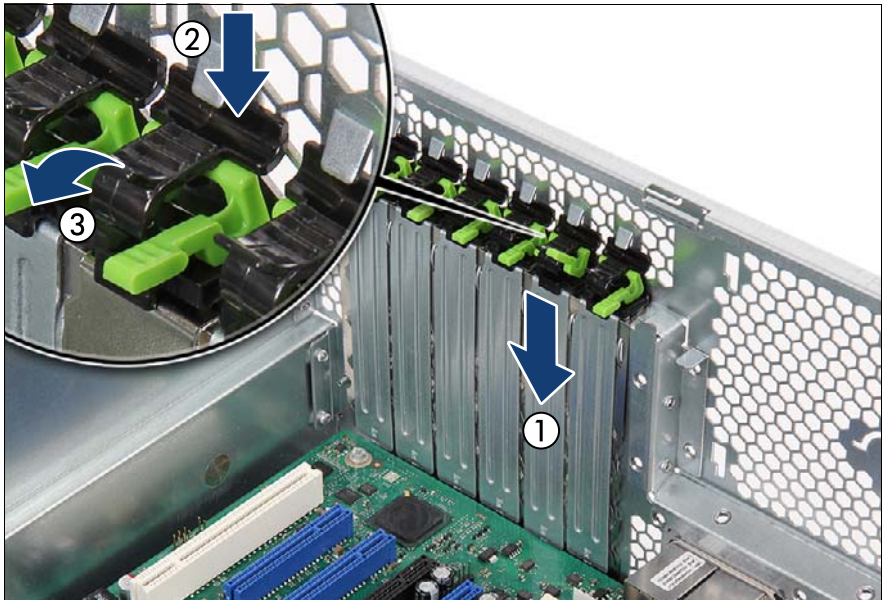

Figure 145: Installing a PCI slot bracket

- ▶ Insert a PCI slot bracket into the unused PCI slot opening (1).
- ▶ Clip on the PCI slot bracket clamp (2).
- ▶ Fold down the locking handle on the PCI slot bracket clamp until it locks in place (3).

9.4.2.4 Concluding steps

- ▶ ["Reassembling" on page 64](#)
- ▶ ["Connecting the server to the mains" on page 74](#)
- ▶ ["Switching on the server" on page 75](#)
- ▶ ["Enabling BitLocker functionality" on page 100](#)

9.4.3 Replacing expansion cards



Upgrade and Repair Unit (URU)



Hardware: 5 minutes
Software: 5 minutes

Tools: Phillips PH2 / (+) No. 2 screw driver (only for installing slot brackets)

Note on network settings recovery



When replacing network controllers or the system board, network configuration settings in the operating system will be lost and replaced by default values. This applies to all static IP address and LAN teaming configurations.

Ensure to note down your current network settings before replacing a controller or the system board.

9.4.3.1 Preliminary steps

- ▶ If applicable, ["Note on network settings recovery"](#) on page 216.
- ▶ ["Disabling BitLocker functionality"](#) on page 79
- ▶ ["Disabling SVOM boot watchdog functionality"](#) on page 80
- ▶ ["Locating the defective server"](#) on page 47
- ▶ ["Shutting down the server"](#) on page 50
- ▶ ["Disconnecting the server from the mains"](#) on page 50
- ▶ Remove all external cables from the expansion card to be replaced.
- ▶ ["Getting access to the component"](#) on page 51
- ▶ Locate the defective expansion card using the onboard Local Diagnostic LEDs as described in section ["Onboard indicators and controls"](#) on page 419.

9.4.3.2 Removing an expansion card

- ▶ If applicable, remove SFP+ transceiver modules from the expansion card to be removed, as described in section ["Removing an SFP+ transceiver module"](#) on page 205.

- ▶ Remove the defective expansion card as described in section "[Removing expansion cards](#)" on page 212.
- ▶ If the slot bracket on the defective expansion card is to be reused, remove it from the board as described in section "[Removing a slot bracket](#)" on page 201.

9.4.3.3 Installing an expansion card

- ▶ If applicable, install a slot bracket on the new expansion card as described in section "[Installing a slot bracket](#)" on page 198.
- ▶ Install the new expansion card as described in section "[Installing expansion cards](#)" on page 208.
- ▶ If applicable, reinstall SFP+ transceiver modules on the new expansion card, as described in section "[Installing SFP+ transceiver modules](#)" on page 202.

9.4.3.4 Connecting cables to the expansion card

- ▶ If applicable, connect internal cables to the expansion card.



For a complete cabling overview, please refer to section "[Cabling plans](#)" on page 403.

9.4.3.5 Connecting a backup unit to the expansion card

- ▶ If applicable, connect a BBU or FBU to the expansion card as described in sections "[Installing a BBU](#)" on page 221 or "[Installing an FBU](#)" on page 226.

9.4.3.6 Concluding steps

- ▶ "[Reassembling](#)" on page 64
- ▶ Reconnect all external cables to the replaced expansion card.
- ▶ "[Connecting the server to the mains](#)" on page 74
- ▶ "[Enabling replaced components in the system BIOS](#)" on page 95
- ▶ Inform the customer about changed WWN and MAC addresses. For further information, refer to section "[Looking up changed MAC / WWN addresses](#)" on page 101.
- ▶ "[Updating the NIC configuration file in a Linux environment](#)" on page 98

Expansion cards and backup units

- ▶ ["Updating RAID controller firmware" on page 89](#)
- ▶ ["Enabling SVOM boot watchdog functionality" on page 94](#)
- ▶ ["Switching on the server" on page 75](#)
- ▶ ["Enabling BitLocker functionality" on page 100](#)
- ▶ If applicable, reconfigure your network settings in the operation system according to the original configuration of the replaced controller (expansion card or onboard).



Configuration of network settings should be performed by the customer.

For further information, please refer to section ["Note on network settings recovery" on page 216](#).

- ▶ If applicable, ["After replacing / upgrading LAN controllers" on page 104](#).

9.4.4 Replacing TFM



Upgrade and Repair Unit (URU)



Hardware: 5 minutes

Tools: Phillips PH1 / (+) No. 1 screw driver

9.4.4.1 Preliminary steps

- ▶ ["Locating the defective server" on page 47](#)
- ▶ ["Shutting down the server" on page 50](#)
- ▶ ["Disconnecting the server from the mains" on page 50](#)
- ▶ Remove all external cables from the expansion card to be replaced.
- ▶ ["Getting access to the component" on page 51](#)
- ▶ Locate the defective expansion card using the onboard Local Diagnostic LEDs as described in section ["Onboard indicators and controls" on page 419](#).

9.4.4.2 Removing the defective TFM

- ▶ Remove the depending expansion card as described in section ["Removing an expansion card" on page 213](#).
- ▶ Disconnect the FBU cable from the TFM.

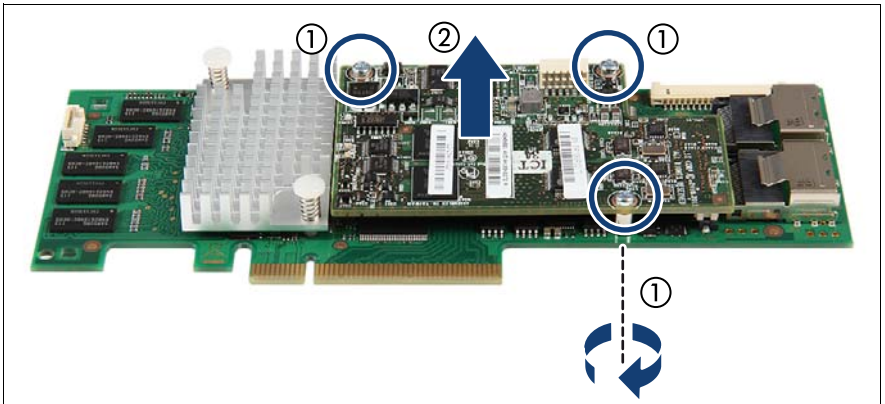

Figure 146: Removing the TFM

- ▶ Remove the three screws (1).
- ▶ Remove the TFM (2).

9.4.4.3 Installing the new TFM

- ▶ Install the new TFM as described in section ["Installing TFM to the RAID controller \(if applicable\)" on page 226](#).
- ▶ Connect the FBU cable to the TFM.
- ▶ Install the expansion card as described in section ["Installing an expansion card" on page 209](#).

9.4.4.4 Concluding steps

- ▶ ["Reassembling" on page 64](#)
- ▶ Reconnect all external cables to the replaced expansion card.
- ▶ ["Connecting the server to the mains" on page 74](#)
- ▶ ["Switching on the server" on page 75](#)

9.5 Backup Units

9.5.1 Basic information

The Battery Backup Unit (BBU) or Flash Backup Unit (FBU) backs up the memory contents of the connected SAS RAID controller in the event of a power failure. The PRIMERGY TX150 S8 / TX200 S7 server can accommodate up to two backup units.

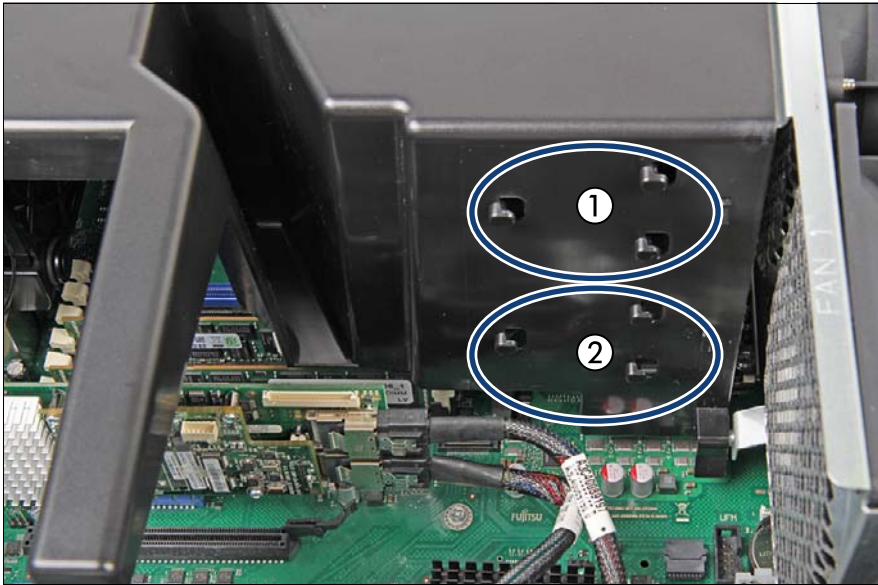

Figure 147: BBU / FBU mounting positions

1	Mounting position for first BBU / FBU
2	Mounting position for second BBU / FBU

9.5.2 Installing a BBU



Upgrade and Repair Unit
(URU)



Hardware: 5 minutes

Tools: tool-less



CAUTION!

For further safety information, please refer to chapter "[Important information](#)" on page 35.

9.5.2.1 Preliminary steps

- ▶ "[Disabling SVOM boot watchdog functionality](#)" on page 80
- ▶ "[Shutting down the server](#)" on page 50
- ▶ "[Disconnecting the server from the mains](#)" on page 50
- ▶ "[Getting access to the component](#)" on page 51

9.5.2.2 Connecting the BBU cable to the BBU

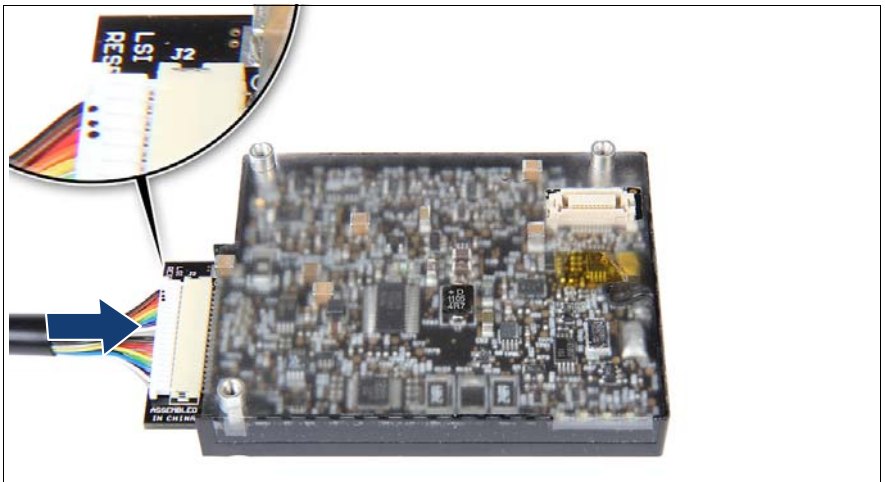

Figure 148: Connecting the BBU cable

Expansion cards and backup units

- ▶ Connect the BBU cable to the BBU board.



CAUTION!

Make sure that the connector side with the three dots points towards you (see close-up). Otherwise, short-circuits may result!

9.5.2.3 Installing the BBU in the holder

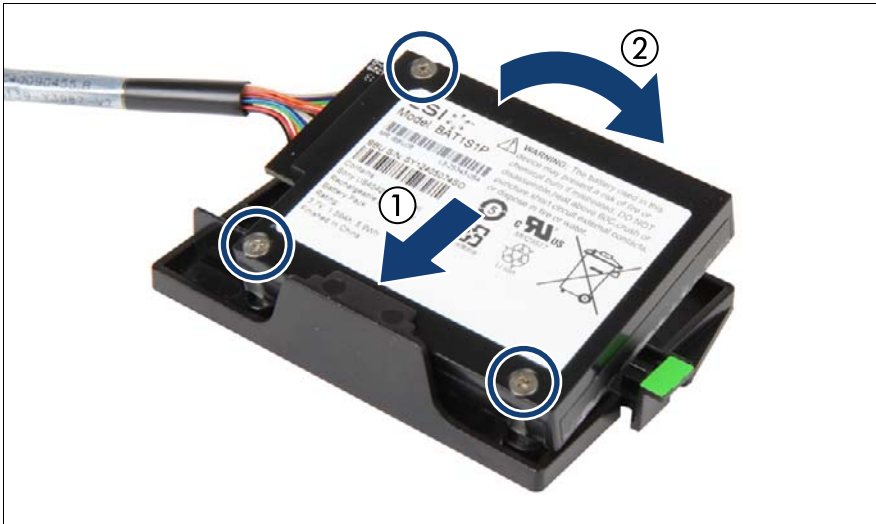

Figure 149: Installing the BBU in the BBU holder

- ▶ At a slight angle, fit the BBU under the right retaining bracket on the BBU holder (1).
- ▶ Fold down the BBU until it locks in place (2).

9.5.2.4 Installing the BBU with the holder

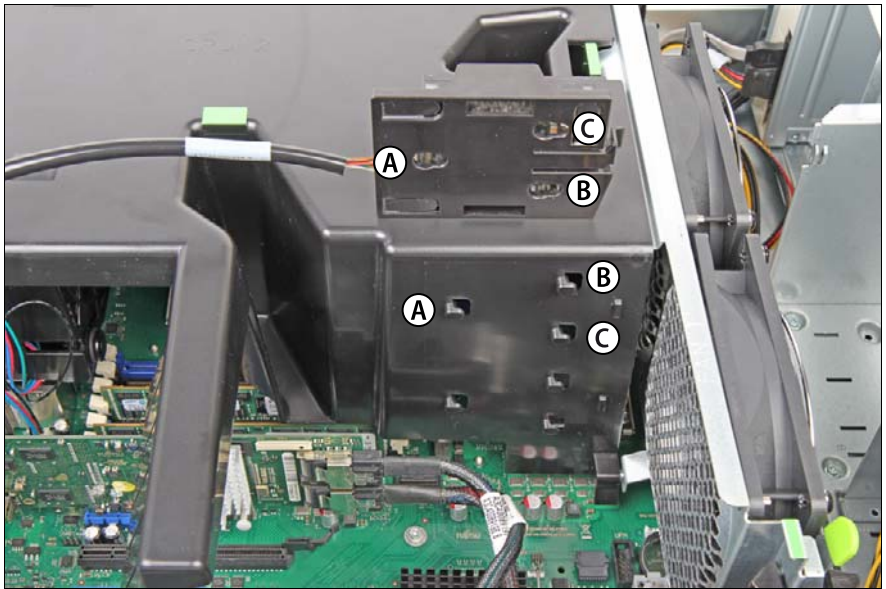

Figure 150: Mounting the BBU holder (A)

i Note the positions of the fixation bolts on the side of the system air duct and corresponding keyhole slots on the BBU holder.

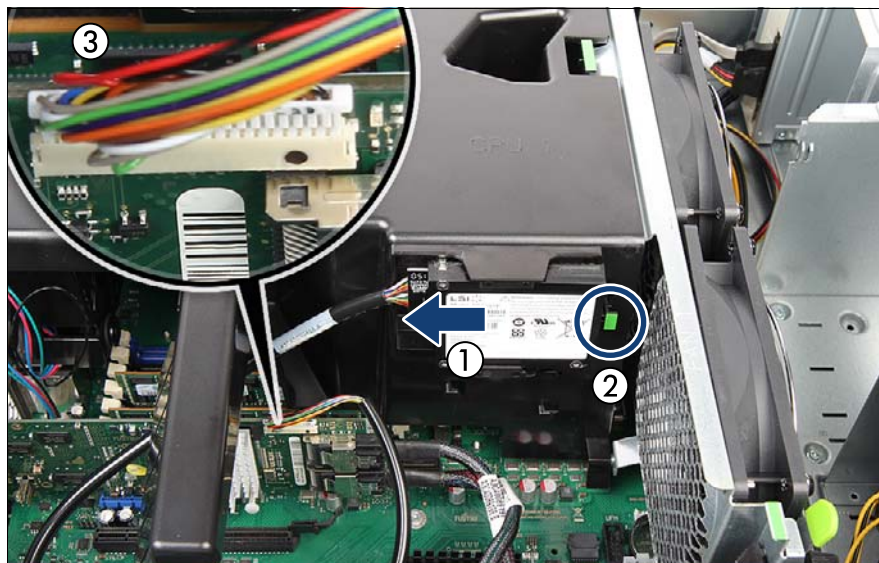

Figure 151: Mounting the BBU holder (B)

- ▶ Insert the BBU holder into the chassis so that the three hooks on the air duct rest in the wide ends of the keyhole slots on the BBU holder.
- ▶ Slide the BBU holder in as far as it will go (1).
The hooks on the air duct will lock in the narrow ends of the keyhole slots on the BBU holder.
- ▶ Ensure that the locking handle on the BBU holder properly snaps in place (2).
- ▶ If applicable, install a RAID controller as described in section ["Installing expansion cards" on page 208](#).
- ▶ Connect the BBU cable to the RAID controller (3, see close-up).



CAUTION!

Make sure that the connector side with the three dots points towards you. Otherwise, short-circuits may result!

9.5.2.5 Concluding steps

- ▶ ["Reassembling" on page 64](#)
- ▶ ["Connecting the server to the mains" on page 74](#)
- ▶ ["Switching on the server" on page 75](#)
- ▶ If applicable, ["Updating RAID controller firmware" on page 89](#)
- ▶ ["Enabling SVOM boot watchdog functionality" on page 94](#)

Note on BBU charging and calibration

The BBU may be deeply discharged due to extended storage time and wrongly show as bad or defective in the ServerView RAID Manager.

In this case, the BBU will automatically enter a trickle charge cycle for recovery. This initial charge may take up to 8 hours before the BBU will initiate a recalibration cycle.

- ▶ Enter the ServerView RAID Manager and check the current BBU status.



For further information, please refer to the "ServerView Suite RAID Management" user guide.

- ▶ If the BBU is shown as bad or defective, do not power off the server for at least 8 hours to allow the charge and calibration cycles to finish.
- ▶ If the BBU status does not change after 8 hours, please try to initiate the recalibration process manually using the ServerView RAID Manager.



If this procedure still does not fix the BBU status, please contact your local Fujitsu customer service partner.

9.5.3 Installing an FBU



Upgrade and Repair Unit (URU)



Hardware: 10 minutes

Tools: Phillips PH1 / (+) No. 1 screw driver



CAUTION!

For further safety information, please refer to chapter "[Important information](#)" on page 35.

9.5.3.1 Preliminary steps

- ▶ "[Disabling SVOM boot watchdog functionality](#)" on page 80
- ▶ "[Shutting down the server](#)" on page 50
- ▶ "[Disconnecting the server from the mains](#)" on page 50
- ▶ "[Getting access to the component](#)" on page 51

9.5.3.2 Installing TFM to the RAID controller (if applicable)

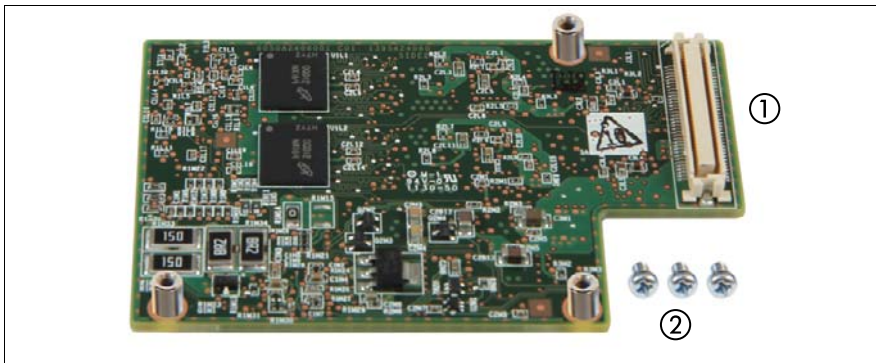

Figure 152: TFM kit

1	TFM	2	Screws
---	-----	---	--------

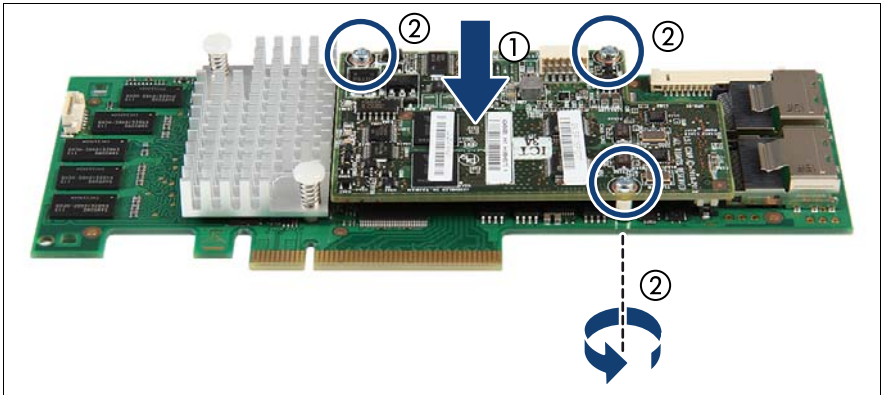

Figure 153: Installing TFM

- ▶ Fit the spacer bolts of the TFM on the RAID controller (1).
- ▶ Secure the TFM on the RAID controller with the three screws (2).

9.5.3.3 Installing the FBU in the holder

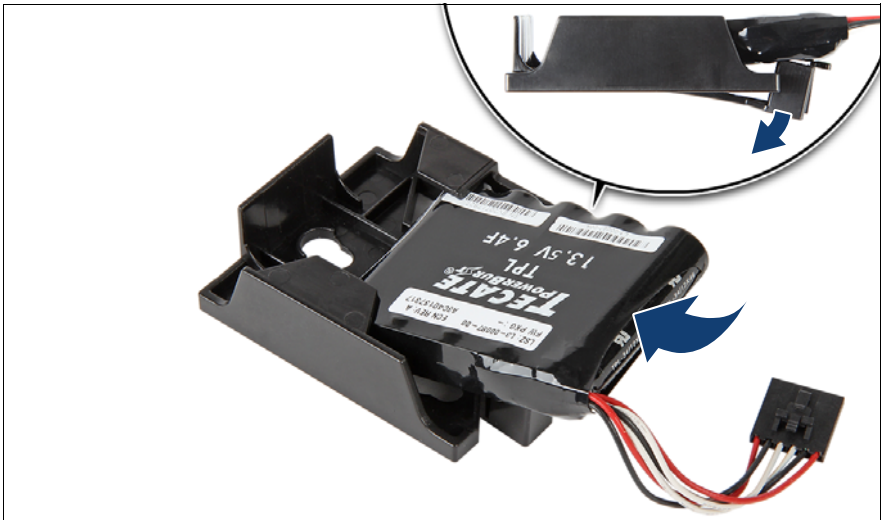

Figure 154: Installing the FBU in the holder (A)

- ▶ At a slight angle, fit the FBU under the right retaining bracket on the holder.
- ▶ Push down the FBU until it locks in place.

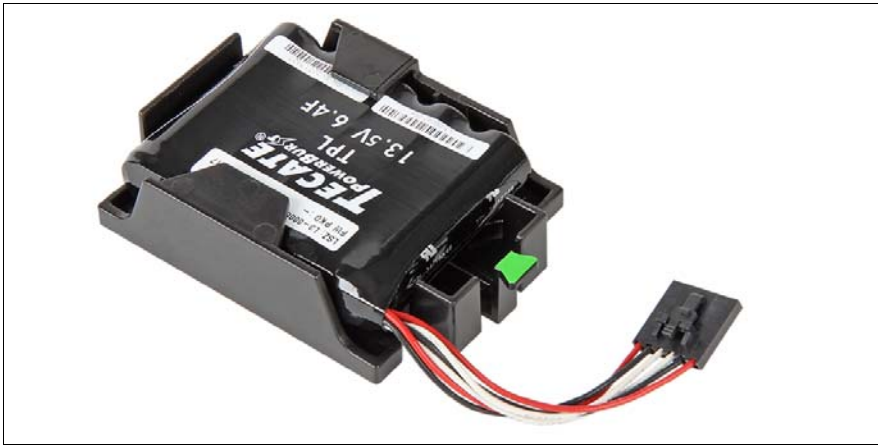

Figure 155: Installing the FBU in the holder (B)

- ▶ Ensure that the FBU is properly seated in the holder.

9.5.3.4 Connecting the FBU cable to the FBU

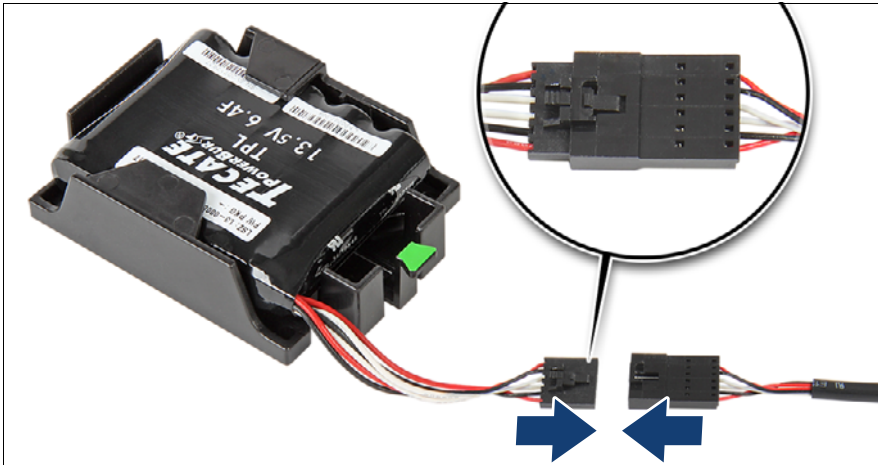

Figure 156: Connecting the FBU cable

- ▶ Connect the FBU cable to the FBU.

9.5.3.5 Installing the FBU with the holder

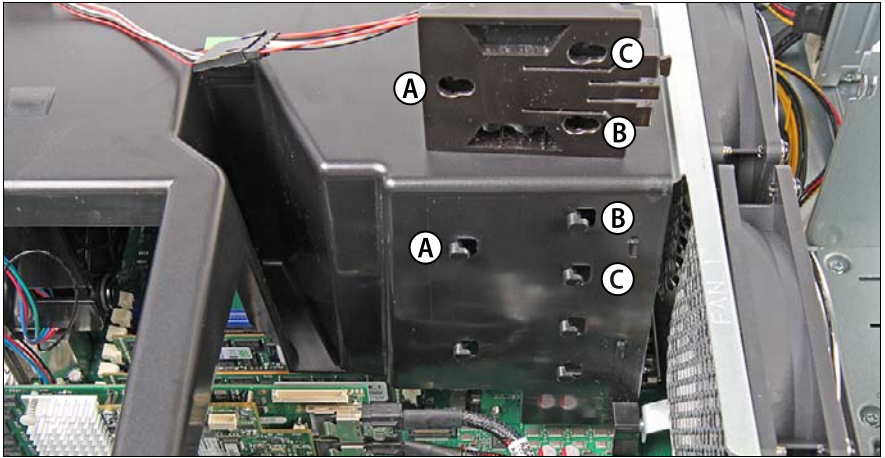

Figure 157: Mounting the FBU holder (A)

i Note the positions of the fixation bolts on the side of the system air duct (A-C) and corresponding keyhole slots on the FBU holder.

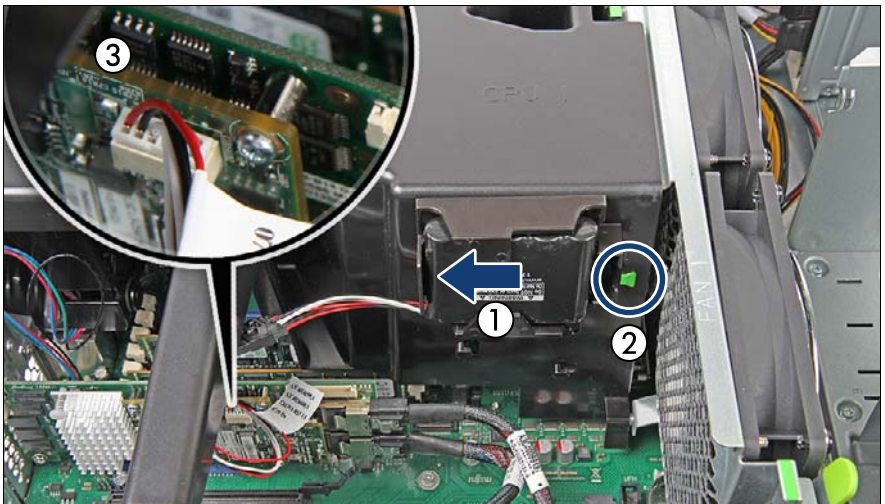

Figure 158: Mounting the FBU holder (B)

- ▶ Insert the FBU holder into the chassis so that the three hooks on the air duct rest in the wide ends of the keyhole slots on the FBU holder.

Expansion cards and backup units

- ▶ Slide the FBU holder in as far as it will go (1).
The hooks on the air duct will lock in the narrow ends of the keyhole slots on the FBU holder.
- ▶ Ensure that the locking handle on the FBU holder properly snaps in place (2).
- ▶ If applicable, install a RAID controller as described in section ["Installing expansion cards" on page 208](#).
- ▶ Connect the FBU cable to the TFM (3, see close-up).

9.5.3.6 Concluding steps

- ▶ ["Reassembling" on page 64](#)
- ▶ ["Connecting the server to the mains" on page 74](#)
- ▶ ["Switching on the server" on page 75](#)
- ▶ If applicable, ["Updating RAID controller firmware" on page 89](#)
- ▶ ["Enabling SVOM boot watchdog functionality" on page 94](#)

9.5.4 Removing a BBU



Upgrade and Repair Unit (URU)



Hardware: 5 minutes

Tools: tool-less



CAUTION!

Do not throw battery backup units into the trash can. Batteries must be disposed of in accordance with local regulations concerning special waste.

For further safety information, please refer to section ["Environmental protection" on page 44](#).

9.5.4.1 Preliminary steps

- ▶ "Disabling SVOM boot watchdog functionality" on page 80
- ▶ "Shutting down the server" on page 50
- ▶ "Disconnecting the server from the mains" on page 50
- ▶ "Getting access to the component" on page 51

9.5.4.2 Removing the BBU with the holder

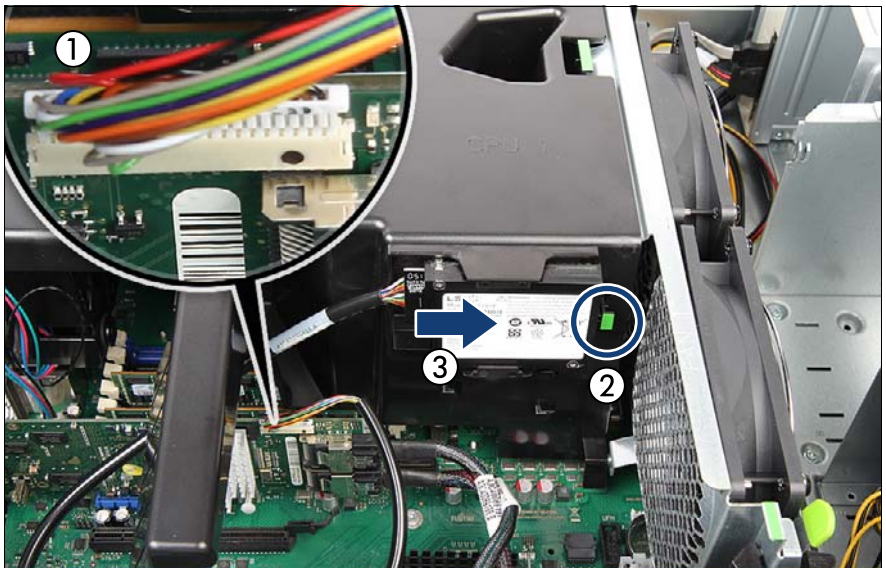

Figure 159: Removing the BBU holder from the chassis

- ▶ Carefully disconnect the BBU cable from the RAID controller (1).
- ▶ Lift up the green locking handle on the BBU holder (2, see close-up) while sliding the BBU holder in the direction of the arrow as far as it will go (3).



After that, the hooks on the air duct will rest in the wide ends of the keyhole slots on the holder.

- ▶ Lift the BBU holder out of the chassis.

9.5.4.3 Removing the BBU from the holder

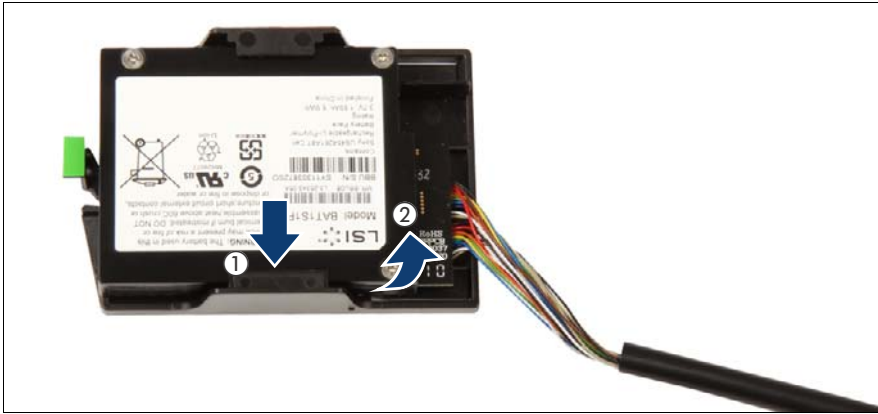

Figure 160: Removing the BBU from the holder

- ▶ Press out on the retaining bracket on the holder (1), lift the battery at the bottom side and remove the BBU at a slight angle out of the holder (2).

9.5.4.4 Disconnecting the BBU cable from the BBU

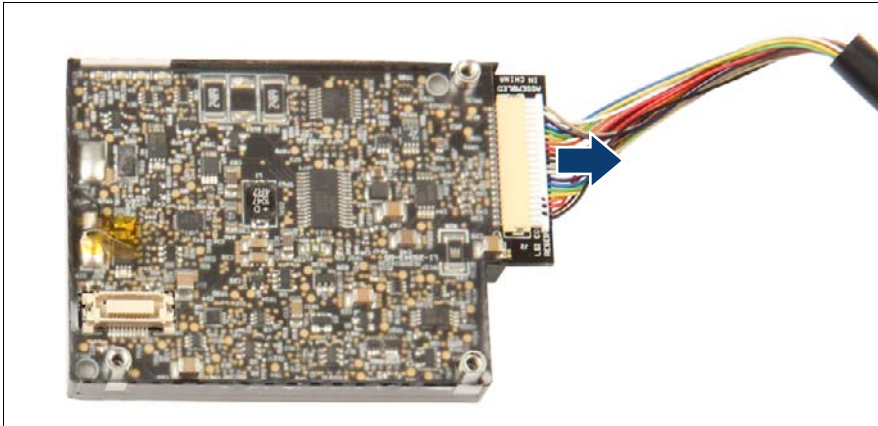

Figure 161: Disconnecting the BBU cable from the BBU

- ▶ Disconnect the BBU cable from the BBU.

9.5.4.5 Concluding steps

- ▶ ["Reassembling" on page 64](#)
- ▶ ["Connecting the server to the mains" on page 74](#)
- ▶ ["Switching on the server" on page 75](#)
- ▶ If applicable, ["Updating RAID controller firmware" on page 89](#)
- ▶ ["Enabling SVOM boot watchdog functionality" on page 94](#)

9.5.5 Removing an FBU



Upgrade and Repair Unit (URU)



Hardware: 5 minutes

Tools: tool-less



CAUTION!

Do not throw FBUs into the trash can. Batteries must be disposed of in accordance with local regulations concerning special waste.

For further safety information, please refer to section ["Environmental protection" on page 44](#).

9.5.5.1 Preliminary steps

- ▶ ["Disabling SVOM boot watchdog functionality" on page 80](#)
- ▶ ["Shutting down the server" on page 50](#)
- ▶ ["Disconnecting the server from the mains" on page 50](#)
- ▶ ["Getting access to the component" on page 51](#)

9.5.5.2 Removing the FBU with the holder

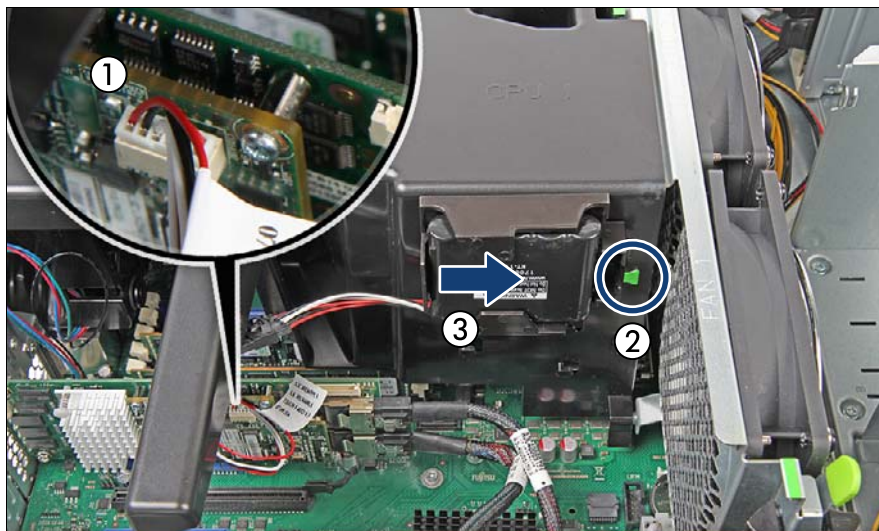

Figure 162: Removing the FBU holder from the chassis

- ▶ Carefully disconnect the FBU cable from the RAID controller (1).
- ▶ Lift up the green locking handle on the FBU holder (2) while sliding the FBU holder in the direction of the arrow as far as it will go (3).



After that, the hooks on the air duct will rest in the wide ends of the keyhole slots on the holder.

- ▶ Lift the FBU holder out of the chassis.

9.5.5.3 Disconnecting the FBU cable from the FBU

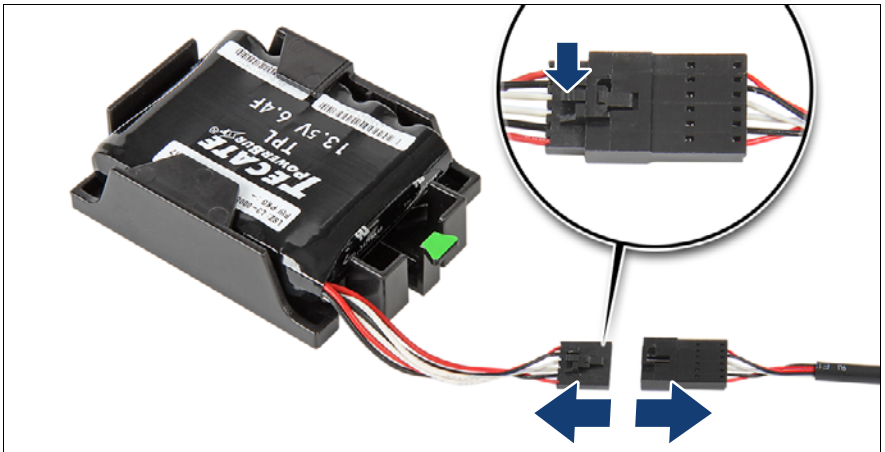

Figure 163: Disconnecting the FBU cable from the FBU

- ▶ Disconnect the FBU cable from the FBU.

9.5.5.4 Removing the FBU from the holder

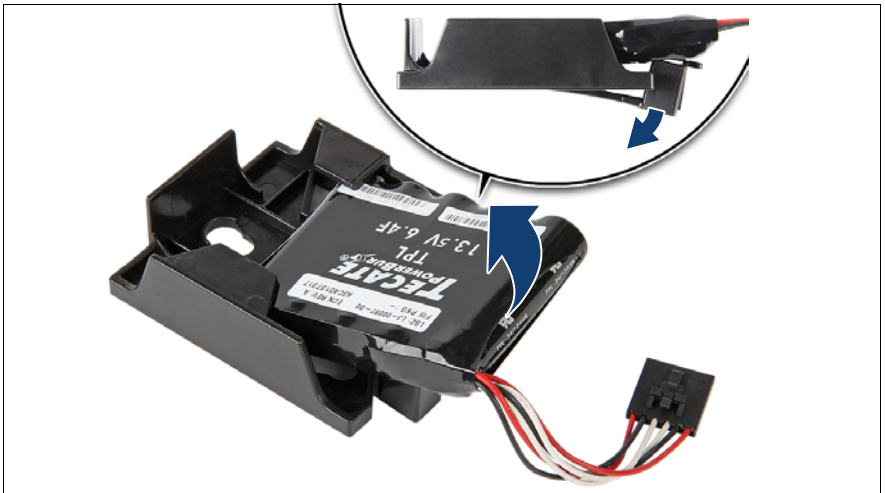

Figure 164: Removing the FBU from the holder

- ▶ Pull the FBU at a slight angle out of the holder.

9.5.5.5 Concluding steps

- ▶ ["Reassembling" on page 64](#)
- ▶ ["Connecting the server to the mains" on page 74](#)
- ▶ ["Switching on the server" on page 75](#)
- ▶ If applicable, ["Updating RAID controller firmware" on page 89](#)
- ▶ ["Enabling SVOM boot watchdog functionality" on page 94](#)

9.5.6 Replacing a BBU



Upgrade and Repair Unit (URU)



Hardware: 10 minutes

Tools: tool-less



CAUTION!

Do not throw battery backup units into the trash can. Batteries must be disposed of in accordance with local regulations concerning special waste.

For further safety information, please refer to section ["Environmental protection" on page 44](#).

9.5.6.1 Preliminary steps

- ▶ ["Locating the defective server" on page 47](#)
- ▶ ["Disabling SVOM boot watchdog functionality" on page 80](#)
- ▶ ["Shutting down the server" on page 50](#)
- ▶ ["Disconnecting the server from the mains" on page 50](#)
- ▶ ["Getting access to the component" on page 51](#)

9.5.6.2 Removing the defective BBU

- ▶ Remove the BBU with the holder as described in section ["Removing the BBU with the holder"](#) on page 231.
- ▶ Remove the BBU from the holder as described in section ["Removing the BBU from the holder"](#) on page 232.
- ▶ Disconnect the BBU cable as described in section ["Disconnecting the BBU cable from the BBU"](#) on page 232.

9.5.6.3 Installing the new BBU

- ▶ Connect the BBU cable to the BBU as described in section ["Connecting the BBU cable to the BBU"](#) on page 221.
- ▶ Install the new BBU in the BBU holder as described in section ["Installing the BBU in the holder"](#) on page 222.
- ▶ Install the BBU with the holder as described in section ["Installing the BBU with the holder"](#) on page 223.

9.5.6.4 Concluding steps

- ▶ ["Reassembling"](#) on page 64
- ▶ ["Connecting the server to the mains"](#) on page 74
- ▶ ["Switching on the server"](#) on page 75
- ▶ If applicable, ["Updating RAID controller firmware"](#) on page 89
- ▶ ["Enabling SVOM boot watchdog functionality"](#) on page 94

Note on BBU charging and calibration

The BBU may be deeply discharged due to extended storage time and wrongly show as bad or defective in the ServerView RAID Manager.

In this case, the BBU will automatically enter a trickle charge cycle for recovery. This initial charge may take up to 8 hours before the BBU will initiate a recalibration cycle.

- ▶ Enter the ServerView RAID Manager and check the current BBU status.



For further information, please refer to the ["ServerView Suite RAID Management"](#) user guide.

Expansion cards and backup units

- ▶ If the BBU is shown as bad or defective, do not power off the server for at least 8 hours to allow the charge and calibration cycles to finish.
- ▶ If the BBU status does not change after 8 hours, please try to initiate the recalibration process manually using the ServerView RAID Manager.



If this procedure still does not fix the BBU status, please contact your local Fujitsu customer service partner.

9.5.7 Replacing an FBU



Upgrade and Repair Unit (URU)



Hardware: 10 minutes

Tools: tool-less



CAUTION!

Do not throw battery FBUs into the trash can. Batteries must be disposed of in accordance with local regulations concerning special waste.

For further safety information, please refer to section "[Environmental protection](#)" on page 44.

9.5.7.1 Preliminary steps

- ▶ "[Locating the defective server](#)" on page 47
- ▶ "[Disabling SVOM boot watchdog functionality](#)" on page 80
- ▶ "[Shutting down the server](#)" on page 50
- ▶ "[Disconnecting the server from the mains](#)" on page 50
- ▶ "[Getting access to the component](#)" on page 51

9.5.7.2 Removing the defective FBU

- ▶ Remove the FBU with the holder as described in section "[Removing the FBU with the holder](#)" on page 234.
- ▶ Disconnect the FBU cable from the FBU as described in section "[Disconnecting the FBU cable from the FBU](#)" on page 235.

- ▶ Remove the FBU from the holder as described in section ["Removing the FBU from the holder"](#) on page 235.

9.5.7.3 Installing the new FBU

- ▶ Install the new FBU in the holder as described in section ["Installing the BBU in the holder"](#) on page 222.
- ▶ Connect the FBU cable to the FBU as described in section ["Connecting the FBU cable to the FBU"](#) on page 228.
- ▶ Install the FBU with holder as described in section ["Installing the FBU with the holder"](#) on page 229.

9.5.7.4 Concluding steps

- ▶ ["Reassembling"](#) on page 64
- ▶ ["Connecting the server to the mains"](#) on page 74
- ▶ ["Switching on the server"](#) on page 75
- ▶ If applicable, ["Updating RAID controller firmware"](#) on page 89
- ▶ ["Enabling SVOM boot watchdog functionality"](#) on page 94

10 Main memory

Safety notes



CAUTION!

- Do not install unsupported third party memory modules. For further information on supported memory modules, refer to section "[Basic information](#)" on page 242.
- Memory modules remain hot after shutdown. Wait for components to cool down before installing or removing memory modules to prevent burns.
- Do not insert and remove memory modules repeatedly. Doing so may cause failures.
- Pressing out the securing clips on the memory slot will eject the installed memory module. To prevent damage and injuries eject memory modules carefully without applying excessive force.
- For further information, please refer to chapter "[Important information](#)" on page 35.

10.1 Basic information

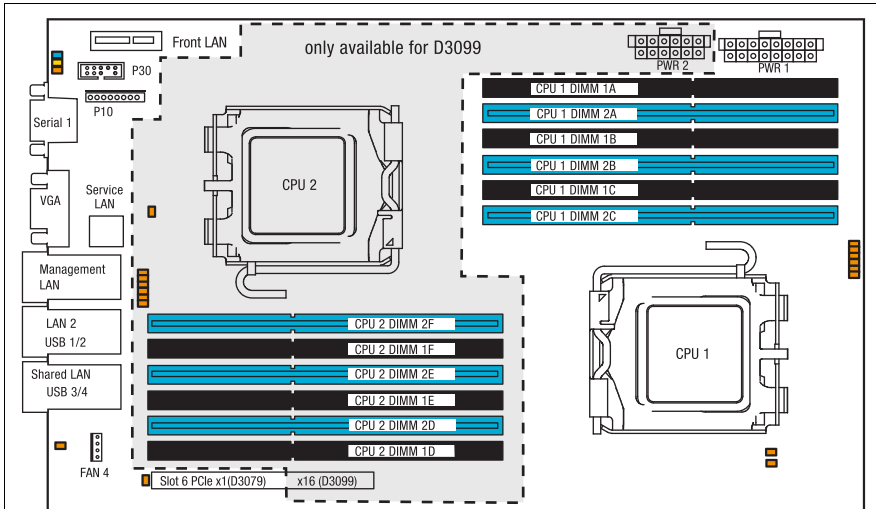

Figure 165: Memory overview

- The system board is equipped:
 - D3079 (TX150 S8): 6 memory slots
 - D3099 (TX200 S7): 12 memory slots (6 memory slots per CPU)
- The system has to be equipped with at least one memory module per CPU.
- Supported capacities: 2 GB, 4 GB, 8 GB, or 16 GB
- Maximum amount of RAM:
 - D3079 (TX150 S8): 96 GB
 - D3099 (TX200 S7): 192 GB
- Supported memory modules:
 - DDR3-1066 PC3-8500, DDR3-1333 PC3-10600 and DDR3-1600 PC3-12800

Type	Ranking		Error Correction
	SR	DR	
RDIMMs (Registered DIMMs)	o	o	ECC or non-ECC
UDIMMs (Unbuffered DIMMs)	o	o	ECC

10.1.1 Memory sequence

10.1.1.1 Population rules

- Populate memory slot 1 / channel A (DIMM 1A) first (except Mirrored Channel mode).
- In case of dual processor configurations, populate memory slot 1 / channel D (DIMM 1D) second (except Mirrored Channel mode).
- Within all channels, memory slot 1 must be populated prior to slot 2.
- If memory modules with different ranks are used, always populate the higher number rank DIMM first (starting from slot 1).
- If memory modules with different capacities are used:
 - Populate modules with higher capacities first.
 - Within a channel, populate modules in descending order of capacity.
- If memory modules with different speeds are used, the lowest clock rate applies for all DIMMs.
Regardless of the mode, all DIMMs will run at the highest common frequency that is allowed by the SPD Data of the DIMMs and the maximum speed of the selected configuration.
- Mixing UDIMMs or RDIMMs is not allowed.
- Mixing ECC and non-ECC DIMMs is not allowed.

Main memory

10.1.1.2 Independant Channel mode

CPU	CPU 1						CPU 2					
Channel	A		B		C		D		E		F	
DIMM	1A	2A	1B	2B	1C	2C	1D	2D	1E	2E	1F	2F
# DIMMs	Mono CPU configuration											
1	1											
2	1		2									
3	1		2		3							
4	1	4	2		3							
5	1	4	2	5	3							
6	1	4	2	5	3	6						
# DIMMs	Dual CPU configuration											
1	1						2					
2	1		3				2		4			
3	1		3		5		2		4		6	
4	1	7	3		5		2	8	4		6	
5	1	7	3	9	5		2	8	4	10	6	
6	1	7	3	9	5	11	2	8	4	10	6	12

10.1.1.3 Mirrored Channel mode

CPU	CPU 1						CPU 2					
Channel	A		B		C		D		E		F	
DIMM	1A	2A	1B	2B	1C	2C	1D	2D	1E	2E	1F	2F
# DIMMs	Mono CPU configuration											
2			1		1							
4			1	2	1	2						
# DIMMs	Dual CPU configuration											
4			1		1				2		2	
8			1	3	1	3			2	4	2	4

Notes on Mirrored Channel mode

- Always populate memory modules in multiples of 2.
- Same numbers mean identical modules (capacity, rank).

10.1.1.4 Performance mode

CPU	CPU 1						CPU 2					
Channel	A		B		C		D		E		F	
DIMM	1A	2A	1B	2B	1C	2C	1D	2D	1E	2E	1F	2F
# DIMMs	Mono CPU configuration											
6	1	2	1	2	1	2						
# DIMMs	Dual CPU configuration											
12	1	3	1	3	1	3	2	4	2	4	2	4

Notes on Performance mode

- Always populate memory modules in multiples of 3.
- Same numbers mean identical modules (capacity, rank).

10.1.1.5 Rank Sparring mode

Single-/Dual-Rank RDIMMs												
CPU	CPU 1						CPU 2					
Channel	A		B		C		D		E		F	
DIMM	1A	2A	1B	2B	1C	2C	1D	2D	1E	2E	1F	2F
# DIMMs	Mono CPU configuration											
2	1	1										
4	1	1	2	2								
6	1	1	2	2	3	3						
# DIMMs	Dual CPU configuration											
4	1	1					2	2				
8	1	1	3	3			2	2	4	4		
12	1	1	3	3	5	5	2	2	4	4	6	6

Main memory

Notes on Rank Sparing mode

- Same numbers mean identical modules (capacity, rank).
- In case of Single-/Dual-Rank memory configurations, at least two 1R or 2R modules must be populated per a channel.
- In order to satisfy cooling requirements, populate memory channels on alternating sides of the processor:

Order	CPU 1	CPU 2
1	Channel A	Channel D
2	Channel B	Channel E
3	Channel C	Channel F

10.2 Installing memory modules



Upgrade and Repair Unit (URU)



Hardware: 5 minutes

Tools: tool-less

10.2.1 Preliminary steps

- ▶ ["Disabling BitLocker functionality" on page 79](#)
- ▶ ["Disabling SVOM boot watchdog functionality" on page 80](#)
- ▶ ["Shutting down the server" on page 50](#)
- ▶ ["Disconnecting the server from the mains" on page 50](#)
- ▶ ["Getting access to the component" on page 51](#)

10.2.2 Installing a memory module

- ▶ Identify the correct memory slot see section ["Memory sequence" on page 243](#).



Figure 166: Installing memory modules (A)

- ▶ Press out the securing clip at each end of the memory slot.

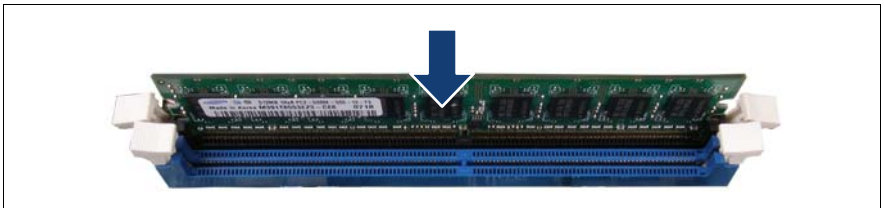

Figure 167: Installing memory modules (B)

- ▶ Align the notch on the bottom of the module with the crossbar in the slot.
- ▶ Press down on the memory module until the securing clips snap into the cutouts at each end of the module.

10.2.3 Concluding steps

- ▶ ["Reassembling" on page 64](#)
- ▶ ["Connecting the server to the mains" on page 74](#)
- ▶ ["Updating or recovering the system board BIOS and iRMC" on page 85](#) (if applicable)
- ▶ ["Switching on the server" on page 75](#)
- ▶ ["Enabling SVOM boot watchdog functionality" on page 94](#)
- ▶ ["Verifying the memory mode" on page 95](#) (if applicable)
- ▶ ["Enabling BitLocker functionality" on page 100](#)

10.3 Removing memory modules



Upgrade and Repair Unit
(URU)



Hardware: 5 minutes

Tools: tool-less

10.3.1 Preliminary steps

- ▶ ["Disabling BitLocker functionality" on page 79](#)
- ▶ ["Disabling SVOM boot watchdog functionality" on page 80](#)
- ▶ ["Locating the defective server" on page 47](#)
- ▶ ["Shutting down the server" on page 50](#)
- ▶ ["Disconnecting the server from the mains" on page 50](#)
- ▶ ["Getting access to the component" on page 51](#)

10.3.2 Removing a memory module

- ▶ Identify the desired memory slot see section ["Memory sequence" on page 243](#).



CAUTION!

Ensure to maintain an operational configuration when removing memory modules. For additional information, please refer to section ["Basic information" on page 242](#).

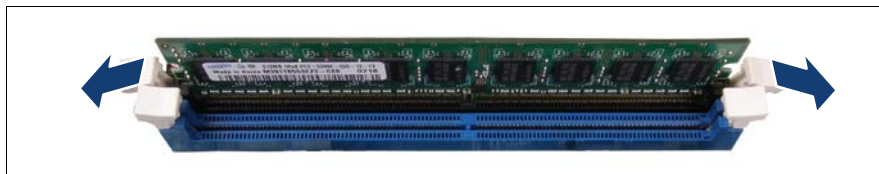

Figure 168: Removing memory modules (A)

- ▶ Eject the desired memory module by pressing out the securing clips at each end of the memory slot.

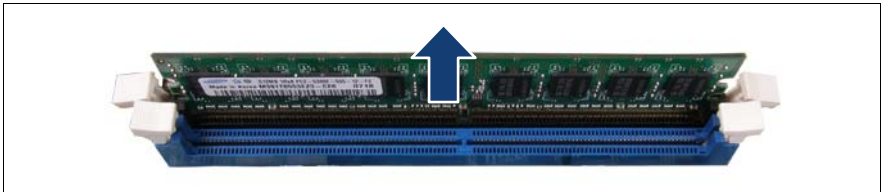

Figure 169: Removing memory modules (B)

- ▶ Remove the ejected memory module.

10.3.3 Concluding steps

- ▶ ["Reassembling" on page 64](#)
- ▶ ["Connecting the server to the mains" on page 74](#)
- ▶ ["Updating or recovering the system board BIOS and iRMC" on page 85](#) (if applicable)
- ▶ ["Switching on the server" on page 75](#)
- ▶ ["Enabling SVOM boot watchdog functionality" on page 94](#)
- ▶ ["Enabling BitLocker functionality" on page 100](#)

10.4 Replacing memory modules



**Upgrade and Repair Unit
(URU)**



**Hardware: 5 minutes
Software: 5 minutes**

Tools: tool-less

10.4.1 Preliminary steps

- ▶ Identify the defective memory slot using the server management software.
- ▶ ["Disabling BitLocker functionality" on page 79](#)
- ▶ ["Disabling SVOM boot watchdog functionality" on page 80](#)
- ▶ ["Locating the defective server" on page 47](#)

- ▶ ["Shutting down the server" on page 50](#)
- ▶ ["Disconnecting the server from the mains" on page 50](#)
- ▶ ["Getting access to the component" on page 51](#)
- ▶ Locate the defective memory module using the onboard Local Diagnostic LEDs as described in section ["Onboard indicators and controls" on page 419](#).

10.4.2 Removing the defective memory module

- ▶ Remove the memory module as described in section ["Removing a memory module" on page 248](#).

10.4.3 Installing the new memory module

- ▶ Install the memory module as described in section ["Installing a memory module" on page 247](#).

10.4.4 Concluding steps

- ▶ ["Reassembling" on page 64](#)
- ▶ ["Connecting the server to the mains" on page 74](#)
- ▶ ["Updating or recovering the system board BIOS and iRMC" on page 85](#) (if applicable)
- ▶ ["Switching on the server" on page 75](#)
- ▶ ["Enabling SVOM boot watchdog functionality" on page 94](#)
- ▶ ["Enabling replaced components in the system BIOS" on page 95](#)
- ▶ ["Verifying the memory mode" on page 95](#)
- ▶ ["Enabling BitLocker functionality" on page 100](#)

11 Processors

Safety notes



CAUTION!

- Do not install unsupported processors. For further information on supported processors, refer to section ["Basic information" on page 252](#).
- Circuit boards and soldered parts of internal options are exposed and can be damaged by static electricity. Always discharge static build-up (e.g. by touching a grounded object) before handling electrostatic-sensitive devices (ESDs)
- Do not touch the circuitry on boards or soldered parts. Hold circuit boards by their metallic areas or edges.
- When removing or installing processors, be careful not to touch or bend the spring contacts on the processor sockets.
- Never touch the underside of the processors. Even minor soiling such as grease from the skin can impair the processor's operation or destroy the processors.
- For further information, please refer to chapter ["Important information" on page 35](#).

11.1 Basic information

11.1.1 Supported processors

- Intel Xeon E5-2400 processor series CPUs
- Socket type: LGA 2011 package
- Thermal Design Power (TDP) class: up to 135 W

11.1.2 Processor locations

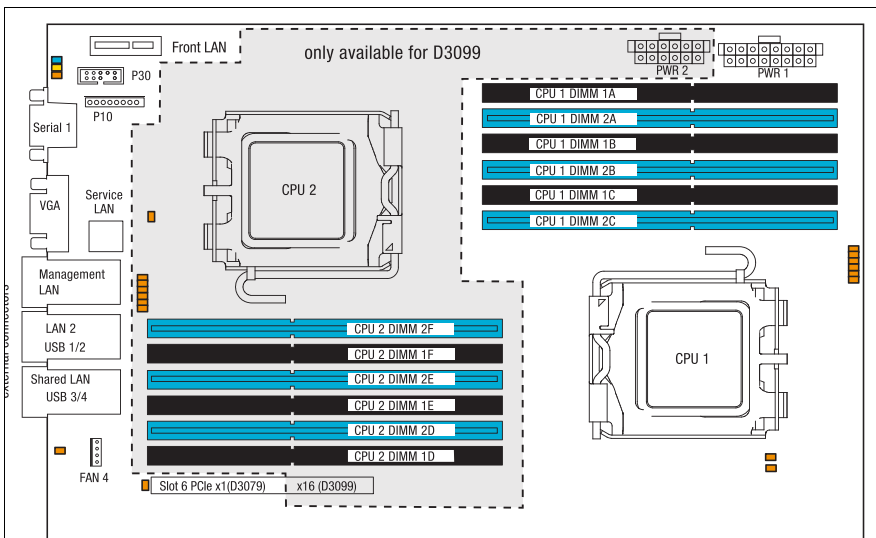

Figure 170: Processor locations on system board D3079 (TX150 S8) / D3099 (TX200 S7)

- The system board is equipped:
 - D3079 (TX150 S8): one processor (CPU 1)
 - D3099 (TX200 S7): two processors (CPU 1 and CPU 2)

11.2 Installing processors



Upgrade and Repair Unit (URU)



Hardware: 15 minutes
Software: 5 minutes

Tools: Phillips PH2 / (+) No. 2 screw driver



CAUTION!

Processors are extremely sensitive to electrostatic discharge and must be handled with care. After a processor has been removed from its protective sleeve or from its socket, place it upside down on a nonconducting, antistatic surface. Never push a processor over a surface.

11.2.1 Preliminary steps

- ▶ ["Disabling BitLocker functionality" on page 79](#)
- ▶ ["Disabling SVOM boot watchdog functionality" on page 80](#)
- ▶ ["Shutting down the server" on page 50](#)
- ▶ ["Disconnecting the server from the mains" on page 50](#)
- ▶ ["Getting access to the component" on page 51](#)

11.2.2 Installing a processor



This description applies to the following procedures:

- Installing the second processor in a single-processor configuration
- Transferring a processor after replacing the system board (see section ["Replacing the system board" on page 373](#))

11.2.2.1 Removing the protective cover

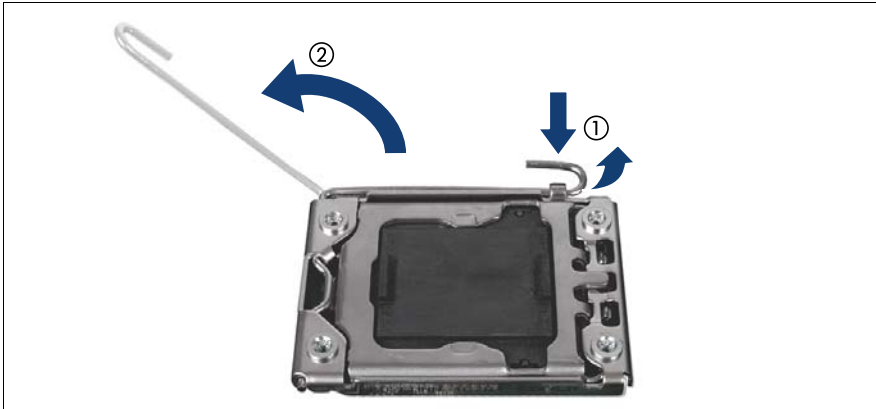

Figure 171: Opening socket release lever

- ▶ Unlatch the socket release lever by pushing it down and away from the socket (1) , and then swivel it up (2).

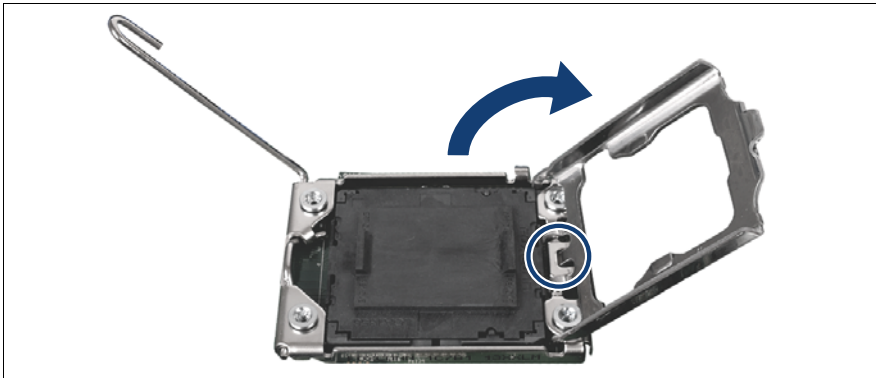

Figure 172: Opening the load plate

- ▶ Open the load plate of the processor socket.



CAUTION!

Handle the locking frame carefully.

In a vertical position, the small clip (see circle) can scratch the system board.

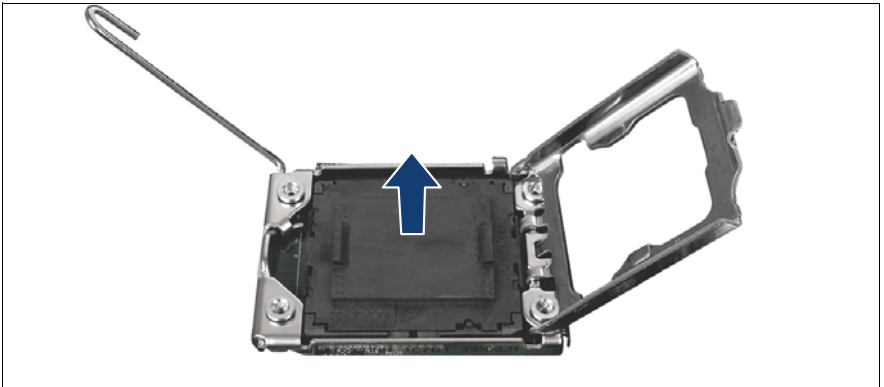

Figure 173: Removing the protective cover

- ▶ Remove the black protective cover from the processor socket.

11.2.2.2 Installing the new processor

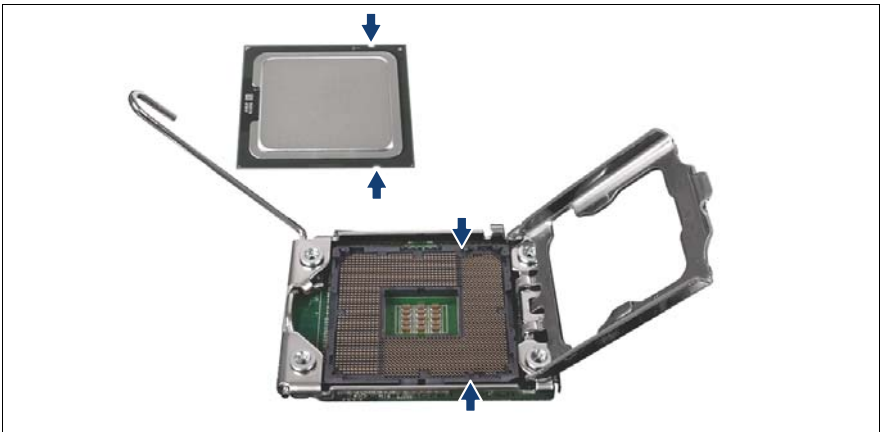

Figure 174: Installing the processor

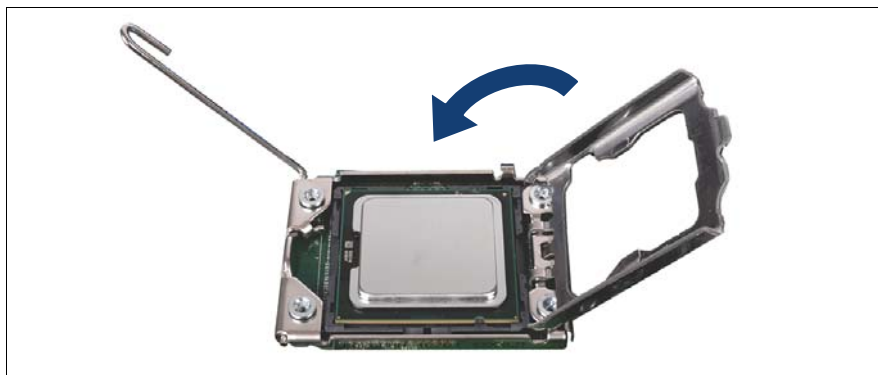

Figure 175: Closing the load plate

- ▶ Hold the processor with your thumb and index finger.
- ▶ Place the new processor on the socket.



Make sure that the recesses on the processor are aligned with the corresponding markings on the socket.



CAUTION!

- Ensure that the processor is level in the socket.
 - Be careful not to touch or bend the pins on the processor socket.
 - Never touch the underside of the processor. Even minor soiling such as grease from the skin can impair the processor's operation or destroy the processor.
 - Ensure not to scrape or dent the processor edges.
- ▶ Close the load plate of the processor.

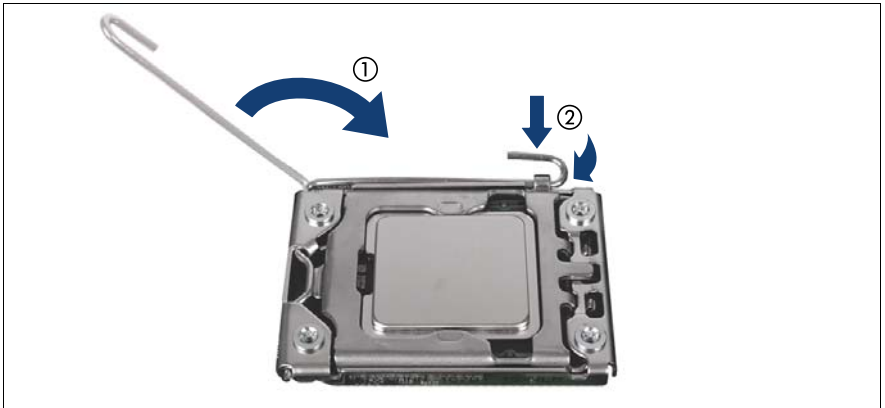

Figure 176: Closing the socket release lever

- ▶ Close the socket release lever (1) and latch it under the load plate retention tab (2) to lock down the load plate.
- ▶ If applicable, install the second processor accordingly.

11.2.3 Concluding steps

- ▶ ["Installing processor heat sinks" on page 266](#)
- ▶ ["Reassembling" on page 64](#)
- ▶ ["Connecting the server to the mains" on page 74](#)
- ▶ ["Switching on the server" on page 75](#)
- ▶ ["Updating or recovering the system board BIOS and iRMC" on page 85 \(if applicable\)](#)
- ▶ ["Enabling SVOM boot watchdog functionality" on page 94](#)
- ▶ ["Enabling BitLocker functionality" on page 100](#)

11.3 Removing processors



Upgrade and Repair Unit (URU)



Hardware: 15 minutes
Software: 5 minutes

Tools: Phillips PH2 / (+) No. 2 screw driver



CAUTION!

Processors are extremely sensitive to electrostatic discharge and must be handled with care. After a processor has been removed from its protective sleeve or from its socket, place it upside down on a nonconducting, antistatic surface. Never push a processor over a surface.

11.3.1 Preliminary steps

- ▶ ["Disabling BitLocker functionality" on page 79](#)
- ▶ ["Disabling SVOM boot watchdog functionality" on page 80](#)
- ▶ ["Shutting down the server" on page 50](#)
- ▶ ["Disconnecting the server from the mains" on page 50](#)
- ▶ ["Getting access to the component" on page 51](#)
- ▶ ["Removing processor heat sinks" on page 268](#)

11.3.2 Removing a processor



This description applies to the following procedures:

- Removing the second processor (CPU 2) from a dual-processor configuration
- Removing processors from a defective system board (see section ["Replacing the system board" on page 373](#))
- ▶ Remove the desired processor heat sink as described in section ["Removing processor heat sinks" on page 268](#).

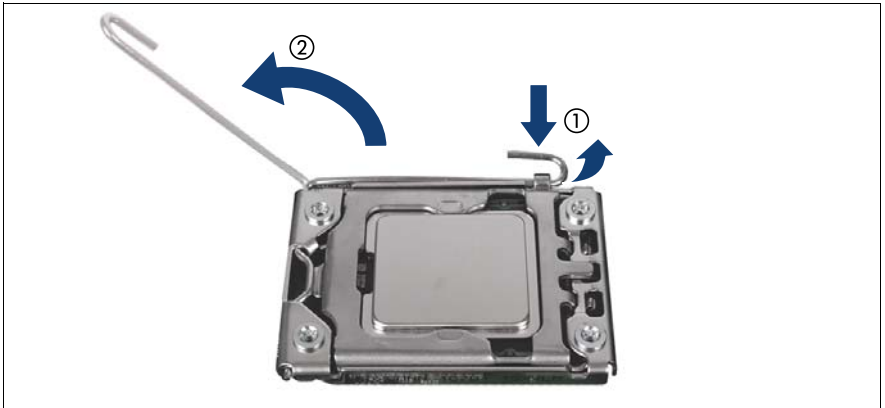

Figure 177: Opening socket release lever

- Unlatch the socket release lever by pushing it down and away from the socket (1), and then swivel it up (2).

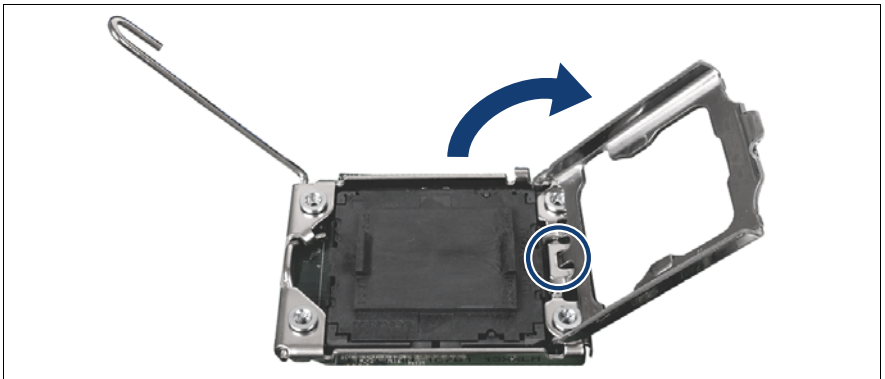

Figure 178: Opening the load plate

- Open the load plate of the processor socket.



CAUTION!

Handle the locking frame carefully.

In a vertical position, the small clip (see circle) can scratch the system board.

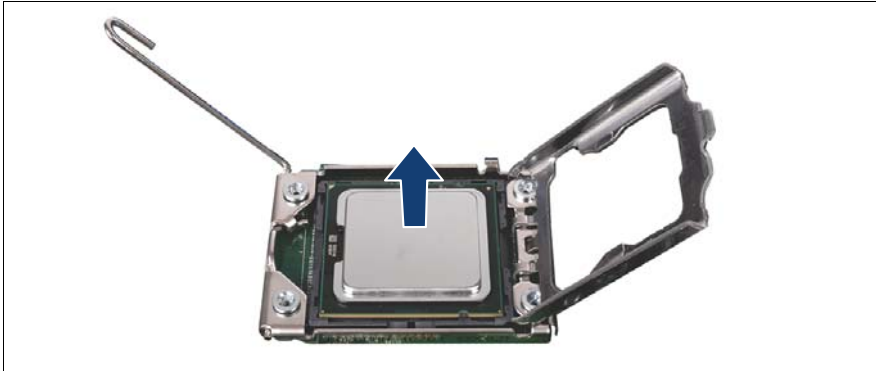

Figure 179: Removing the processor

- ▶ Carefully remove the defective processor from its socket in a vertical motion.



CAUTION!

Be careful not to touch or bend the spring contacts on the processor socket.

- ▶ Thoroughly clean residual thermal paste from the processor surface using a lint-free cloth.
- ▶ Store the processor in a safe place for later reuse.



CAUTION!

Processors are extremely sensitive to electrostatic discharge and must be handled with care. After a processor has been removed from its protective sleeve or from its socket, place it upside down on a nonconducting, antistatic surface. Never push a processor over a surface.

Be careful not to touch or bend the spring contacts on the processor socket.

11.3.2.1 Installing the protective cover

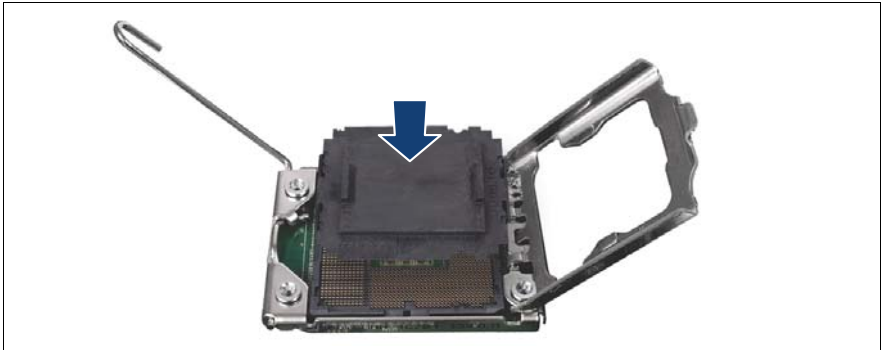

Figure 180: Attaching the protective socket cover

- ▶ Carefully lower the protective socket cover onto the processor socket in a vertical motion until it snaps in place.

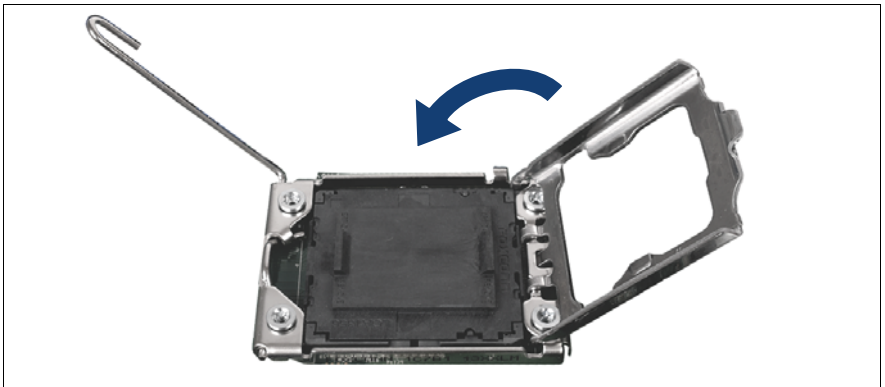

Figure 181: Closing the load plate

- ▶ Close the load plate of the processor.

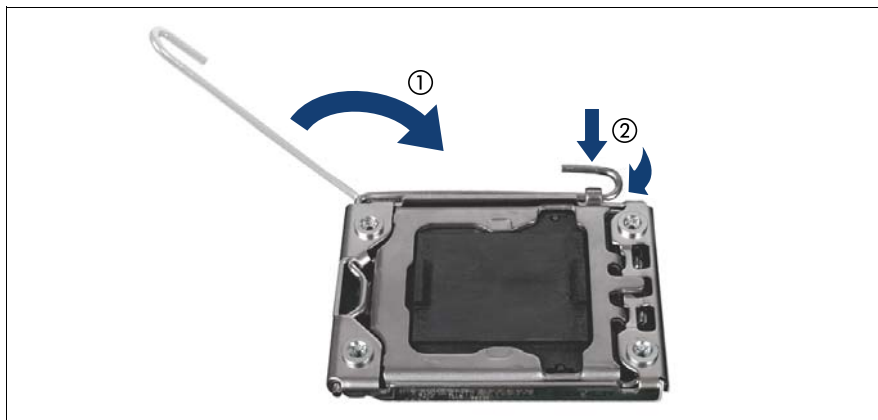

Figure 182: Close the socket release lever

- ▶ Close the socket release (1) lever and latch it under the load plate retention tab to lock down the load plate (2).

11.3.3 Concluding steps

- ▶ ["Reassembling" on page 64](#)
- ▶ ["Connecting the server to the mains" on page 74](#)
- ▶ If applicable, ["Updating or recovering the system board BIOS and iRMC" on page 85](#)
- ▶ ["Switching on the server" on page 75](#)
- ▶ ["Enabling SVOM boot watchdog functionality" on page 94](#)
- ▶ ["Enabling BitLocker functionality" on page 100](#)

11.4 Upgrading or replacing processors



Field Replaceable Unit (FRU)



Hardware: 15 minutes
Software: 5 minutes

Tools: Phillips PH2 / (+) No. 2 screw driver



CAUTION!

Processors are extremely sensitive to electrostatic discharge and must be handled with care. After a processor has been removed from its protective sleeve or from its socket, place it upside down on a nonconducting, antistatic surface. Never push a processor over a surface.

11.4.1 Preliminary steps

- ▶ ["Disabling BitLocker functionality" on page 79](#)
- ▶ ["Disabling SVOM boot watchdog functionality" on page 80](#)
- ▶ If applicable, ["Locating the defective server" on page 47](#)
- ▶ ["Shutting down the server" on page 50](#)
- ▶ ["Disconnecting the server from the mains" on page 50](#)
- ▶ ["Getting access to the component" on page 51](#)
- ▶ ["Removing processor heat sinks" on page 268](#)

11.4.2 Upgrading or replacing a processor



This description applies to the following procedures:

- Installing the second processor in a single-processor configuration
 - Transferring a processor after replacing the system board (see section ["Replacing the system board" on page 373](#))
- ▶ In case of installing a second processor remove the protective cover as described in section ["Removing the protective cover" on page 254](#).

- ▶ Remove the desired processor as described in section ["Removing a processor" on page 258](#).
- ▶ Install the new processor as described in section ["Installing a processor" on page 253](#).
- ▶ In case of transferring a processor install the protective cover to the defective system board as described in section ["Installing the protective cover" on page 261](#).

11.4.3 Concluding steps

- ▶ ["Installing processor heat sinks" on page 266](#)
- ▶ ["Reassembling" on page 64](#)
- ▶ ["Connecting the server to the mains" on page 74](#)
- ▶ ["Updating or recovering the system board BIOS and iRMC" on page 85](#) (if applicable)
- ▶ ["Switching on the server" on page 75](#)
- ▶ ["Enabling SVOM boot watchdog functionality" on page 94](#)
- ▶ ["Enabling BitLocker functionality" on page 100](#)

11.5 Handling processor heat sinks



Field Replaceable Unit (FRU)
if thermal paste is involved



Hardware: 15 minutes



Upgrade and Repair Unit (URU)

Tools: Phillips PH2 / (+) No. 2 screw driver

11.5.1 Preliminary steps

- ▶ ["Shutting down the server" on page 50](#)
- ▶ ["Disconnecting the server from the mains" on page 50](#)
- ▶ ["Getting access to the component" on page 51](#)

11.5.2 Installing processor heat sinks

11.5.2.1 Preparing the heat sink and processor

When installing a new heat sink

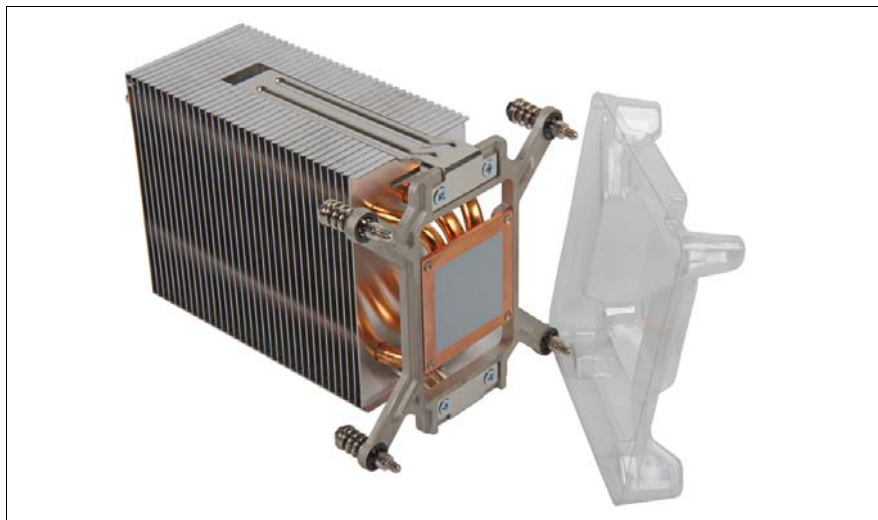

Figure 183: Removing the protective heat sink cover

- ▶ Remove the protective cover from the heat sink.



CAUTION!

Ensure not to touch the thermal paste on the bottom of the heat sink.

When reusing a heat sink

- ▶ Ensure that all residual thermal paste has been thoroughly cleaned off the copper surface of the heat sink.
- ▶ Apply thermal paste to the processor surface as described in section ["Applying thermal paste" on page 270](#).

11.5.2.2 Installing the heat sink

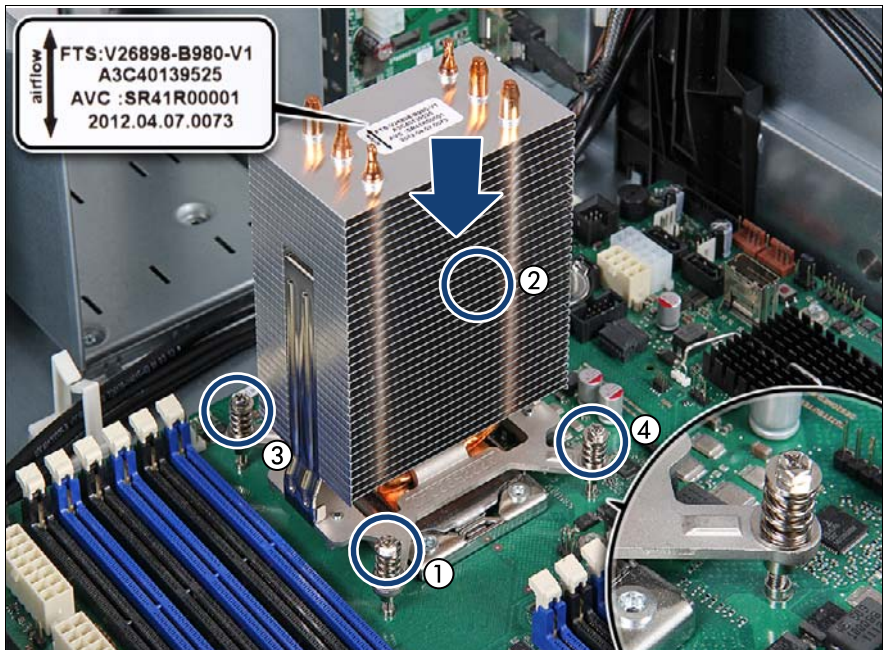

Figure 184: Installing the heat sink

- ▶ Align the heat sink as shown with the cooling fins matching the direction of the airflow (see airflow label).
- ▶ Carefully seat the heat sink on the four threaded holes as shown (see close-up).
- ▶ Fasten the four captive screws on the heat sink in a crossover pattern (screw torque: 1.0 Nm, not applicable for the Japanese market) (1-4).

11.5.3 Removing processor heat sinks

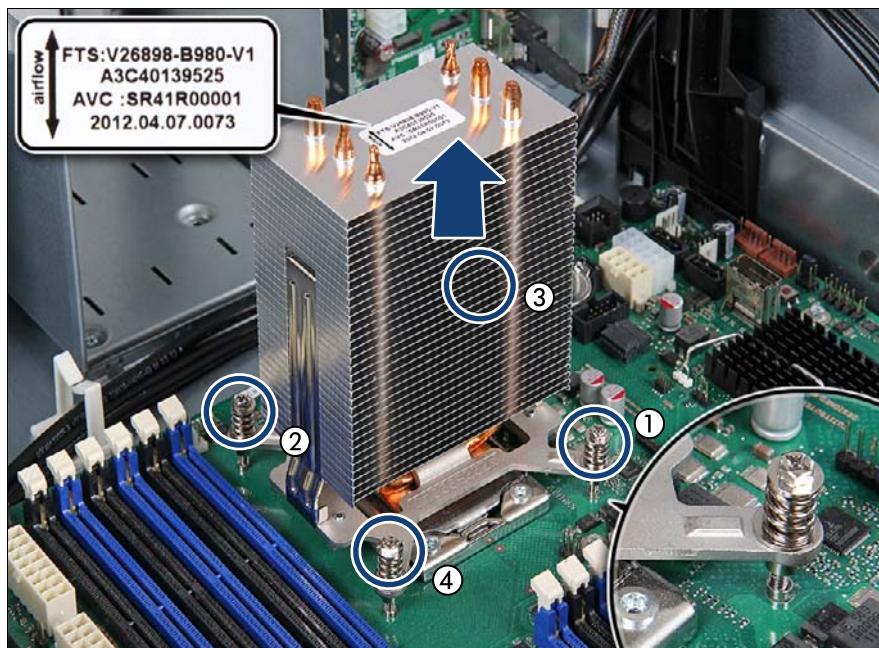

Figure 185: Removing the processor heat sink

- ▶ Loosen the four captive screws on the heat sink in a crossover pattern (1-4).
- ▶ Carefully turn the heat sink back and forth to detach it from the processor.



This may be necessary due to the adhesive quality of the thermal paste located between the heat sink and processor.



CAUTION!

Pay special attention not to damage any system board components surrounding the processor socket.

- ▶ Lift the heat sink out of the chassis.
- ▶ Thoroughly clean residual thermal paste from the surface of the heat sink and the processor using a lint-free cloth.

11.5.4 Replacing processor heat sinks

11.5.4.1 Removing the processor heat sink

- ▶ Remove the processor heat sink as described in section ["Removing processor heat sinks" on page 268](#).

11.5.4.2 Applying thermal paste

- ▶ Apply thermal paste to the processor surface as described in section ["Applying thermal paste" on page 270](#).



If the processor upgrade or replacement kit contains a new processor heat sink, a thin layer of thermal compound has already been pre-applied to its lower surface. In this case, please proceed with section ["Installing the processor heat sink" on page 269](#).

11.5.4.3 Installing the processor heat sink

- ▶ Install the processor heat sink as described in sections ["Preparing the heat sink and processor" on page 266](#) and ["Installing the heat sink" on page 267](#).

11.5.5 Concluding steps

- ▶ ["Reassembling" on page 64](#)
- ▶ ["Connecting the server to the mains" on page 74](#)
- ▶ ["Switching on the server" on page 75](#)

11.6 Applying thermal paste



Field Replaceable Unit (FRU)



Hardware: 5 minutes

Tools: tool-less



- For the Japanese market, the service engineer must follow the instruction provided separately.
- If the processor upgrade or replacement kit contains a new processor heat sink, a thin layer of thermal compound has already been pre-applied to its lower surface. In this case, please proceed with section ["Installing processor heat sinks" on page 266](#).

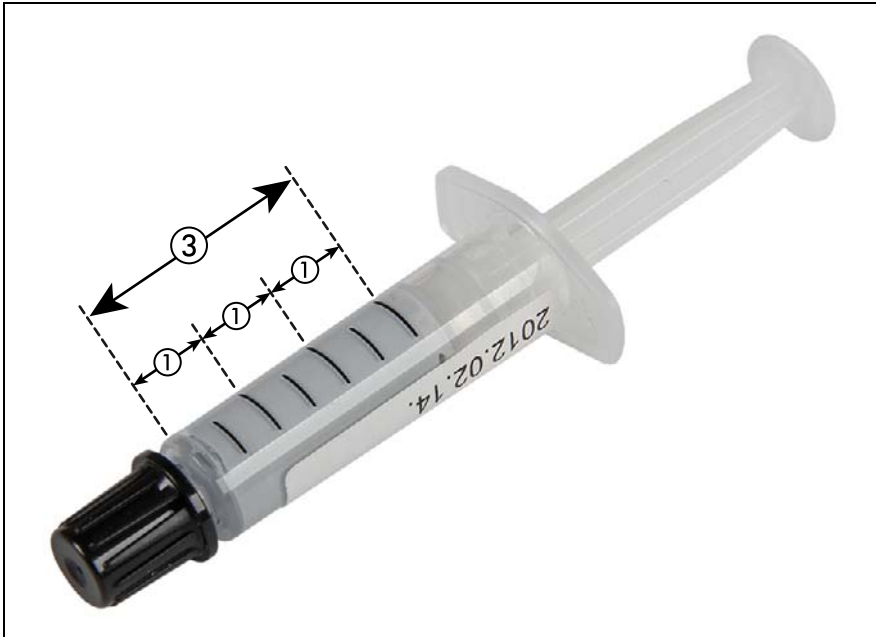

Figure 186: Thermal paste syringe

One thermal compound syringe (A3C40142460 / 34035576) contains thermal paste for three processors.

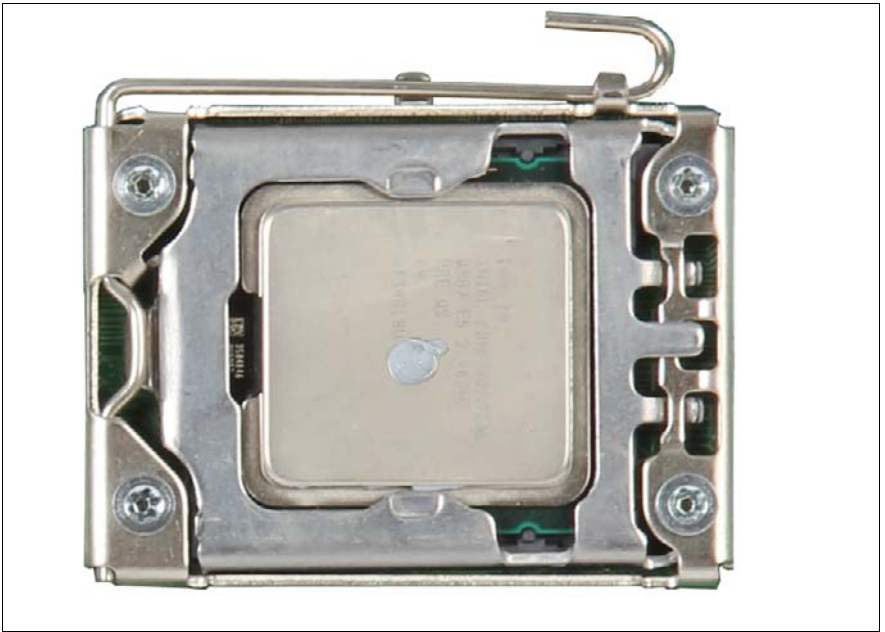

Figure 187: Applying thermal paste

- ▶ Apply a dot of thermal paste to the center of the processor surface as shown.



Two graduation marks on the syringe equal the correct amount of thermal paste for one processor.



CAUTION!

Do not mix different types of thermal paste.

12 Accessible drives and LSD

Safety notes



CAUTION!

- Before installing an accessible drive, acquaint yourself with the drive's user documentation.
- When inserting an accessible drive into the server, ensure not to pinch or strain any connected cables.
- When installing an accessible drive, hold it by its sides. Applying force to the top of the casing may cause failures.
- When disposing of, transferring, or returning a backup drive, ensure that all backup media has been removed from the drive.
- Do not touch the circuitry on boards or soldered parts. Hold circuit boards by their metallic areas or edges.
- Circuit boards and soldered parts of internal options are exposed and can be damaged by static electricity. Always discharge static build-up (e.g. by touching a grounded object) before handling electrostatic-sensitive devices (ESDs).
- For further safety information, please refer to chapter ["Important information" on page 35](#).

12.1 Basic information

Accessible drive bays

PRIMERGY TX150 S8 / TX200 S7 server offers three 5.25-inch accessible drive bays for optical disk drives and backup drives:

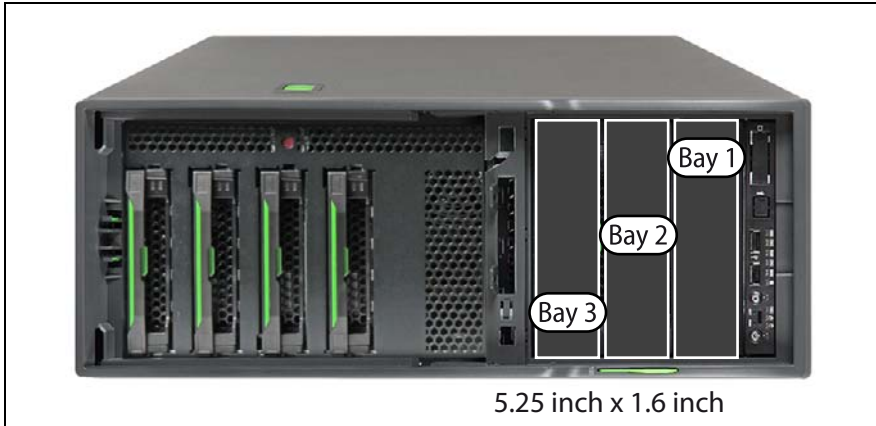

Figure 188: Accessible drives mounting order (tower server)

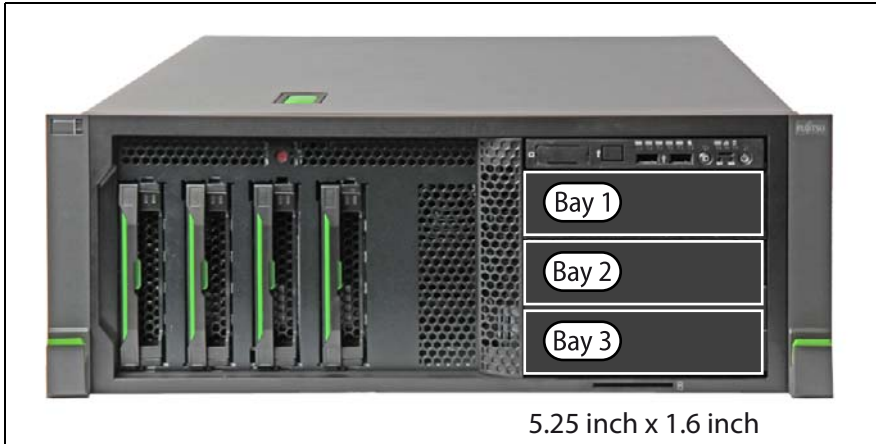

Figure 189: Accessible drives mounting order (rack server)

Mounting order for accessible drives

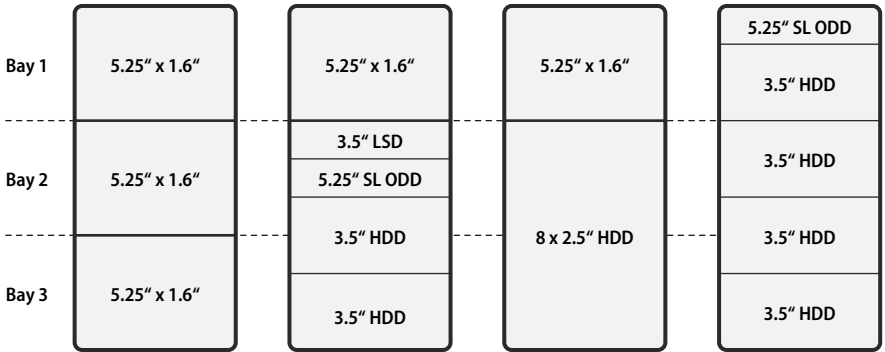

Figure 190: Accessible drive configurations

Order	Accessible drive	Drive bay	Max.	Occupied	Interface
1	4x 3.5-inch HDD extension box	Bays 1+2+3	1	4.8" x 5.25"	SAS
	Slimline ODD in 4x 3.5-inch HDD extension box				SATA
1	2x 3.5-inch HDD extension box	Bays 2+3	1	3.2" x 5.25"	SAS
	LSD in 2x 3.5-inch HDD extension box				i ² C bus
	Slimline ODD in 2x 3.5-inch HDD extension box				SATA
1	8x 2.5-inch HDD extension box	Bays 2+3	1	3.2" x 5.25"	SAS
2	LSD in Multibay box	Bay 1	1	1.6" x 5.25"	i ² C bus
	Slimline ODD in Multibay box				SATA
3	Optical disk drive (full height)	Bay 1, 2 or 3	1	1.6" x 5.25"	SATA

Table 4: Accessible drive mounting sequence

Accessible drives and LSD

Order	Accessible drive	Drive bay	Max.	Occupied	Interface
3	Backup drive LTO3 HH Ultrium	Bay 1, 2 or 3	1	1.6" x 5.25"	SAS
3	Backup drive LTO4 HH IBM	Bay 1, 2 or 3	1	1.6" x 5.25"	SAS
3	Backup drive LTO5 HH Ultrium	Bay 1, 2 or 3	1	1.6" x 5.25"	SAS
3	Backup drive DDS Gen 5 (DAT72)/ Gen 6 (DAT160)	Bay 1, 2 or 3	2	1.6" x 5.25"	USB 2.0
3	Backup drive DDS Gen 6 (DAT160)	Bay 1, 2 or 3	2	1.6" x 5.25"	USB 2.0
3	RDX backup drive	Bay 1, 2 or 3	2	1.6" x 5.25"	USB 2.0

Table 4: Accessible drive mounting sequence

12.2 Installing accessible drives



Upgrade and Repair Unit
(URU)



Hardware: 10 minutes

Tools: Slotted screw driver (for bending in or out accessible drive mounting brackets)

12.2.1 Preliminary steps

- ▶ ["Shutting down the server" on page 50](#)
- ▶ ["Disconnecting the server from the mains" on page 50](#)
- ▶ ["Getting access to the component" on page 51](#)



The front cover only needs to be removed in order to remove or install accessible drive dummy covers.

- ▶ ["Removing the system fan holder" on page 76](#)

12.2.2 Removing accessible drive dummy covers

- ▶ If applicable, remove the accessible dummy covers for the desired accessible drive bay as described in section ["Removing accessible drive dummy covers" on page 171](#).

12.2.3 Installing mounting brackets to RDX and DAT72 backup drives

Backup drive mounting brackets are contained in mounting kit S26361-F3753-E1 (to be ordered separately with the backup drive).



Replacing mounting brackets may be skipped in case of the following situations:

- Existing mounting brackets have been fitted with Torx screws (Japanese market only).
- No new mounting brackets are available when replacing a backup drive during service.

Accessible drives and LSD

- ▶ If applicable, remove existing mounting brackets from the backup drive.



Figure 191: Backup drive mounting brackets

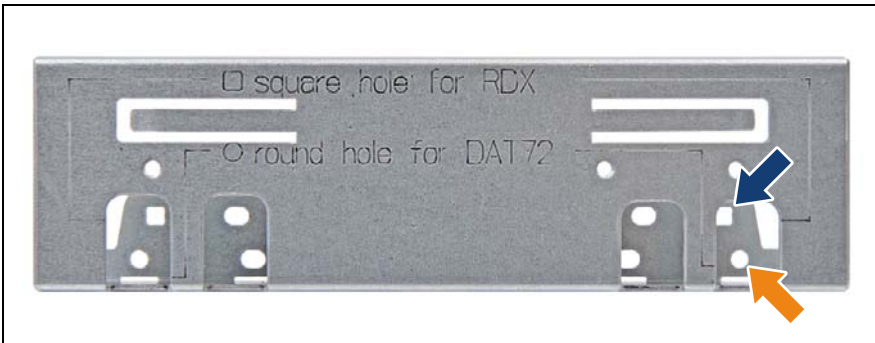

Figure 192: Screw holes on backup drive mounting brackets

- ▶ Note the screw hole description stamped onto the mounting bracket:
 - ▶ Use the square screw hole for RDX backup drives (see blue arrow).
 - ▶ Use the round screw holes for DAT72 backup drives (see orange arrow).



Figure 193: Securing mounting brackets to an RDX backup drive

- ▶ Secure the backup drive mounting brackets to the RDX backup drive with two screws per bracket as shown.



Figure 194: Securing mounting brackets to a DAT72 backup drive

- ▶ Secure the backup drive mounting brackets to the DAT72 backup drive with two screws per bracket as shown.

12.2.4 Installing an accessible drive

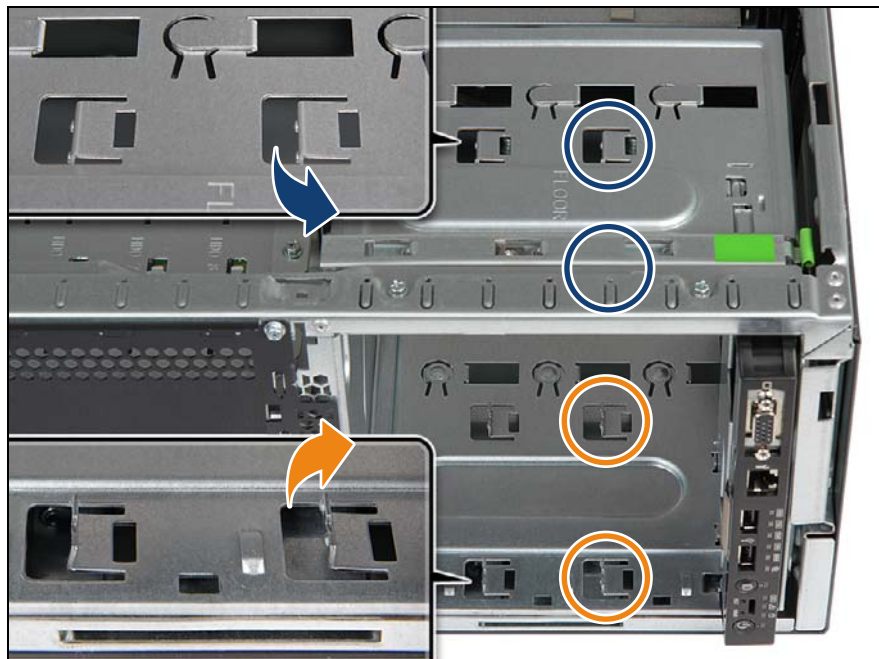

Figure 195: Checking mounting bracket positions (Example: ODD installation, bay 1)

- ▶ Ensure that the four mounting brackets in the desired accessible drive bay have not been bent out. If necessary, proceed as follows:
 - ▶ Using a screw driver, bend the mounting brackets of the upper installation bay inwards, so that their sides are flush with the bay walls (see close-up).
 - ▶ Bend down the upper two mounting brackets (see blue circles).
 - ▶ Bend up the lower two mounting brackets (see orange circles).

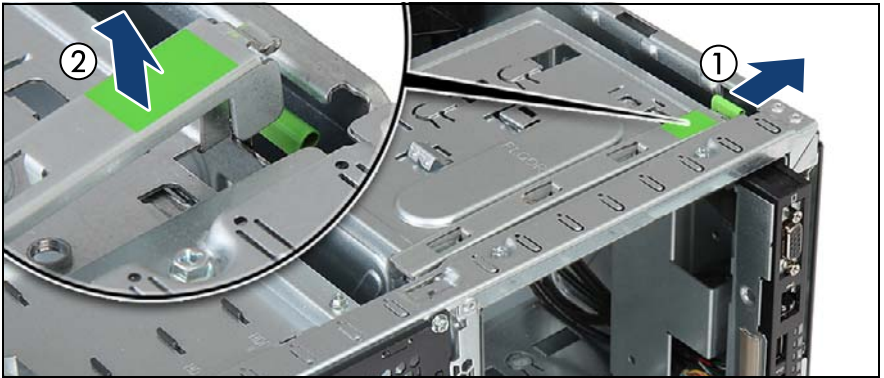

Figure 196: Opening the accessible drive locking bar

- ▶ Press out on the locking latch to disengage the accessible drive locking bar (1).
- ▶ Fold up the accessible drive locking bar (2).

i Unlocking and securing the front panel and accessible drives is illustrated by the example of tower servers. In case of rack servers, the accessible drive locking bar is located on the side of the drive bay. In this case, proceed as follows:

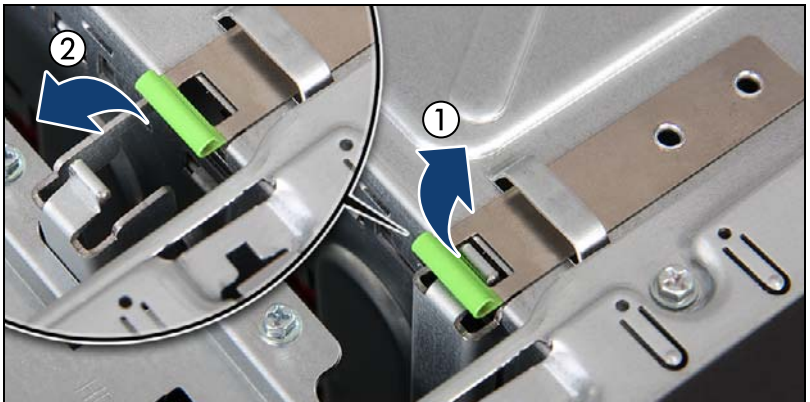

Figure 197: Opening the accessible drive locking bar (rack systems)

- ▶ Pull up on the locking latch to disengage the accessible drive locking bar (1).
- ▶ Fold out the accessible drive locking bar (2).



Figure 198: Inserting the accessible drive

- ▶ Insert the accessible drive into its installation bay and carefully push in until the front screw hole on the front panel frame lines up with the centering pin on the locking bar (1).



CAUTION!

For installing a LTO drive: ensure that the power cables routed behind the accessible drive cage are not trapped when pushing the LTO drive in its bay.

- ▶ Close the locking bar (2) until it locks in place (3).
- ▶ Connect the SATA and power cables according to your configuration see section "[Cabling plans](#)" on page 403.

12.2.5 Concluding steps

- ▶ ["Installing the system fan holder" on page 77](#)
- ▶ ["Reassembling" on page 64](#)
- ▶ ["Connecting the server to the mains" on page 74](#)
- ▶ ["Switching on the server" on page 75](#)
- ▶ If applicable, ["Verifying and configuring the backup software solution" on page 91](#)

12.3 Removing accessible drives



Upgrade and Repair Unit (URU)



Hardware: 10 minutes

Tools: tool-less

12.3.1 Preliminary steps

- ▶ ["Locating the defective server" on page 47](#)
- ▶ ["Removing backup and optical disk media" on page 81](#)
- ▶ ["Verifying and configuring the backup software solution" on page 82](#)
- ▶ ["Shutting down the server" on page 50](#)
- ▶ ["Disconnecting the server from the mains" on page 50](#)
- ▶ ["Getting access to the component" on page 51](#)



The front cover only needs to be removed in order to remove or install accessible drive dummy covers.

- ▶ ["Removing the system fan holder" on page 76](#)

12.3.2 Removing an accessible drive

- ▶ Remove all cables from the accessible drive see section "[Cabling plans](#)" on page 403.
- ▶ Press out on the locking latch to disengage the accessible drive locking bar (see figure 196).
- ▶ Fold up the accessible drive locking bar.

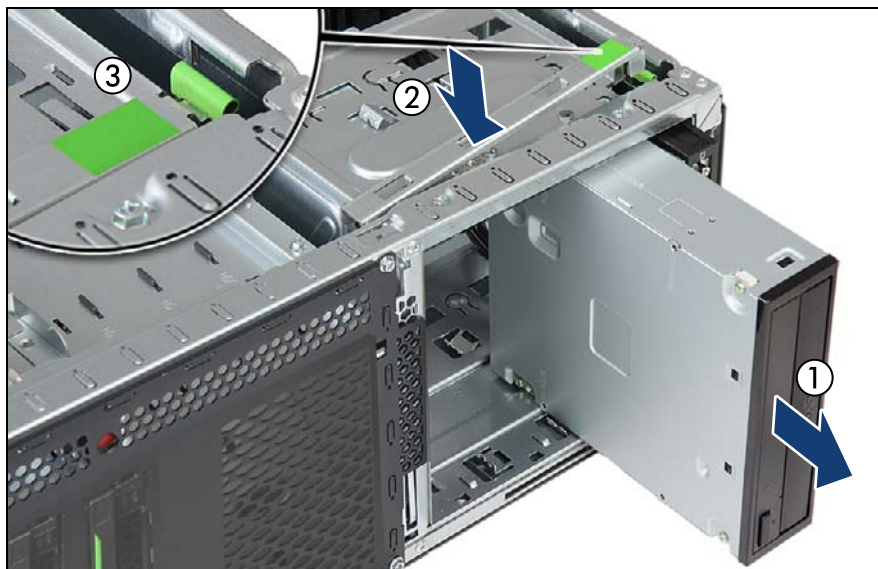

Figure 199: Removing the accessible drive

- ▶ Carefully pull the accessible drive out of its installation bay (1).
- ▶ Close the locking bar (2) until it locks in place (3).

12.3.3 Installing accessible drive dummy covers

- ▶ If applicable, install the accessible dummy covers for the desired accessible drive bay as described in section "[Installing accessible drive dummy covers](#)" on page 179.

12.3.4 Concluding steps

- ▶ "Installing the system fan holder" on page 77
- ▶ "Reassembling" on page 64
- ▶ "Connecting the server to the mains" on page 74
- ▶ "Switching on the server" on page 75
- ▶ If applicable, "Verifying and configuring the backup software solution" on page 91

12.4 Replacing accessible drives



**Upgrade and Repair Unit
(URU)**



Hardware: 15 minutes

Tools: Slotted screw driver (for bending in or out accessible drive mounting brackets)

12.4.1 Preliminary steps

- ▶ "Locating the defective server" on page 47
- ▶ "Removing backup and optical disk media" on page 81
- ▶ "Verifying and configuring the backup software solution" on page 82
- ▶ "Shutting down the server" on page 50
- ▶ "Disconnecting the server from the mains" on page 50
- ▶ "Getting access to the component" on page 51



Removing the front cover is not required in order to replace an accessible drive.

- ▶ "Removing the system fan holder" on page 76

12.4.2 Removing the defective accessible drive

- ▶ Remove all cables from the accessible drive.
- ▶ Remove the accessible drive as described in section ["Removing an accessible drive" on page 284](#).

12.4.3 Installing the new accessible drive

- ▶ Install the accessible drive as described in section ["Installing an accessible drive" on page 280](#).
- ▶ Reconnect all cables to their original accessible drive connectors as described in section ["Cabling plans" on page 403](#).

12.4.4 Concluding steps

- ▶ ["Installing the system fan holder" on page 77](#)
- ▶ ["Reassembling" on page 64](#)
- ▶ ["Connecting the server to the mains" on page 74](#)
- ▶ ["Switching on the server" on page 75](#)
- ▶ ["Verifying and configuring the backup software solution" on page 91](#) (if applicable)

12.5 Slimline ODD and LSD in Multibay box

12.5.1 Installing the slimline ODD or LSD



Upgrade and Repair Unit (URU)



Hardware: 10 minutes

Tools:

- Phillips PH2 / (+) No. 2 screw driver
- Slotted screw driver (for bending in or out accessible drive mounting brackets)

12.5.1.1 Preliminary steps

- ▶ ["Shutting down the server" on page 50](#)
- ▶ ["Disconnecting the server from the mains" on page 50](#)
- ▶ ["Getting access to the component" on page 51](#)



The front cover only needs to be removed in order to remove or install accessible drive dummy covers. If the Multibay box is already installed in the server and will be removed in order to install a slimline ODD or LSD module, the front cover can remain installed.

- ▶ ["Removing the system fan holder" on page 76](#)
- ▶ ["Removing the Multibay box" on page 294](#) (if applicable)

12.5.1.2 Installing the slimline ODD

- ▶ Press up on the locking tab to disengage the slimline ODD dummy module as shown in [figure 210 on page 295](#).
- ▶ From inside the Multibay module, press out on the ODD dummy module and pull it out of its bay.

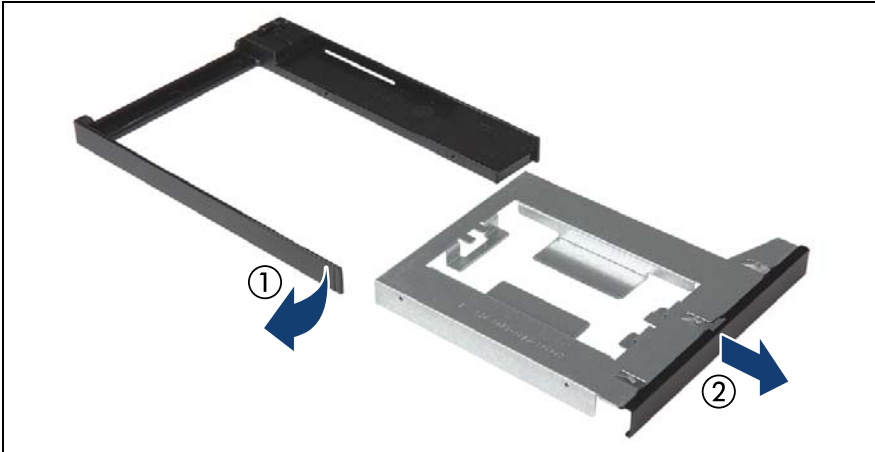

Figure 200: Disassembling the slimline ODD dummy module

- ▶ Disengage (1) and remove (2) the slimline ODD dummy from the slimline ODD installation frame.

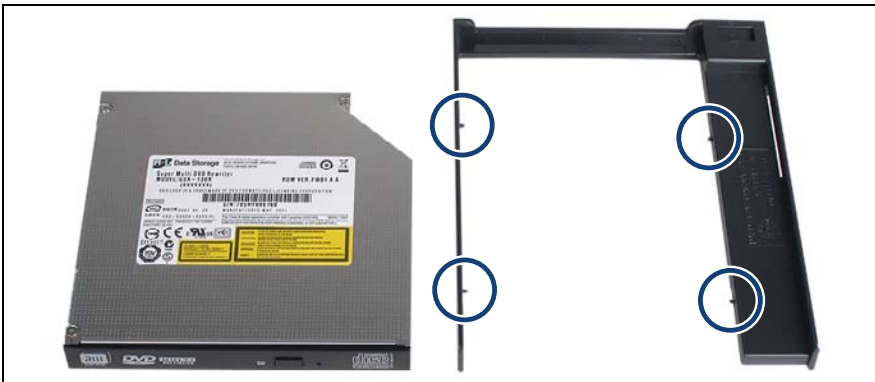

Figure 201: Mounting the slimline ODD in the installation frame

- ▶ Fit the slimline ODD into the slimline ODD installation frame.
- ▶ Ensure that the four pins on the frame (see circles) engage with the screw holes on the drive.
- ▶ Ensure that the ODD is properly seated in the installation frame as shown above.



Figure 202: Mounting the slimline ODD module in the Multibay box

- ▶ Insert the slimline ODD module into the Multibay box (1) and push back until the locking tab (2) engages.



Figure 203: Mounting the slimline ODD in the installation frame (B)

- ▶ Connect the SATA power cable (1) and the SATA cable (2) to the slimline ODD.

12.5.1.3 Installing the LSD module

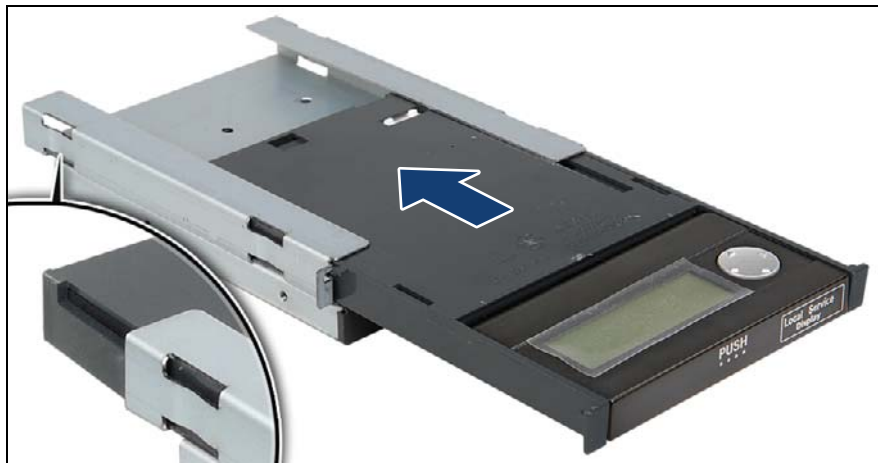

Figure 204: Inserting the LSD module into the 3.5-inch installation frame

- ▶ From the front, slide the LSD module into the 3.5-inch installation frame until the locking latch (see close-up) engages.

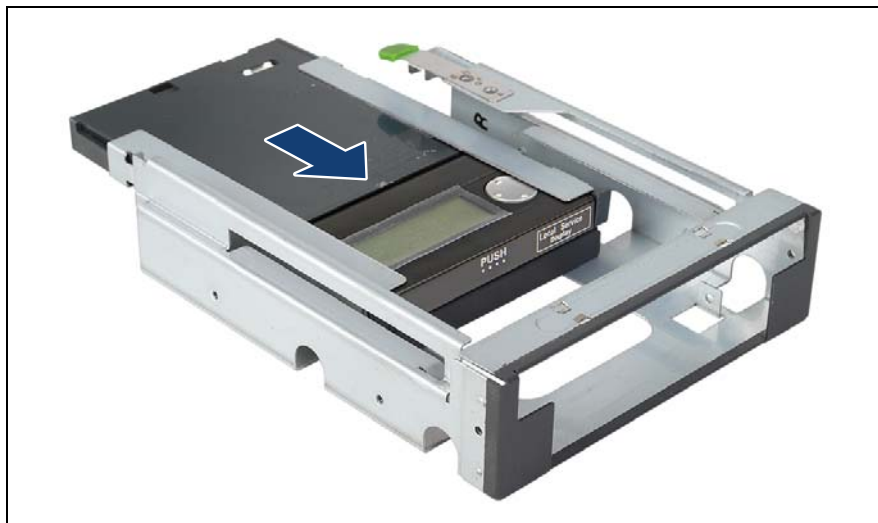

Figure 205: Installing the 3.5-inch installation frame in the Multibay box (A)

- ▶ From the rear, slide the 3.5-inch installation frame into the Multibay box.

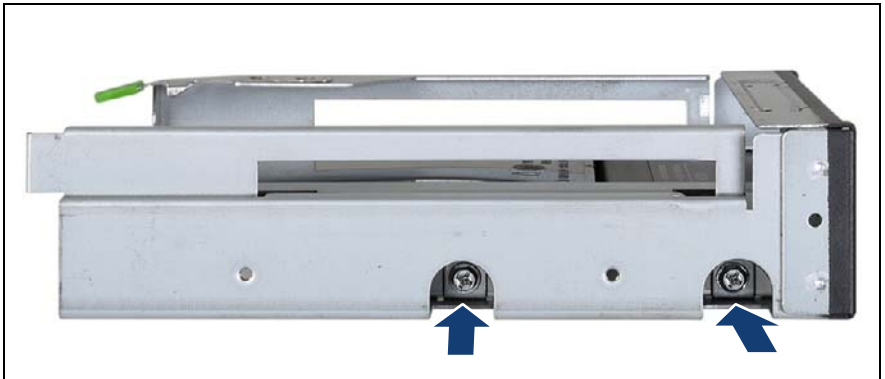

Figure 206: Installing the 3.5-inch installation frame in the Multibay box (B)

- ▶ Secure the installation frame in the Multibay box with two screws (M3 x 6 mm) on either side.
- ▶ Before inserting the Multibay box into the chassis, connect the LSD cable to the LSD module.

12.5.1.4 Removing accessible drive dummy covers

- ▶ If applicable, remove the accessible dummy covers for installation bay 1 as described in section ["Removing accessible drive dummy covers"](#) on [page 171](#).

12.5.1.5 Installing the Multibay box

- ▶ Ensure that the four mounting brackets in installation bay 1 have not been bent out (see [figure 195](#)).
- ▶ Press out on the locking latch to disengage the accessible drive locking bar (see [figure 196](#)).
- ▶ Fold up the accessible drive locking bar.



Figure 207: Inserting the Multibay box

- ▶ Insert the Multibay box into installation bay 1 and carefully push in until the front screw hole on the front panel frame lines up with the centering pin on the locking bar (1).
- ▶ Close the locking bar (2) until it locks in place (3).

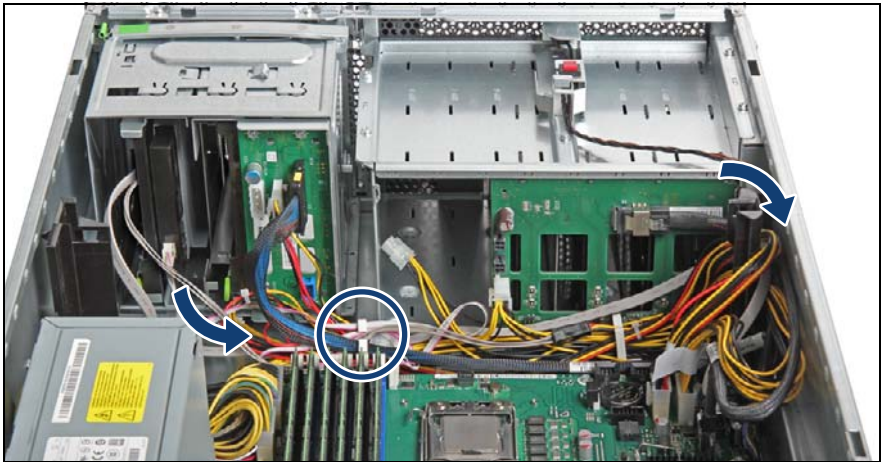

Figure 208: Routing cables

- ▶ Connect the LSD, SATA and power cables (see section ["Cabling" on page 401](#)).
- ▶ Run the SATA cable along the drive bays and through the cable clamp on the server floor as shown.
- ▶ Run the SATA cable through the cable guide.

12.5.1.6 Concluding steps

- ▶ ["Installing the system fan holder" on page 77](#)
- ▶ ["Reassembling" on page 64](#)
- ▶ ["Connecting the server to the mains" on page 74](#)
- ▶ ["Switching on the server" on page 75](#)

12.5.2 Removing a slimline ODD or LSD



Upgrade and Repair Unit (URU)



Hardware: 10 minutes

Tools: Phillips PH2 / (+) No. 2 screw driver

12.5.2.1 Preliminary steps

- ▶ ["Removing backup and optical disk media" on page 81](#)
- ▶ ["Shutting down the server" on page 50](#)
- ▶ ["Disconnecting the server from the mains" on page 50](#)
- ▶ ["Getting access to the component" on page 51](#)



The front cover only needs to be removed in order to remove or install accessible drive dummy covers. If the Multibay will be reinstalled after removing the slimline ODD or LSD module, the front cover can remain installed.

- ▶ ["Removing the system fan holder" on page 76](#)

12.5.2.2 Removing the Multibay box

- ▶ Remove all cables from the slimline ODD.
- ▶ Remove the LSD cable from system board connector SMB 1.
- ▶ Press out on the locking latch to disengage the accessible drive locking bar (see figure 196).
- ▶ Fold up the accessible drive locking bar.

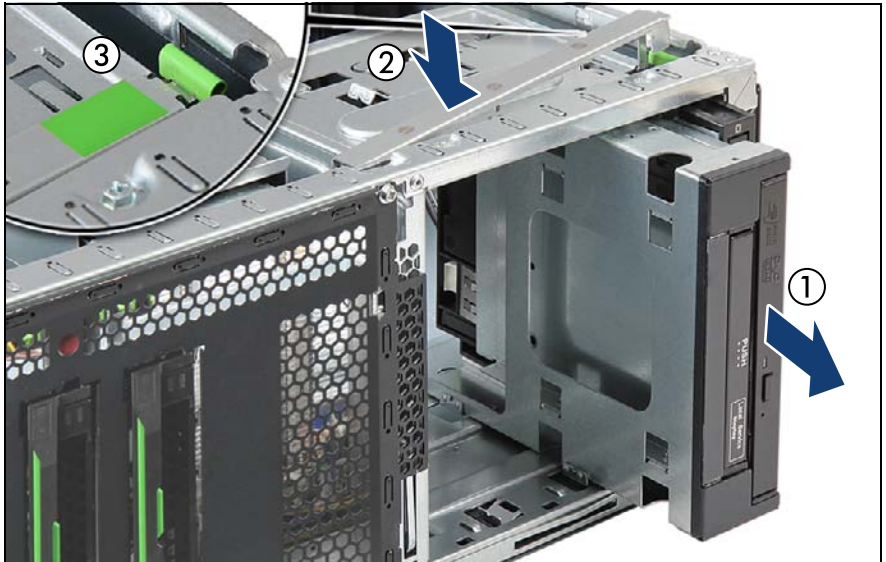

Figure 209: Removing the Multibay box

- ▶ Carefully pull the Multibay box out of its installation bay (1).
- ▶ Close the locking bar (2) until it locks in place (3).

12.5.2.3 Removing the slimline ODD

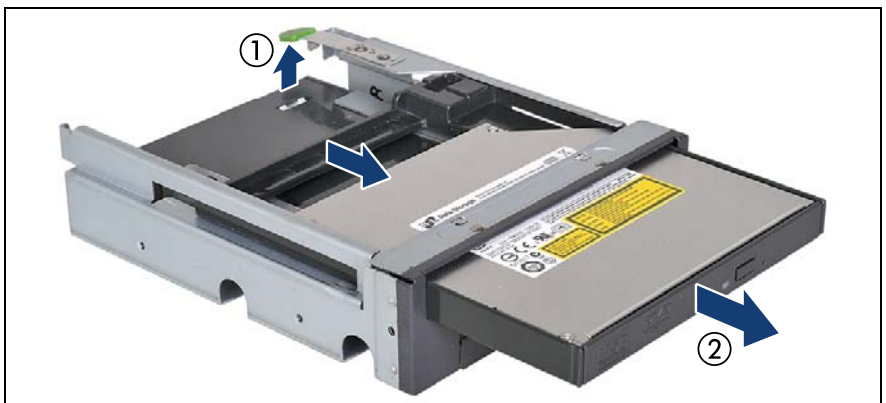

Figure 210: Removing the slimline ODD from the Multibay box

- ▶ Press up on the locking tab to disengage the slimline ODD module (1).

Accessible drives and LSD

- ▶ From inside the Multibay box, press out on the slimline ODD module and pull it out of its bay (2).



Figure 211: Removing the slimline ODD from its installation frame

- ▶ Disengage (1) and remove (2) the slimline ODD from its installation frame.

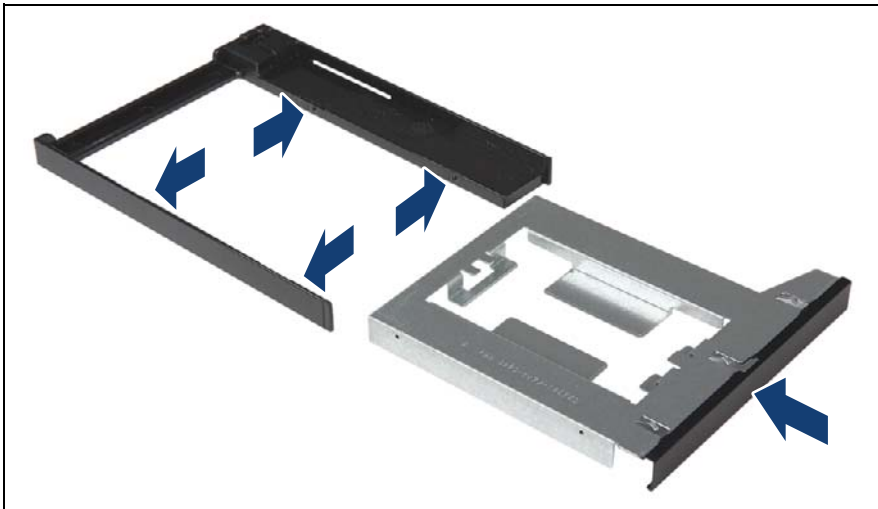

Figure 212: Mounting the slimline ODD dummy insert in the installation frame

- ▶ Fit the slimline ODD dummy insert into the slimline ODD installation frame.

- ▶ Ensure that the four pins on the frame (see arrows) engage with the side holes on the dummy insert.
- ▶ Insert the slimline ODD dummy module into the Multibay box and push back until the locking tab engages as shown in [figure 202 on page 289](#).

12.5.2.4 Removing the LSD module

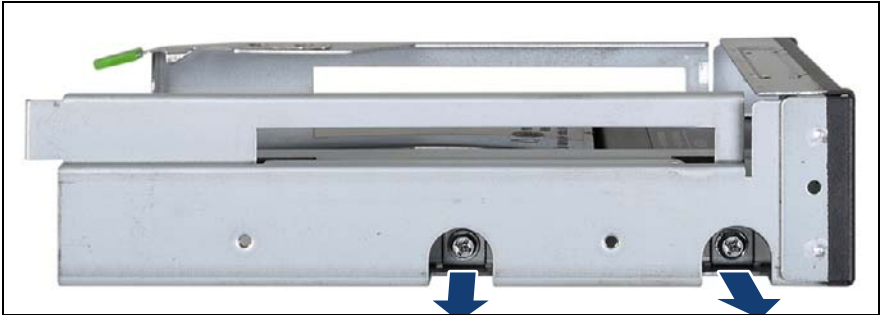

Figure 213: Removing the 3.5-inch installation frame from the Multibay box (A)

- ▶ Remove two screws on either side of the Multibay box to disengage the 3.5-inch installation bay.

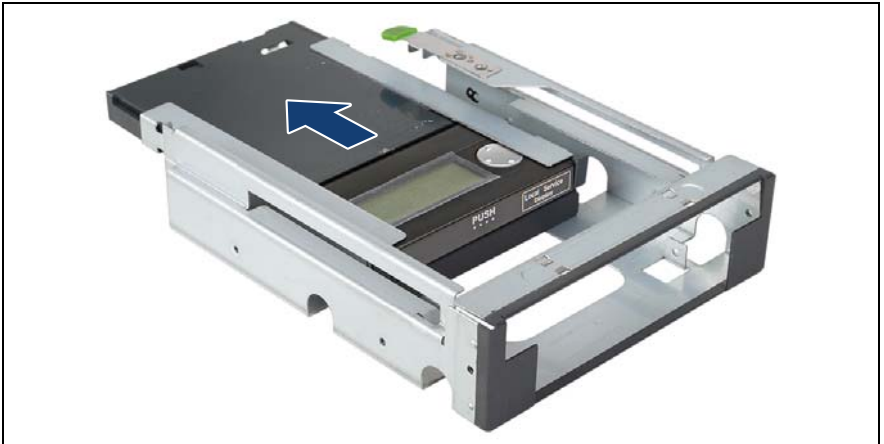

Figure 214: Removing the 3.5-inch installation frame from the Multibay box (B)

- ▶ Slide the 3.5-inch installation frame out of the Multibay box as shown.

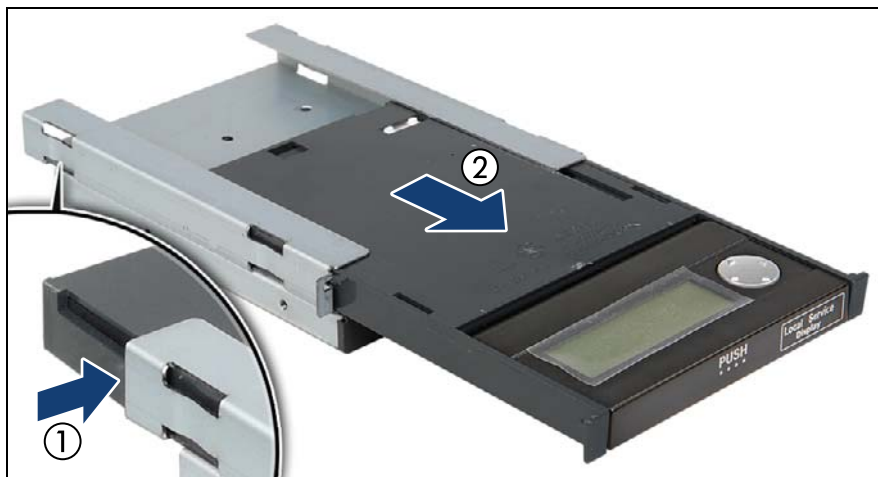

Figure 215: Removing the LSD module from the 3.5-inch installation frame

- ▶ Press in on the locking latch (see close-up) to disengage the LSD module (1).
- ▶ Pull the LSD module out of the 3.5-inch installation frame (2).
- ▶ If the removed LSD module is not to be replaced by a new module, reinstall the LSD dummy cover.

12.5.2.5 Installing the Multibay box

- ▶ Install the Multibay box as described in section ["Installing the Multibay box" on page 291](#).

12.5.2.6 Concluding steps

- ▶ ["Installing the system fan holder" on page 77](#)
- ▶ ["Reassembling" on page 64](#)
- ▶ ["Connecting the server to the mains" on page 74](#)
- ▶ ["Switching on the server" on page 75](#)

12.5.3 Replacing a slimline ODD or LSD



Upgrade and Repair Unit (URU)



Hardware: 10 minutes

Tools: – Phillips PH2 / (+) No. 2 screw driver
 – Slotted screw driver (for bending in or out accessible drive mounting brackets)

12.5.3.1 Preliminary steps

- ▶ ["Locating the defective server" on page 47](#)
- ▶ ["Removing backup and optical disk media" on page 81](#)
- ▶ ["Shutting down the server" on page 50](#)
- ▶ ["Disconnecting the server from the mains" on page 50](#)
- ▶ ["Getting access to the component" on page 51](#)



Removing the front cover is not required in order to replace the slimline ODD or LSD module in the Multibay box.

- ▶ ["Removing the system fan holder" on page 76](#)
- ▶ ["Removing the Multibay box" on page 294](#)

12.5.3.2 Removing the defective slimline ODD

- ▶ Remove the slimline ODD from the Multibay box as described in section ["Removing the slimline ODD" on page 295](#).

12.5.3.3 Removing the defective LSD module

- ▶ Remove the LSD module from the Multibay box as described in section ["Removing the LSD module" on page 297](#).

12.5.3.4 Installing the new slimline ODD

- ▶ Install the slimline ODD into the Multibay box as described in section ["Installing the slimline ODD" on page 287](#).

12.5.3.5 Installing the new LSD module

- ▶ Install the LSD module into the Multibay box as described in section ["Installing the LSD module" on page 290](#).

12.5.3.6 Concluding steps

- ▶ ["Installing the Multibay box" on page 291](#)
- ▶ ["Installing the system fan holder" on page 77](#)
- ▶ ["Reassembling" on page 64](#)
- ▶ ["Connecting the server to the mains" on page 74](#)
- ▶ ["Switching on the server" on page 75](#)
- ▶ If applicable, ["Verifying and configuring the backup software solution" on page 91](#)

12.6 Slimline ODD and LSD in 2x 3.5-inch HDD extension box

12.6.1 Installing the slimline ODD or LSD



Upgrade and Repair Unit (URU)



Hardware: 10 minutes

Tools: Slotted screw driver (for bending in or out accessible drive mounting brackets)

12.6.1.1 Preliminary steps

- ▶ ["Shutting down the server" on page 50](#)
- ▶ ["Disconnecting the server from the mains" on page 50](#)
- ▶ ["Getting access to the component" on page 51](#)

i The front cover only needs to be removed in order to remove or install accessible drive dummy covers. If the HDD extension box is already installed in the server and will be removed in order to install a slimline ODD or LSD module, the front cover can remain installed.

- ▶ "Removing the system fan holder" on page 76
- ▶ "Removing the HDD extension box" on page 177 (if applicable)

12.6.1.2 Installing the slimline ODD

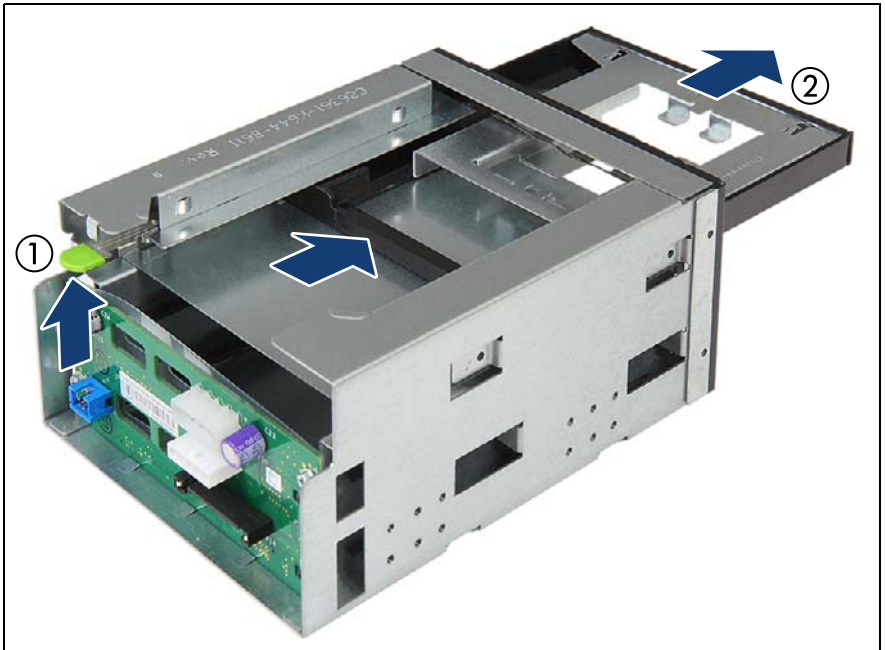

Figure 216: Removing the slimline ODD dummy module

- ▶ Press up on the locking tab to disengage the slimline ODD dummy module (1).
- ▶ From inside the HDD extension box, press out on the ODD dummy module and pull it out of its bay (2).

Accessible drives and LSD

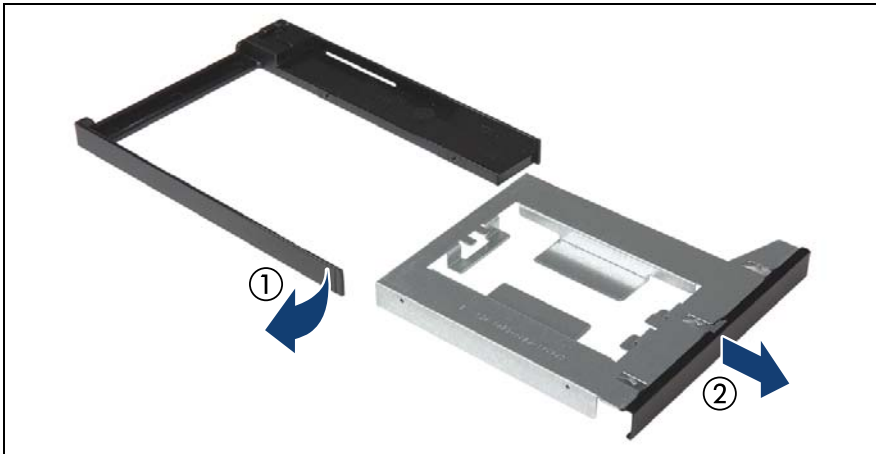

Figure 217: Disassembling the slimline ODD dummy module

- ▶ Disengage (1) and remove (2) the slimline ODD dummy from the slimline ODD installation frame.

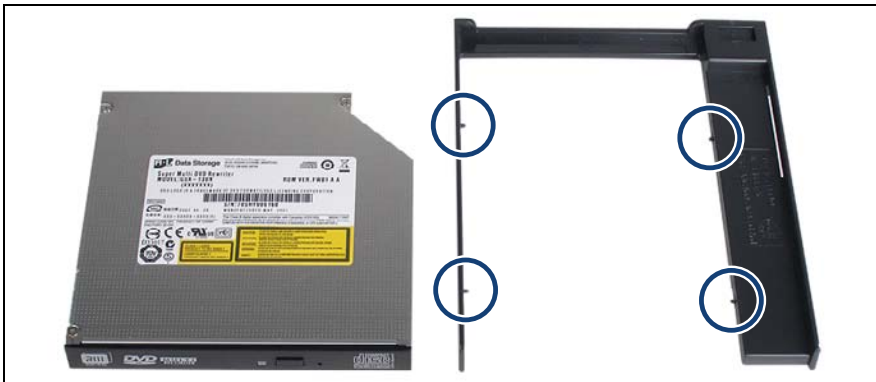

Figure 218: Mounting the slimline ODD in the installation frame

- ▶ Fit the slimline ODD into the slimline ODD installation frame.
- ▶ Ensure that the four pins on the frame (see circles) engage with the screw holes on the drive.
- ▶ Ensure that the ODD is properly seated in the installation frame.

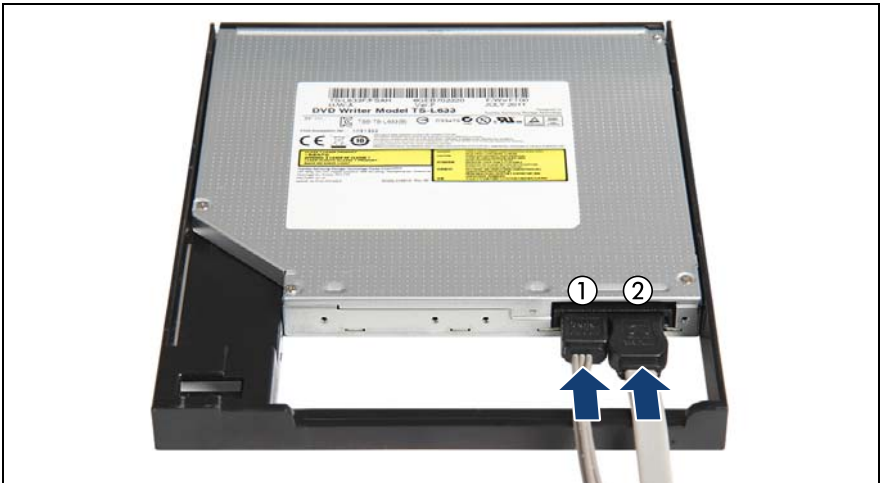

Figure 219: Connecting cables

- ▶ Connect the power cable (1) and the SATA cable (2) to the slimline ODD.

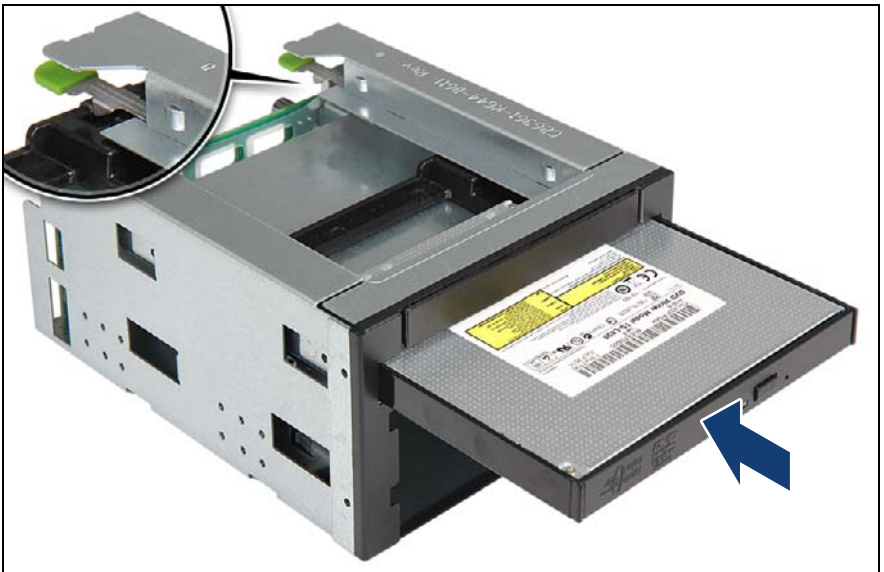

Figure 220: Mounting the slimline ODD module in the HDD expansion box

- ▶ Insert the slimline ODD module into the HDD extension box and push back until the locking tab (see close-up) engages.

12.6.1.3 Installing the LSD



Figure 221: Removing the LSD dummy cover plate (A)

- ▶ Carefully bend out the LSD dummy cover plate (1) and disengage its right edge (2).



Figure 222: Removing the LSD dummy cover plate (B)

- ▶ Fold out (1) and remove (2) the LSD cover plate.

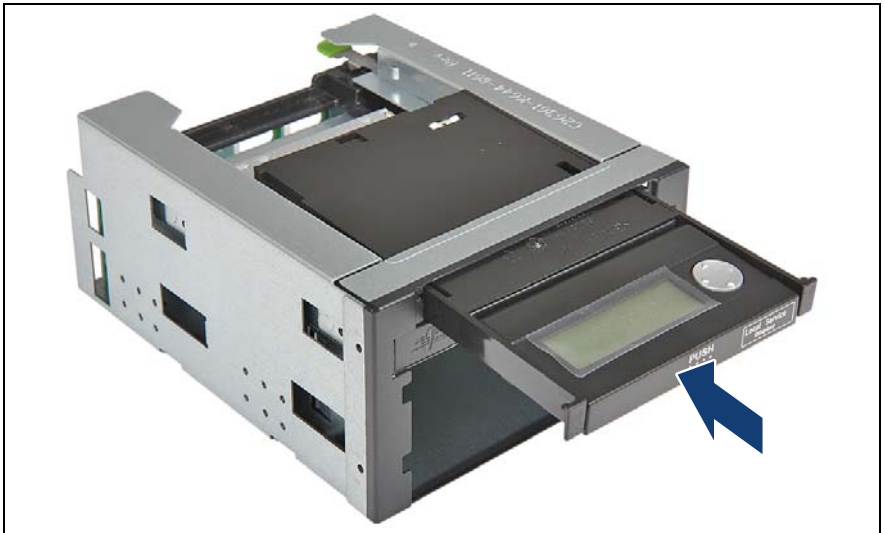

Figure 223: Inserting the LSD module

- ▶ Insert the LSD module into its installation bay and push in until it locks in place.
- ▶ Before inserting the 2x 3.5-inch HDD extension box into the chassis, connect the LSD cable to the LSD module (see section ["Cabling" on page 401](#)).

12.6.1.4 Installing the 2x 3.5-inch HDD extension box

- ▶ Install the 2x 3.5-inch HDD extension box into installation bays 2 and 3 as described in section ["Installing an HDD extension box" on page 170](#).

12.6.1.5 Cabling the slimline ODD and LSD

- ▶ Connect the LSD, SATA and power cables (see section ["Cabling" on page 401](#)).

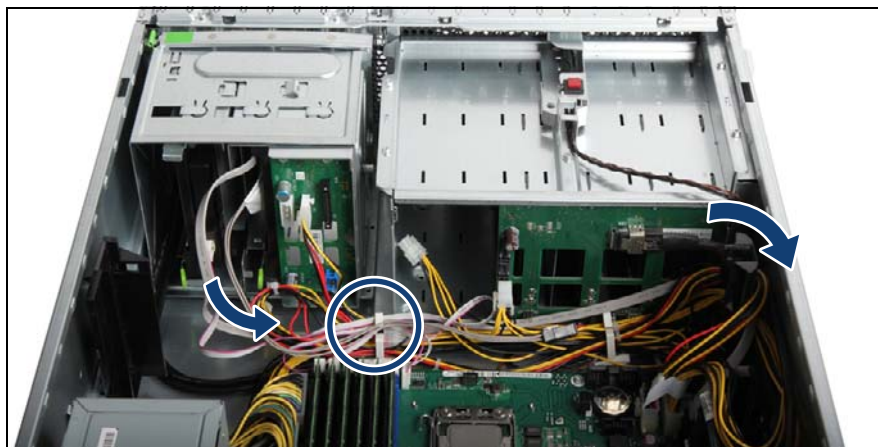

Figure 224: Routing cables

- ▶ Run the SATA cable along the drive bays and through the cable clamp on the server floor as shown.
- ▶ Run the SATA cable through the cable guide.

12.6.1.6 Concluding steps

- ▶ ["Installing the system fan holder" on page 77](#)
- ▶ ["Reassembling" on page 64](#)
- ▶ ["Connecting the server to the mains" on page 74](#)
- ▶ ["Switching on the server" on page 75](#)

12.6.2 Removing the slimline ODD or LSD



**Upgrade and Repair Unit
(URU)**



Hardware: 10 minutes

Tools: tool-less

12.6.2.1 Preliminary steps

- ▶ ["Removing backup and optical disk media" on page 81](#)
- ▶ ["Shutting down the server" on page 50](#)
- ▶ ["Disconnecting the server from the mains" on page 50](#)
- ▶ ["Getting access to the component" on page 51](#)



The front cover only needs to be removed in order to remove or install accessible drive dummy covers. If the HDD extension box will be reinstalled after removing the slimline ODD or LSD module, the front cover can remain installed.

- ▶ ["Removing the system fan holder" on page 76](#)
- ▶ ["Removing the HDD extension box" on page 177](#)

12.6.2.2 Removing the slimline ODD

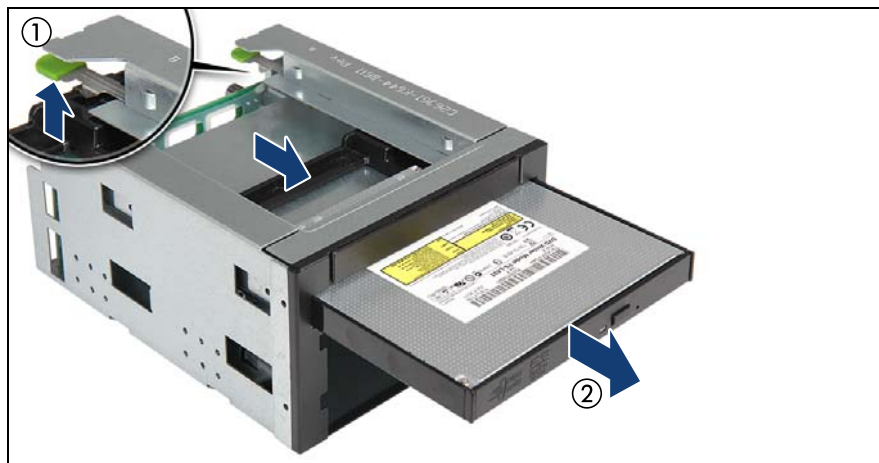

Figure 225: Removing the slimline ODD

- ▶ Press up on the locking tab to disengage the slimline ODD module (1).
- ▶ From inside the HDD extension box, press out on the slimline ODD module and pull it out of its bay (2).



Figure 226: Removing the slimline ODD from its installation frame

- ▶ Disengage (1) and remove (2) the slimline ODD from its installation frame.

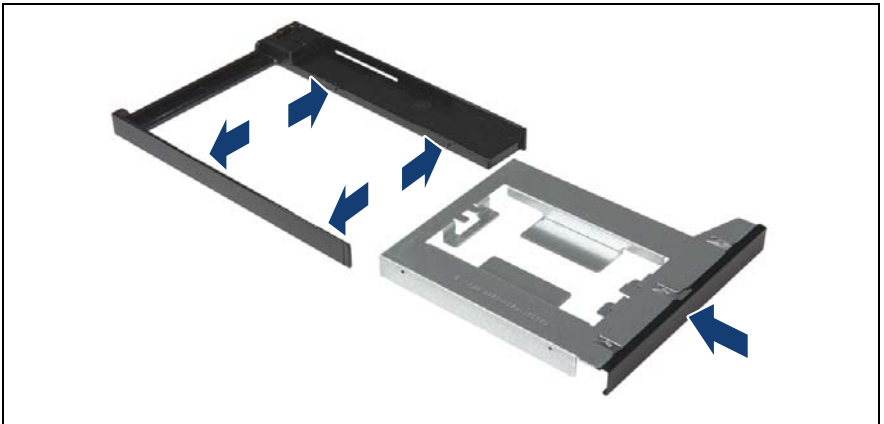

Figure 227: Mounting the slimline ODD dummy insert in the installation frame

- ▶ Fit the slimline ODD dummy insert into the slimline ODD installation frame.
- ▶ Ensure that the four pins on the frame (see arrows) engage with the side holes on the dummy insert.

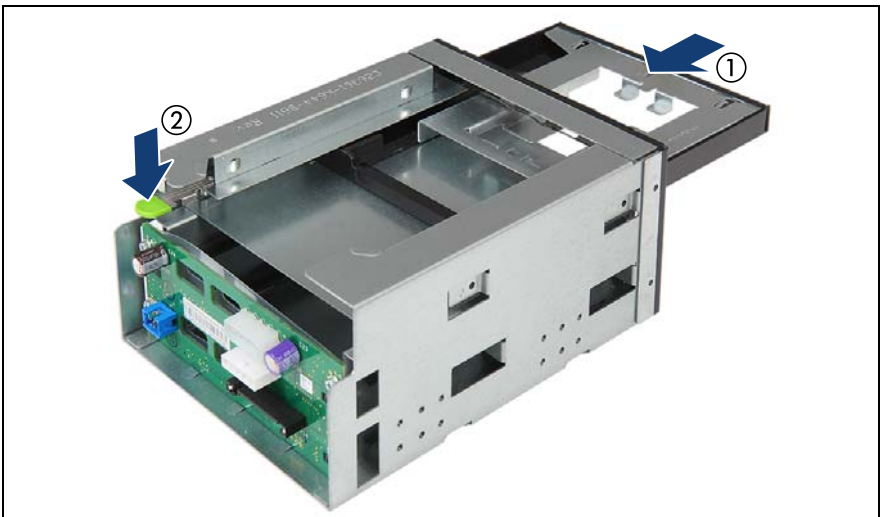

Figure 228: Mounting the slimline ODD module in the HDD expansion box

- ▶ Insert the slimline ODD dummy module into the HDD extension box (1) and push back until the locking tab (2) engages.

12.6.2.3 Removing the LSD

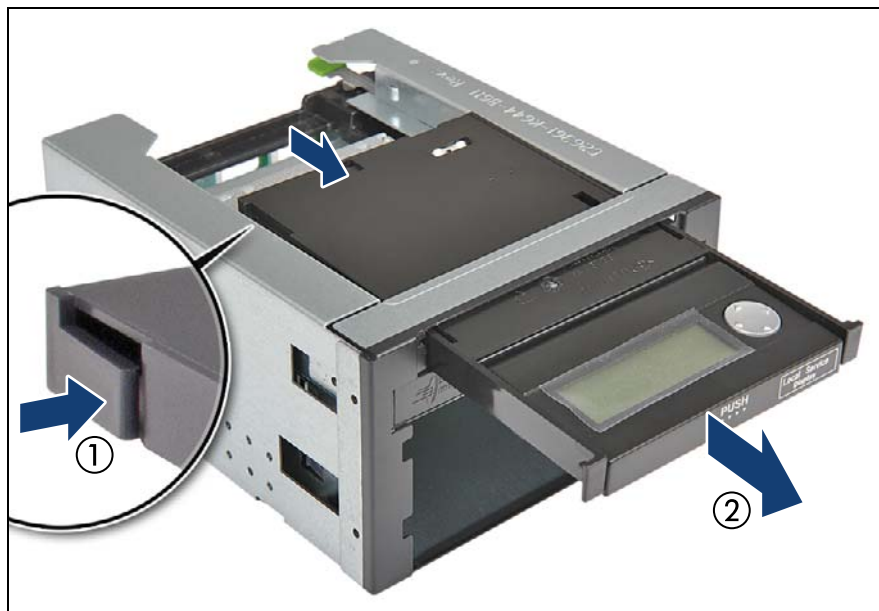

Figure 229: Removing the LSD module

- ▶ From the rear side of the extension box, press in on the locking latch (see close-up) to disengage the LSD module (1).
- ▶ From inside the HDD extension box, press out on the LSD module and pull it out of its bay (2).

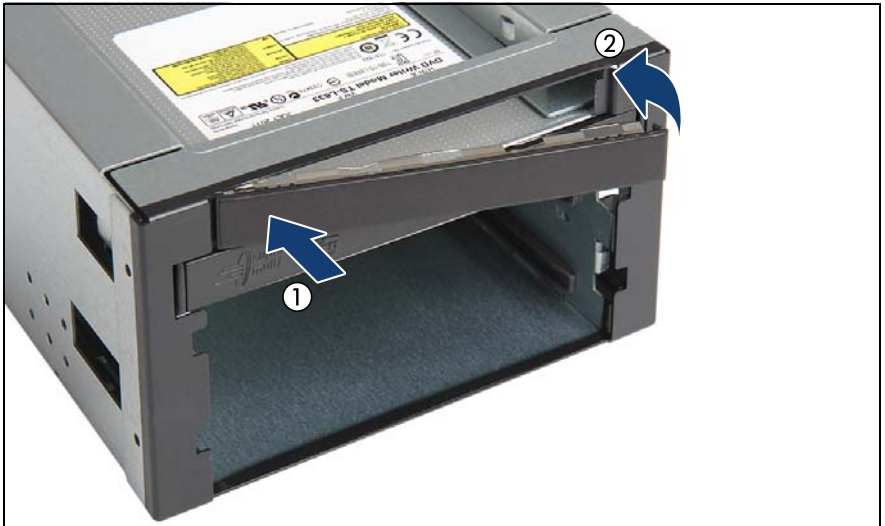

Figure 230: Removing the slimline ODD from its installation frame

- ▶ Fit one edge of the LSD dummy cover plate into the LSD slot (1) as shown.
- ▶ Fold in the dummy cover plate (2).



Figure 231: Mounting the slimline ODD dummy insert in the installation frame

- ▶ Carefully bend out the LSD dummy cover plate (1) and fit its other edge into the LSD slot (2).

12.6.2.4 Concluding steps

- ▶ ["Installing an HDD extension box" on page 170](#)
- ▶ ["Installing the system fan holder" on page 77](#)
- ▶ ["Reassembling" on page 64](#)
- ▶ ["Connecting the server to the mains" on page 74](#)
- ▶ ["Switching on the server" on page 75](#)

12.6.3 Replacing the slimline ODD or LSD



Upgrade and Repair Unit (URU)



Hardware: 10 minutes

Tools: Slotted screw driver (for bending in or out accessible drive mounting brackets)

12.6.3.1 Preliminary steps

- ▶ ["Locating the defective server" on page 47](#)
- ▶ ["Removing backup and optical disk media" on page 81](#)
- ▶ ["Shutting down the server" on page 50](#)
- ▶ ["Disconnecting the server from the mains" on page 50](#)
- ▶ ["Getting access to the component" on page 51](#)



Removing the front cover is not required in order to replace the slimline ODD or LSD module in the 2x 3.5-inch HDD extension box.

- ▶ ["Removing the system fan holder" on page 76](#)
- ▶ ["Removing the HDD extension box" on page 177](#)

12.6.3.2 Removing the defective slimline ODD

- ▶ Remove the slimline ODD from the 2x 3.5-inch HDD extension box as described in section ["Removing the slimline ODD" on page 308](#).

12.6.3.3 Removing the defective LSD module

- ▶ Remove the LSD module from the 2x 3.5-inch HDD extension box as described in section ["Removing the LSD" on page 310](#).

12.6.3.4 Installing the new slimline ODD

- ▶ Install the the slimline ODD into the 2x 3.5-inch HDD extension box as described in section ["Installing the slimline ODD" on page 301](#).

12.6.3.5 Installing the new LSD module

- ▶ Install the LSD module into the 2x 3.5-inch HDD extension box as described in section ["Installing the LSD" on page 304](#).

12.6.3.6 Concluding steps

- ▶ ["Installing the HDD extension box" on page 173](#)
- ▶ ["Installing the system fan holder" on page 77](#)
- ▶ ["Reassembling" on page 64](#)
- ▶ ["Connecting the server to the mains" on page 74](#)
- ▶ ["Switching on the server" on page 75](#)

12.7 Slimline ODD in 4x 3.5-inch HDD extension box

12.7.1 Installing the slimline ODD



Upgrade and Repair Unit (URU)



Hardware: 10 minutes

Tools: – Phillips PH2 / (+) No. 2 screw driver
– Slotted screw driver (for bending in or out accessible drive mounting brackets)

12.7.1.1 Preliminary steps

- ▶ ["Shutting down the server" on page 50](#)
- ▶ ["Disconnecting the server from the mains" on page 50](#)
- ▶ ["Getting access to the component" on page 51](#)



The front cover only needs to be removed in order to remove or install accessible drive dummy covers. If the HDD extension box is already installed in the server and will be removed in order to install a slimline ODD or LSD module, the front cover can remain installed.

- ▶ ["Removing the system fan holder" on page 76](#)
- ▶ ["Removing an HDD extension box" on page 177](#) (if applicable)

12.7.1.2 Installing the slimline ODD



Figure 232: Removing the slimline ODD mounting bracket

- ▶ Remove two screws from the slimline ODD mounting bracket.
- ▶ Remove the slimline ODD mounting bracket.

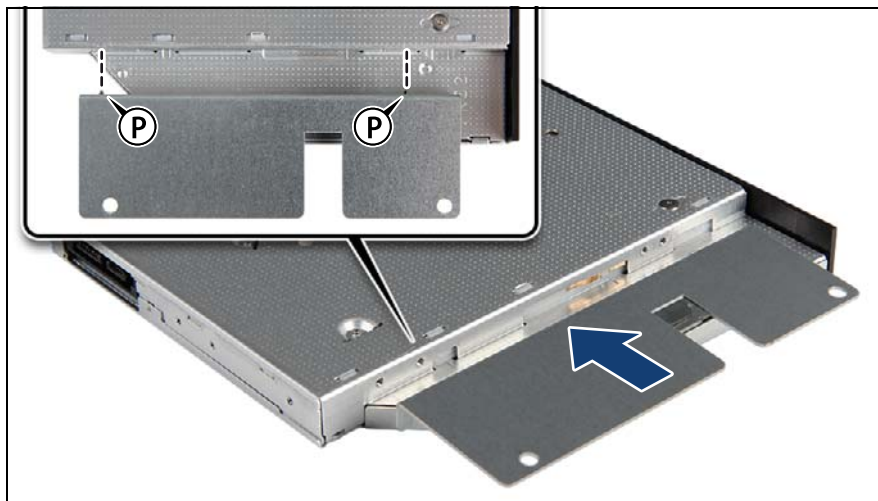

Figure 233: Installing the slimline ODD mounting bracket on the ODD (A)

- ▶ Turn the slimline ODD upside down.
- ▶ Fit the mounting bracket on the slimline ODD as shown.
- ▶ Ensure that the two pins (P) on the mounting bracket properly engage with the screw holes in the drive.



Figure 234: Installing the slimline ODD mounting bracket on the ODD (B)

- ▶ Ensure that the slimline ODD mounting bracket is properly seated on the drive as shown.



Figure 235: Installing the slimline ODD on the HDD extension box

- ▶ Hook the two latches on the left edge of the slimline ODD into the metal guides on the 4x 3.5-inch HDD extension box as shown (see close-up).
- ▶ Fold down the slimline ODD.



Figure 236: Installing the slimline ODD on the HDD extension box (B)

- ▶ Secure the slimline ODD mounting bracket on the 4x 3.5-inch HDD extension box with two screws.



Figure 237: Connecting cables

- ▶ Connect the power cable (1) and the SATA cable (2) to the slimline ODD.

12.7.1.3 Installing the 4x 3.5-inch HDD extension box

- ▶ Install the 4x 3.5-inch HDD extension box into installation bays 1, 2 and 3 as described in section ["Installing an HDD extension box" on page 170](#).

12.7.1.4 Cabling the slimline ODD

- ▶ Connect the SATA and power cables (see section ["Cabling" on page 401](#)).

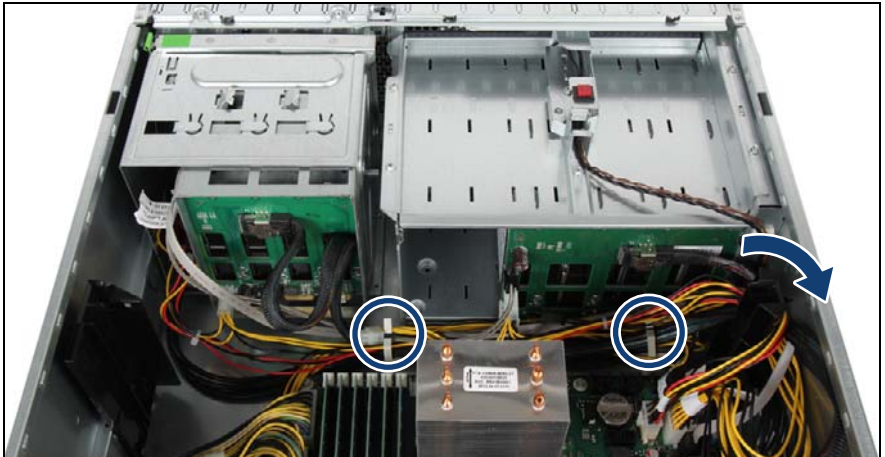

Figure 238: Routing cables

- ▶ Run the SATA cable along the drive bays and through the cable clamps on the server floor as shown.
- ▶ Run the SATA cable through the cable guide.

12.7.1.5 Concluding steps

- ▶ ["Installing the system fan holder" on page 77](#)
- ▶ ["Reassembling" on page 64](#)
- ▶ ["Connecting the server to the mains" on page 74](#)
- ▶ ["Switching on the server" on page 75](#)

12.7.2 Removing the slimline ODD



Upgrade and Repair Unit (URU)



Hardware: 10 minutes

Tools: Phillips PH2 / (+) No. 2 screw driver

12.7.2.1 Preliminary steps

- ▶ ["Removing backup and optical disk media" on page 81](#)
- ▶ ["Shutting down the server" on page 50](#)
- ▶ ["Disconnecting the server from the mains" on page 50](#)
- ▶ ["Getting access to the component" on page 51](#)



The front cover only needs to be removed in order to remove or install accessible drive dummy covers. If the HDD extension box will be reinstalled after removing the slimline ODD, the front cover can remain installed.

- ▶ ["Removing the system fan holder" on page 76](#)
- ▶ ["Removing an HDD extension box" on page 177](#)

12.7.2.2 Removing the slimline ODD



Figure 239: Removing the slimline ODD from the extension box (A)

- ▶ Remove two screws from the slimline ODD mounting bracket.



Figure 240: Removing the slimline ODD from the extension box (B)

- ▶ Fold up (1) and remove (2) the slimline ODD as shown.

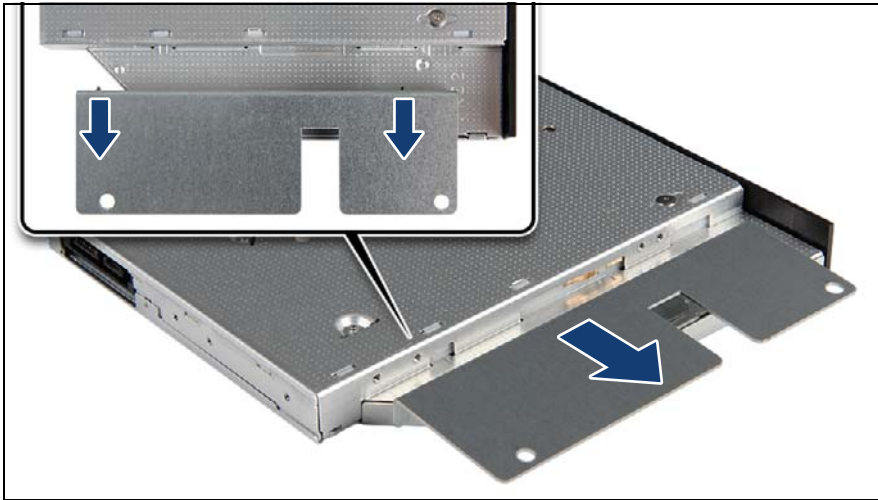

Figure 241: Removing the mounting frame from the slimline ODD

- ▶ Remove the slimline ODD mounting bracket from the slimline ODD.



Figure 242: Reinstalling the slimline ODD mounting frame on the HDD expansion box

- ▶ If the removed slimline ODD is not to be replaced by a new drive, reinstall the slimline ODD mounting bracket on the 4x 3.5-inch HDD extension box.
Secure the slimline ODD mounting bracket on the HDD extension box with two screws.

12.7.2.3 Concluding steps

- ▶ ["Installing an HDD extension box" on page 170](#)
- ▶ ["Installing the system fan holder" on page 77](#)
- ▶ ["Reassembling" on page 64](#)
- ▶ ["Connecting the server to the mains" on page 74](#)
- ▶ ["Switching on the server" on page 75](#)

12.7.3 Replacing the slimline ODD



Upgrade and Repair Unit (URU)



Hardware: 10 minutes

Tools: <ul style="list-style-type: none">– Phillips PH2 / (+) No. 2 screw driver– Slotted screw driver (for bending in or out accessible drive mounting brackets)

12.7.3.1 Preliminary steps

- ▶ ["Locating the defective server" on page 47](#)
- ▶ ["Removing backup and optical disk media" on page 81](#)
- ▶ ["Shutting down the server" on page 50](#)
- ▶ ["Disconnecting the server from the mains" on page 50](#)
- ▶ ["Getting access to the component" on page 51](#)



Removing the front cover is not required in order to replace the slimline ODD or LSD module in the 2x 3.5-inch HDD extension box.

- ▶ ["Removing the system fan holder" on page 76](#)
- ▶ ["Removing an HDD extension box" on page 177](#)

12.7.3.2 Removing the defective slimline ODD

- ▶ Remove the slimline ODD from the 4x 3.5-inch HDD extension box as described in section ["Removing the slimline ODD" on page 321](#).

12.7.3.3 Installing the new slimline ODD

- ▶ Install the slimline ODD onto the 4x 3.5-inch HDD extension box as described in section ["Installing the new slimline ODD" on page 324](#).

12.7.3.4 Concluding steps

- ▶ ["Installing an HDD extension box" on page 170](#)
- ▶ ["Installing the system fan holder" on page 77](#)
- ▶ ["Reassembling" on page 64](#)
- ▶ ["Switching on the server" on page 75](#)

13 Front panel and external connectors

Safety notes



CAUTION!

- When inserting the front panel module into the server, ensure not to pinch or strain any connected cables.
- Circuit boards and soldered parts of internal options are exposed and can be damaged by static electricity. Always discharge static build-up (e.g. by touching a grounded object) before handling electrostatic-sensitive devices (ESDs)
- Do not touch the circuitry on boards or soldered parts. Hold circuit boards by their metallic areas or edges.
- For further information, please refer to chapter "[Important information](#)" on page 35.

13.1 Front panel module

13.1.1 Replacing the front panel module



Field Replaceable Unit (FRU)



Hardware: 10 minutes
Software: 5 minutes

Tools: tool-less

Note on system information backup / restore



The front panel module contains the Chassis ID EPROM that contains system information like server name and model, housing type, serial number and manufacturing data.

To avoid the loss of non-default settings when replacing the system board, a backup copy of important system configuration data is automatically stored from the system board NVRAM to the Chassis ID EPROM. After replacing the system board the backup data is restored from the Chassis ID board to the new system board.



CAUTION!

For that reason the front panel module and system board must not be replaced simultaneously! In this case, restoring the system configuration data on the system board would fail.

13.1.1.1 Preliminary steps

- ▶ ["Disabling BitLocker functionality" on page 79](#)
- ▶ ["Disabling SVOM boot watchdog functionality" on page 80](#)
- ▶ ["Locating the defective server" on page 47](#)
- ▶ ["Shutting down the server" on page 50](#)
- ▶ ["Disconnecting the server from the mains" on page 50](#)
- ▶ ["Getting access to the component" on page 51](#)
- ▶ ["Removing the system fan holder" on page 76](#)

13.1.1.2 Removing the front panel module

Disconnecting cables

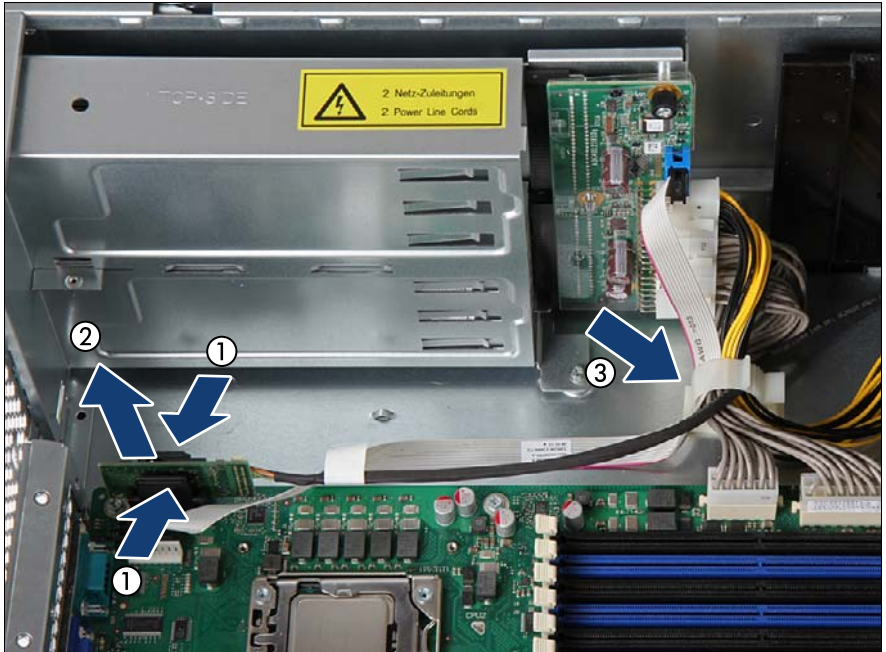

Figure 243: Disconnecting the front LAN board

- ▶ If applicable, disconnect the front LAN board from the system board:
 - ▶ Press in on the locking latch on the front LAN board holder (1).
 - ▶ While holding the locking latch pressed, pull the front LAN board out of its socket (2).
- ▶ Remove the front LAN cable from the cable guide (3).

Front panel and external connectors

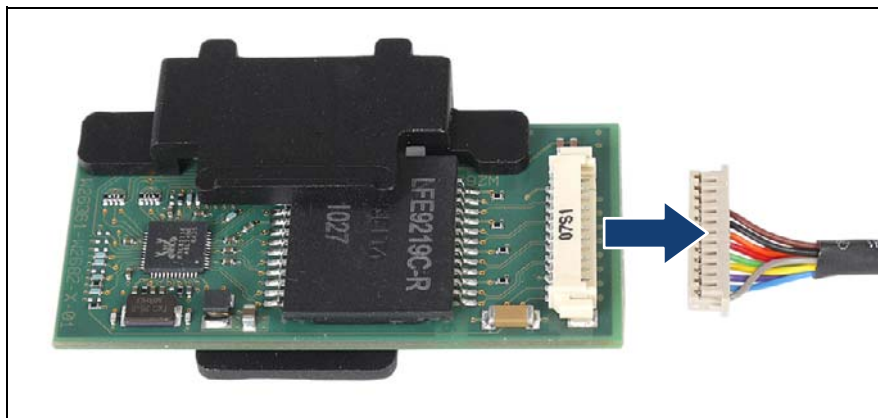

Figure 244: Disconnecting the front LAN cable

- ▶ Disconnect the front LAN cable from the front LAN board.
- ▶ Remove the front LAN board from the chassis and set aside.

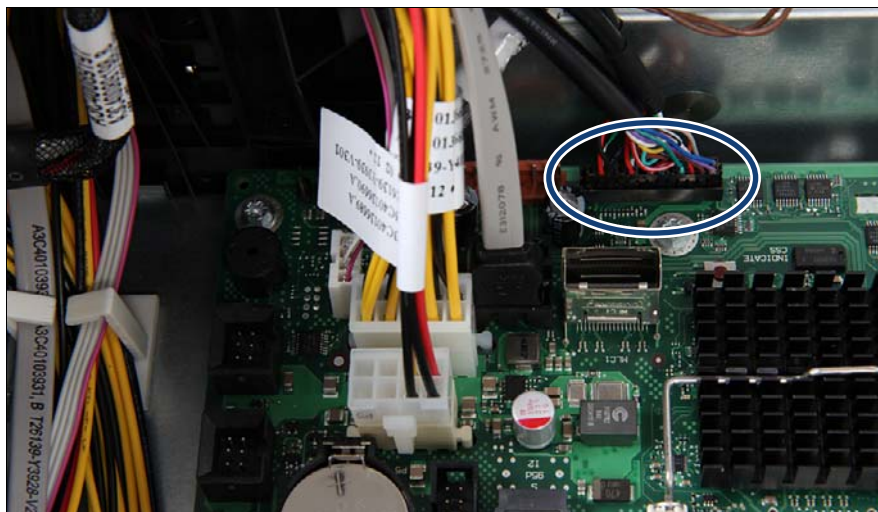

Figure 245: Disconnecting front panel cables

- ▶ Disconnect the front panel cable from the system board (see circle).
- ▶ Remove all front panel cables from the cable guides.

Removing the front panel module



Figure 246: Removing the front panel module

i The front cover (tower server) / rack mounting frame (rack server) does not need to be removed in order to replace the front panel module. In the figures, the front cover / rack mounting frame has been removed for illustration purposes only.

- ▶ Press out on the locking latch to disengage the accessible drive locking bar (1).
- ▶ Fold up the accessible drive locking bar (2).
- ▶ Remove the front panel module (3).

Front panel and external connectors

- i** Unlocking and securing the front panel and accessible drives is illustrated by the example of tower servers. In case of rack servers, the accessible drive locking bar is located on the side of the drive bay. In this case, proceed as follows:

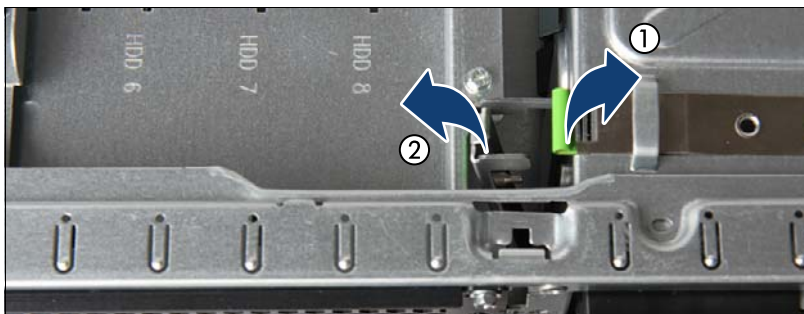

Figure 247: Removing the front panel module (rack systems)

- ▶ Pull up on the locking latch to disengage the accessible drive locking bar (1).
- ▶ Fold out the accessible drive locking bar (2).
- ▶ Remove the front panel module.

Removing cables from the front panel module



Figure 248: Front panel module - cable tie

- ▶ If necessary, cut the cable tie and remove it. The cable tie must not be replaced.

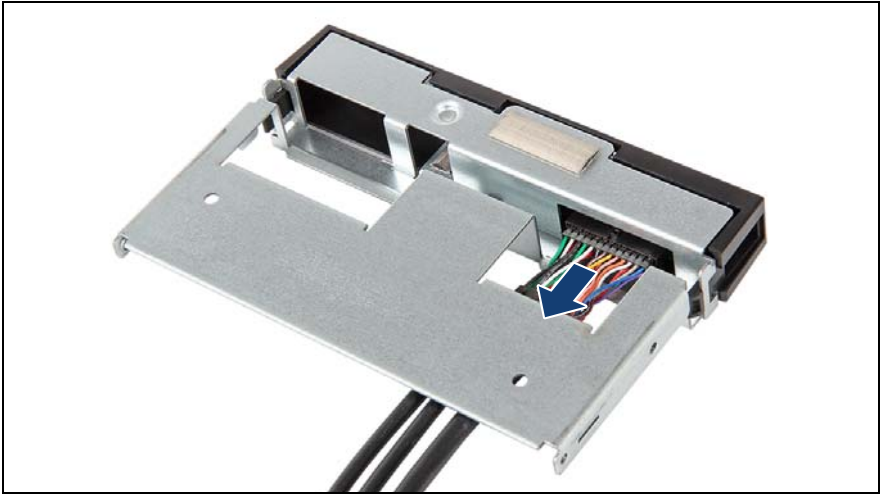

Figure 249: Removing the front panel cable

- ▶ Remove the front panel cable from the defective front panel module as shown.
- ▶ If the front LAN connector has been installed in the defective front panel module, remove the cable as described in section ["Removing the front LAN connector" on page 342](#).

13.1.1.3 Replacing the front panel module cover

i Removing and installing the front panel module cover is required if installing or removing the optional front LAN connector.

Removing the front panel module cover

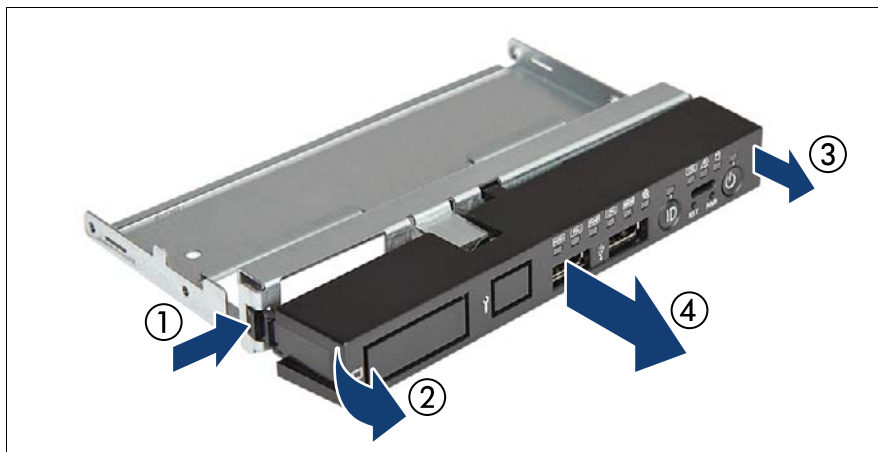

Figure 250: Removing the front panel module cover

- ▶ Press in on the locking latch on the left side of the front panel module cover to disengage the locking mechanism (1).
- ▶ Fold out the left side of the front panel module cover as shown (2).
- ▶ Disengage the right locking latch and pull off the front panel module cover (3).
- ▶ Remove the front panel module cover from the front panel frame.

Installing the front panel module cover

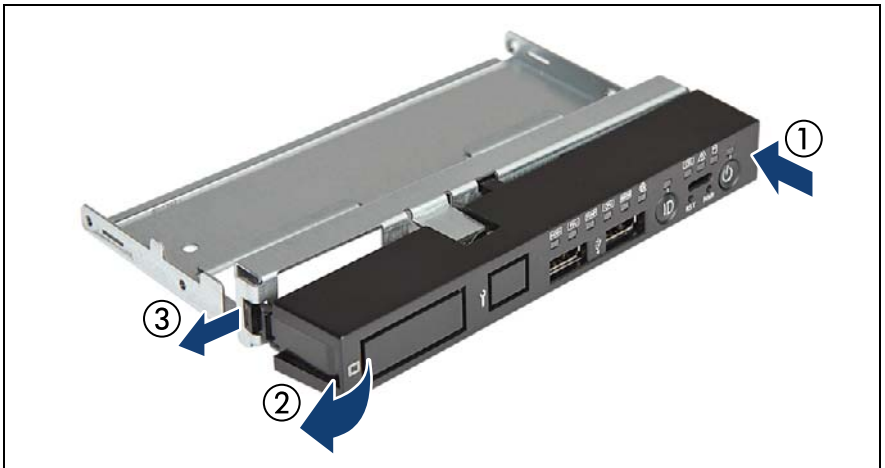

Figure 251: Installing the front panel module cover

- ▶ Hook the locking latch on the right side of the front panel module cover into the front panel frame (1).
- ▶ Fold in the front panel module cover (2) until the left locking latch engages with the front panel frame (3).

13.1.1.4 Installing the front panel module

Connecting cables to the front panel module

- ▶ If the front LAN connector is to be installed in the new front panel module, install the front LAN cable as described in section ["Installing the front LAN connector" on page 338](#).

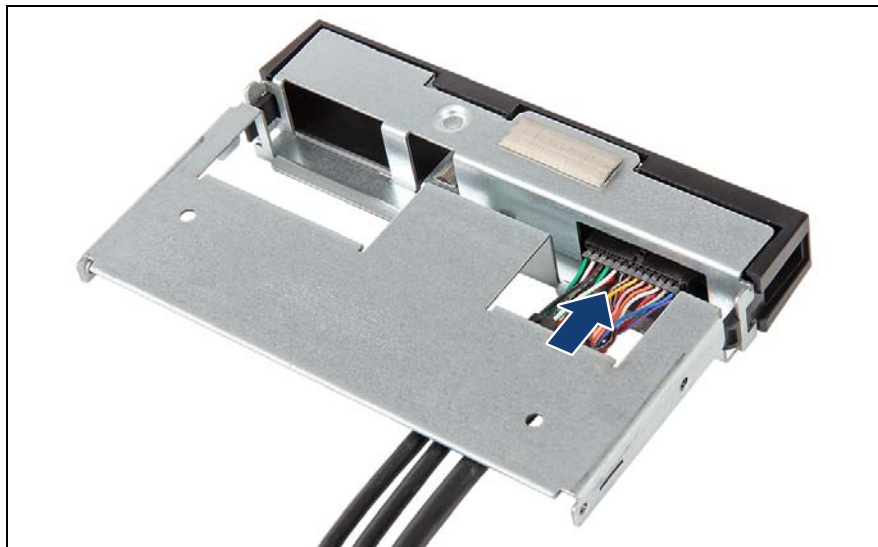

Figure 252: Connecting the front panel cable

- ▶ Connect the front panel cable to the new front panel module as shown.

Installing the front panel module

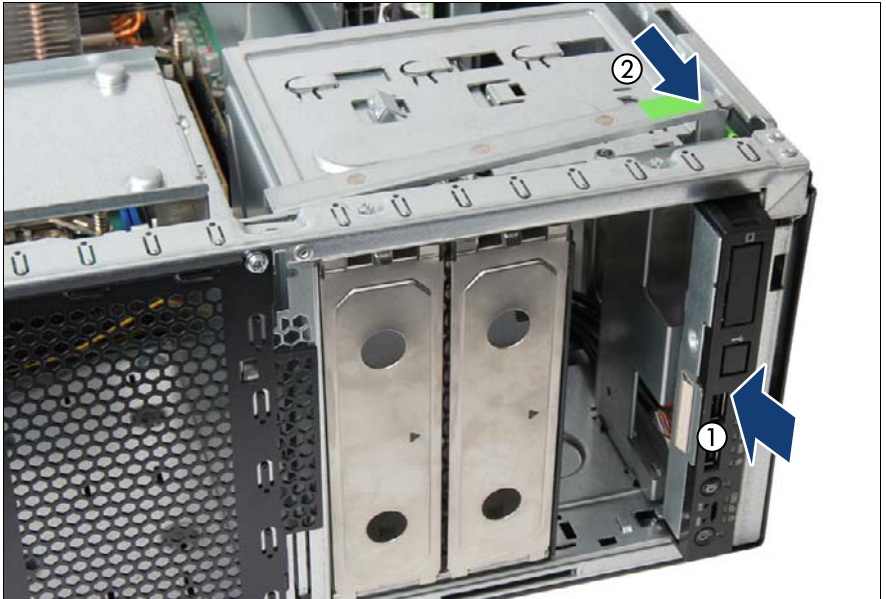

Figure 253: Installing the front panel module

- ▶ Insert the front panel module into its installation bay and carefully push in until the front screw hole on the front panel frame lines up with the centering pin on the locking bar (1).
- ▶ Close the locking bar until it locks in place (2).



Unlocking and securing the front panel and accessible drives is illustrated by the example of tower servers. In case of rack servers, the accessible drive locking bar is located on the side of the drive bay (see figure 247).

Front panel and external connectors

Connecting front panel cables to the system board

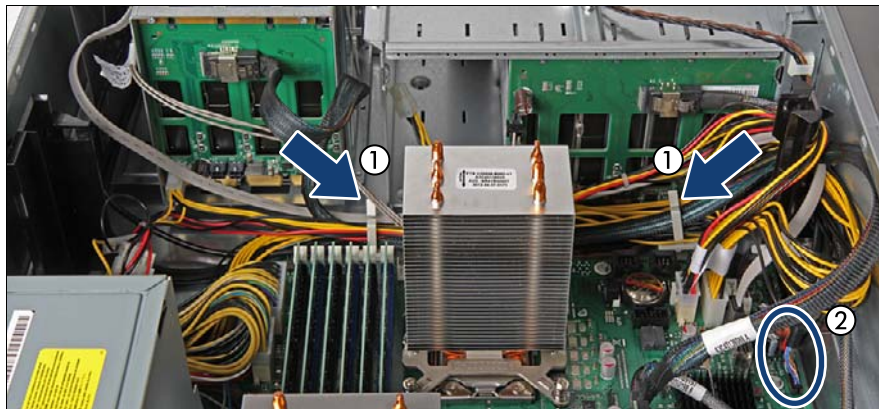

Figure 254: Securing front panel cables

- ▶ Run the front panel cables through the cable guides (1).
- ▶ Connect the front panel cable to the connector "Front Panel" on the system board.

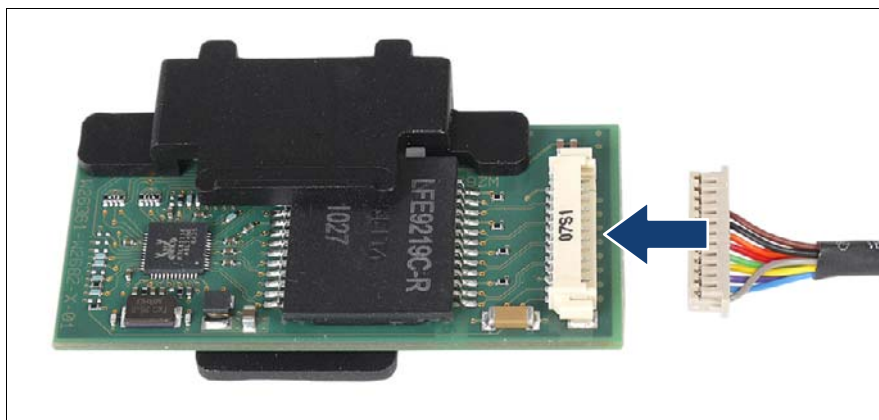

Figure 255: Connecting the front LAN cable to the front LAN board

- ▶ If applicable, connect the front LAN cable to the front LAN board.



Figure 256: Connecting the front LAN board to the system board

- ▶ If applicable, connect the front LAN board to the system board (1).
- ▶ If applicable, run the front LAN cable through the cable guide (2).

13.1.1.5 Concluding steps

- ▶ ["Installing the system fan holder" on page 77](#)
- ▶ ["Reassembling" on page 64](#)
- ▶ ["Connecting the server to the mains" on page 74](#)
- ▶ ["Switching on the server" on page 75](#)
- ▶ ["Verifying system information backup / restore" on page 89](#)
- ▶ Store your server's system information on the Chassis ID EPROM integrated into the front panel board. For further information on how to obtain and use the *ChassisId_Prom* Tool, refer to section ["Using the Chassis ID Prom Tool" on page 103](#).
- ▶ ["Enabling SVOM boot watchdog functionality" on page 94](#)
- ▶ ["Enabling BitLocker functionality" on page 100](#)

13.2 Front LAN connector

13.2.1 Installing the front LAN connector



Upgrade and Repair Unit (URU)



Hardware: 10 minutes

Tools: Slot screw driver

13.2.1.1 Preliminary steps

- ▶ ["Disabling BitLocker functionality" on page 79](#)
- ▶ ["Locating the defective server" on page 47](#)
- ▶ ["Shutting down the server" on page 50](#)
- ▶ ["Disconnecting the server from the mains" on page 50](#)
- ▶ ["Getting access to the component" on page 51](#)
- ▶ ["Removing the system fan holder" on page 76](#)

13.2.1.2 Installing the front LAN connector

- ▶ Disconnect the front panel cables from the system board as described in section ["Disconnecting cables" on page 327](#).
- ▶ Remove the front panel module from the chassis as described in section ["Removing the front panel module" on page 329](#).
- ▶ Remove the front panel module cover from the front panel frame as described in section ["Removing the front panel module cover" on page 332](#).



Figure 257: Breaking out the front LAN cover plate

- ▶ Break out the front LAN cover plate on the front panel cover.



Please note that once removed, the front LAN cover plate cannot be refitted.

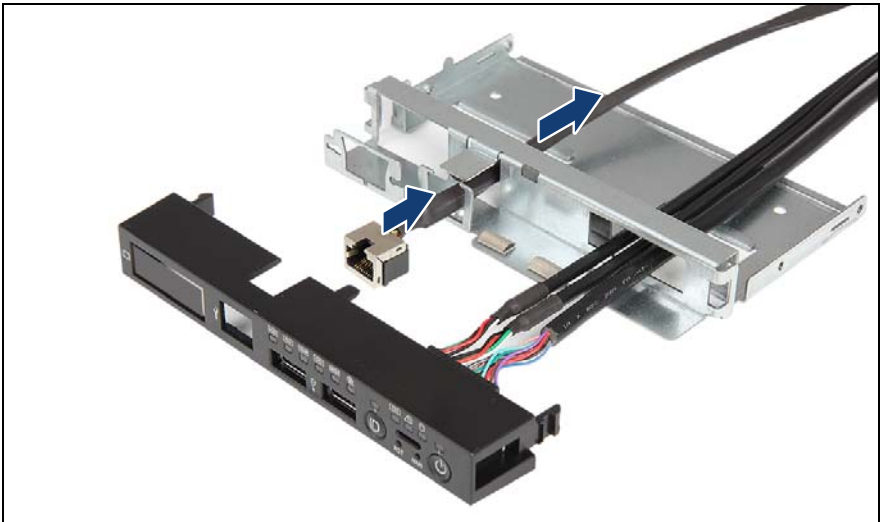

Figure 258: Installing the front LAN connector (A)

- ▶ Run the front LAN cable through the mounting bracket on the front panel frame as shown.

Front panel and external connectors

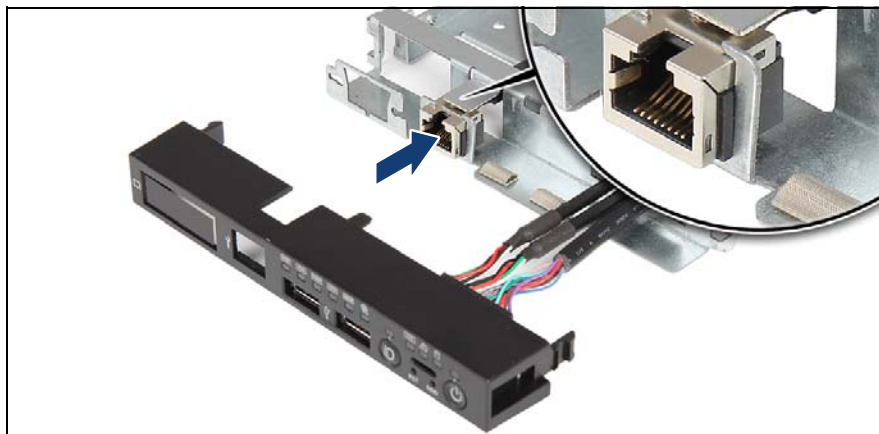

Figure 259: Installing the front LAN connector (B)

- ▶ Carefully snap the front LAN cable connector into the mounting bracket (see close-up).
- ▶ Install the front panel module cover on the front panel frame as described in section ["Installing the front panel module cover"](#) on page 333.
- ▶ Install the front panel module as described in section ["Installing the front panel module"](#) on page 335.

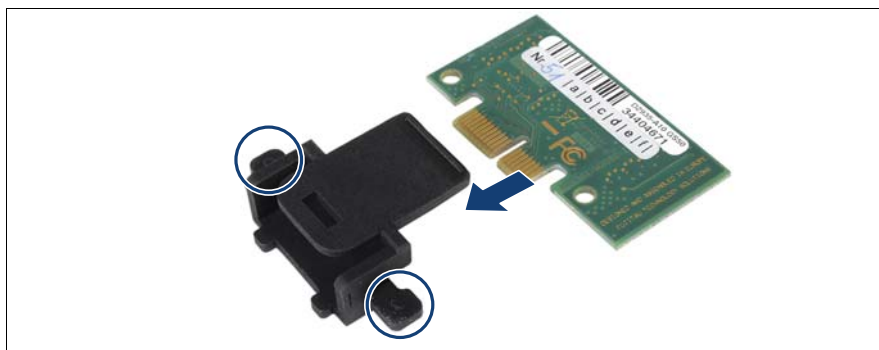

Figure 260: Assembling the front LAN board

- ▶ Insert and push the front LAN board into the front LAN holder until the two locking pins in the holder snap in place.
- ▶ Connect the front LAN board to connector "Front LAN" on the the system board.

- ▶ Connect the front panel cables to the system board as described in section ["Connecting front panel cables to the system board" on page 336](#).

13.2.1.3 Concluding steps

- ▶ ["Installing the system fan holder" on page 77](#)
- ▶ ["Reassembling" on page 64](#)
- ▶ ["Connecting the server to the mains" on page 74](#)
- ▶ ["Switching on the server" on page 75](#)
- ▶ ["Enabling BitLocker functionality" on page 100](#)

13.2.1.4 Using the front management LAN connector

In order to use the front management LAN connector to access the iRMC S3 management controller, please proceed as follows:

- ▶ Ensure that *Management LAN* has been enabled in the BIOS:
 - ▶ Enter the BIOS.
 - ▶ Select the *Server Mgmt* menu.
 - ▶ Under *iRMC LAN Parameters Configuration*, make sure that the *Management LAN* setting is set to *Enabled*.
 - ▶ Save your changes and exit the BIOS.



The front management LAN connector can be used to access the iRMC S3 with either of the *Management LAN Port* settings enabled, *Management* or *Shared*.

For detailed information on how to access the BIOS and modify settings, refer to the corresponding BIOS Setup Utility reference manual.

- ▶ Connect a client computer (e.g. notebook) to the front management LAN connector.



It is not possible to simultaneously access the iRMC S3 from the front and rear management LAN connectors. As soon as a LAN cable is connected to the front management LAN connector, the iRMC S3 cannot be accessed via the rear management LAN connector.

Front panel and external connectors

After removing the LAN cable from the front management LAN connector, the iRMC S3 will immediately become accessible via the rear management LAN connector again.

- ▶ Accessing the iRMC S3 using the front management LAN connector is only possible via the preset IP address 192.168.1.1 and cannot be configured otherwise.

Configure your client computer to use any static IP address on subnet 192.168.1.x (except 192.168.1.1) with subnet mask 255.255.255.0.

13.2.2 Removing the front LAN connector



Upgrade and Repair Unit (URU)



Hardware: 10 minutes

Tools: tool-less

13.2.2.1 Preliminary steps

- ▶ ["Disabling BitLocker functionality" on page 79](#)
- ▶ ["Locating the defective server" on page 47](#)
- ▶ ["Shutting down the server" on page 50](#)
- ▶ ["Disconnecting the server from the mains" on page 50](#)
- ▶ ["Getting access to the component" on page 51](#)
- ▶ ["Removing the system fan holder" on page 76](#)

13.2.2.2 Removing the front LAN connector

- ▶ Disconnect the front panel cables from the system board as described in section ["Disconnecting cables" on page 327](#).
- ▶ Remove the front panel module from the chassis as described in section ["Removing the front panel module" on page 329](#).
- ▶ Remove the front panel module cover from the front panel frame as described in section ["Removing the front panel module cover" on page 332](#).

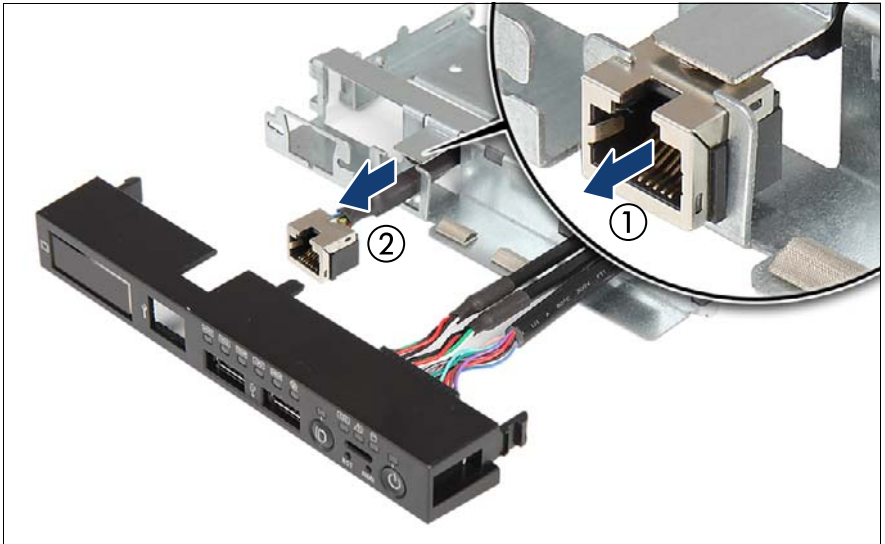

Figure 261: Removing the front panel connector

- ▶ Carefully unlatch the front LAN cable connector from the mounting bracket (1).
- ▶ Pull the front LAN cable out through the mounting bracket on the front panel frame and remove it (2).
- ▶ Install the front panel module cover on the front panel frame as described in section ["Installing the front panel module cover" on page 333](#).
- ▶ Install the front panel module as described in section ["Installing the front panel module" on page 335](#).

13.2.2.3 Concluding steps

- ▶ ["Installing the system fan holder" on page 77](#)
- ▶ ["Reassembling" on page 64](#)
- ▶ ["Connecting the server to the mains" on page 74](#)
- ▶ ["Switching on the server" on page 75](#)
- ▶ ["Enabling BitLocker functionality" on page 100](#)

13.2.3 Replacing the front LAN connector and board



**Upgrade and Repair Unit
(URU)**



Hardware: 15 minutes

Tools: tool-less

13.2.3.1 Preliminary steps

- ▶ ["Disabling BitLocker functionality" on page 79](#)
- ▶ ["Locating the defective server" on page 47](#)
- ▶ ["Shutting down the server" on page 50](#)
- ▶ ["Disconnecting the server from the mains" on page 50](#)
- ▶ ["Getting access to the component" on page 51](#)
- ▶ ["Removing the system fan holder" on page 76](#)

13.2.3.2 Replacing the front LAN connector and board

- ▶ Remove the front panel module as described in section ["Removing the front panel module" on page 327](#).
- ▶ Remove the defective front LAN connector as described in section ["Removing the front LAN connector" on page 342](#).
- ▶ Install the new front LAN connector as described in section ["Installing the front LAN connector" on page 338](#).
- ▶ Install the front panel module cover on the front panel frame as described in section ["Installing the front panel module cover" on page 333](#).
- ▶ Install the front panel module as described in section ["Installing the front LAN connector" on page 338](#).

13.2.3.3 Concluding steps

- ▶ ["Installing the system fan holder" on page 77](#)
- ▶ ["Reassembling" on page 64](#)
- ▶ ["Connecting the server to the mains" on page 74](#).

- ▶ ["Switching on the server" on page 75.](#)
- ▶ Inform the customer about changed WWN and MAC addresses. For further information, refer to section ["Looking up changed MAC / WWN addresses" on page 101.](#)
- ▶ After replacing the front LAN board in a server running Linux OS, update its MAC address in the related NIC definition file as described in section ["Updating the NIC configuration file in a Linux environment" on page 98.](#)
- ▶ If applicable, ["After replacing / upgrading LAN controllers" on page 104](#)
- ▶ ["Enabling BitLocker functionality" on page 100](#)

14 System board and components

Safety notes



CAUTION!

- Devices and components inside the server remain hot after shutdown. After shutting down the server, wait for hot components to cool down before installing or removing internal options.
- Circuit boards and soldered parts of internal options are exposed and can be damaged by static electricity. Always discharge static build-up (e.g. by touching a grounded object) before handling electrostatic-sensitive devices (ESDs).
- Do not touch the circuitry on boards or soldered parts. Hold circuit boards by their metallic areas or edges.
- For further information, please refer to chapter "[Important information](#)" on page 35.

14.1 Basic information

This section provides instructions for the system board and the following components:

- CMOS battery

CMOS memory (volatile BIOS memory) and the real-time clock are powered by a lithium coin cell (CMOS battery). This cell lasts up to ten years, depending on ambient temperature and use.

If the CMOS battery is depleted or falls below minimum voltage levels, it need to be replaced immediately.

- UFM (USB Flash Module)

The server can be equipped with a USB Flash Module (UFM).

- TPM (Trusted Platform Module)

The system board is optionally equipped with a Trusted Platform Module (TPM). This module enables programs from third party manufacturers to store key information, for example drive encryption using Windows BitLocker Drive Encryption.

- SCU (SKU) key

The SCU (SKU) key enables the SAS functionality of the Onboard controller.

14.2 Replacing the CMOS battery



Upgrade and Repair Unit (URU)



Hardware: 5 minutes

Tools: tool-less; recommended: tooth pick

Safety notes



CAUTION!

- The CMOS battery must be replaced with an identical battery or with a battery type recommended by the manufacturer.
- Keep lithium batteries away from children.
- Do not throw batteries into the trash can. Lithium batteries must be disposed of in accordance with local regulations concerning special waste.
- For further safety information, please refer to section "Environmental protection" in the PRIMERGY TX150 S8 / TX200 S7 Operating Manual.
- **Ensure to insert the CMOS battery the with the positive pole facing up!**

14.2.1 Preliminary steps

- ▶ ["Locating the defective server" on page 47](#)
- ▶ ["Shutting down the server" on page 50](#)
- ▶ ["Disconnecting the server from the mains" on page 50](#)
- ▶ ["Getting access to the component" on page 51](#)

14.2.2 Removing the CMOS battery



Figure 262: Replacing the CMOS battery

- ▶ Press out on the locking spring to eject the depleted CMOS battery (1).
- ▶ If the CMOS battery cannot be ejected this way, use a toothpick (recommended) or similar tool as a lever: Insert the toothpick between the battery and locking spring as shown (2).



CAUTION!

Do not use sharp-edged tools like screw drivers as they may damage system board components when slipping.

- ▶ Carefully pry the depleted CMOS battery out of its socket as shown (3).
- ▶ Remove the CMOS battery (4).



Do not throw the CMOS battery into the trash can. Lithium batteries must be disposed of in accordance with local regulations concerning special waste.

14.2.3 Installing the CMOS battery

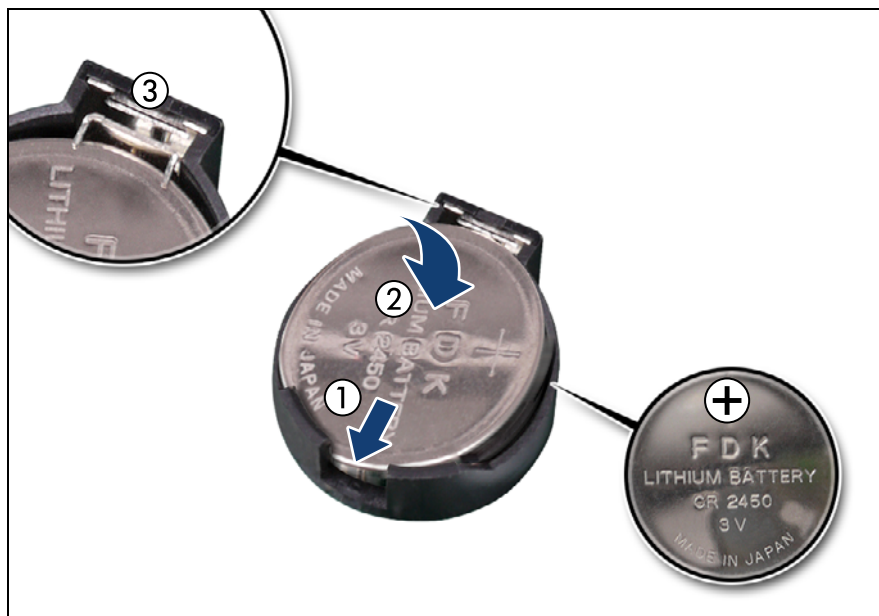

Figure 263: Installing the CMOS battery

- ▶ At a slight angle, fit the new CMOS battery into its socket as shown (1).



CAUTION!

Ensure to insert the CMOS battery with the positive pole (label side) facing up as shown (see close-up).

- ▶ Fold down the CMOS battery (2) until it locks in place.
- ▶ Ensure that the locking spring (3) is properly engaged.

14.2.4 Concluding steps

- ▶ Dispose of the CMOS battery in accordance with local regulations concerning special waste.
- ▶ ["Reassembling" on page 64](#)
- ▶ ["Connecting the server to the mains" on page 74](#)

- ▶ ["Switching on the server" on page 75](#)
- ▶ Verify whether the backup data on the Chassis ID EPROM has been restored to the system board as described in section ["Verifying system information backup / restore" on page 89](#).
- ▶ ["Verifying the system time settings" on page 96](#)

14.3 USB Flash Module (UFM)

14.3.1 Installing the UFM



Upgrade and Repair Unit (URU)



Hardware: 5 minutes
Software: 5 minutes

Tools: tool-less

14.3.1.1 Preliminary steps

- ▶ ["Disabling BitLocker functionality" on page 79](#)
- ▶ ["Disabling SVOM boot watchdog functionality" on page 80](#)
- ▶ ["Locating the defective server" on page 47](#)
- ▶ ["Shutting down the server" on page 50](#)
- ▶ ["Disconnecting the server from the mains" on page 50](#)
- ▶ ["Getting access to the component" on page 51](#)

System board and components

14.3.1.2 Installing the UFM

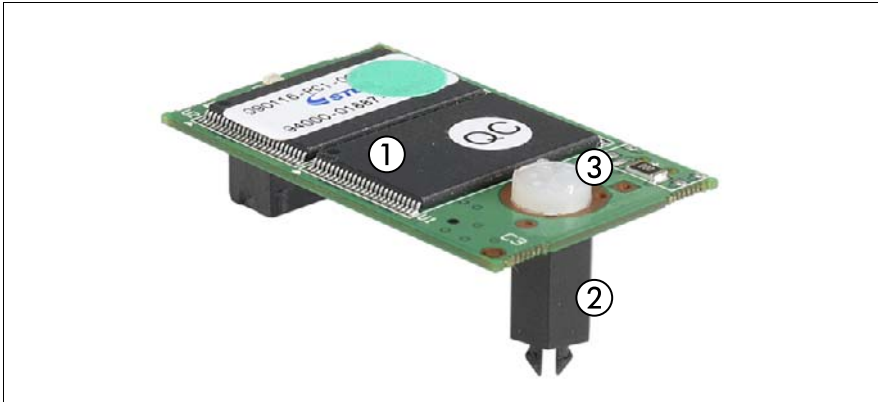

Figure 264: UFM kit

1	USB Flash Module (UFM)	2	UFM spacer
3	UFM nylon screw		

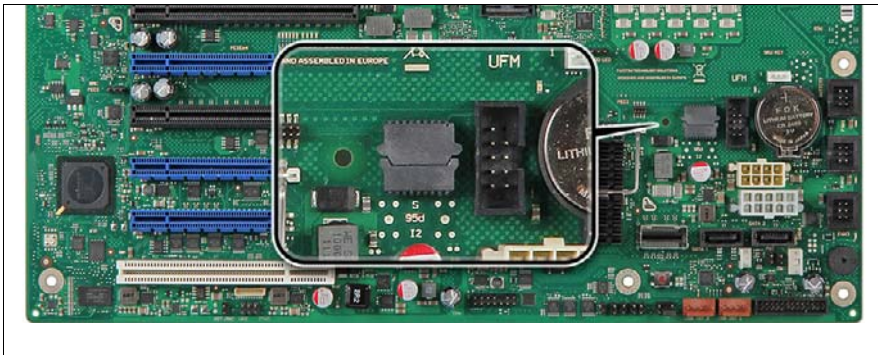

Figure 265: UFM mounting location

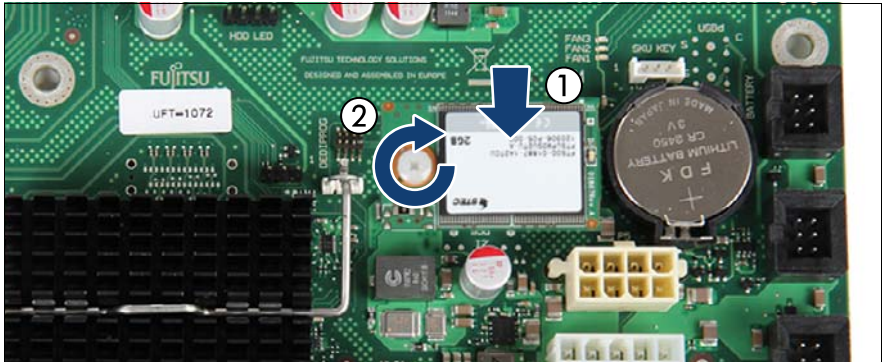

Figure 266: Installing the UFM

- ▶ Connect the UFM to the system board (1), snapping in the UFM spacer.
- ▶ Fasten the nylon screw (2).

14.3.1.3 Concluding steps

- ▶ ["Reassembling" on page 64](#)
- ▶ ["Connecting the server to the mains" on page 74](#)
- ▶ ["Switching on the server" on page 75](#)
- ▶ ["Enabling SVOM boot watchdog functionality" on page 94](#)
- ▶ ["Enabling BitLocker functionality" on page 100](#)

14.3.1.4 Software configuration

The UFM delivery set includes the "Recovery Tool CD" to setup the ESXi configuration. Proceed as follows:

- ▶ Switch on the server.
- ▶ Right after switching on the server, insert the "Recovery Tool CD" into the DVD drive and close the drive tray.
- ▶ The server should now boot from the "Recovery Tool CD".
- ▶ Follow the on-screen instructions.

14.3.2 Removing the UFM



Upgrade and Repair Unit
(URU)



Hardware: 5 minutes

Tools: Phillips PH1 / (+) No. 1 screw driver

14.3.2.1 Preliminary steps

- ▶ ["Disabling BitLocker functionality" on page 79](#)
- ▶ ["Locating the defective server" on page 47](#)
- ▶ ["Shutting down the server" on page 50](#)
- ▶ ["Disconnecting the server from the mains" on page 50.](#)
- ▶ ["Getting access to the component" on page 51.](#)

14.3.2.2 Removing the UFM

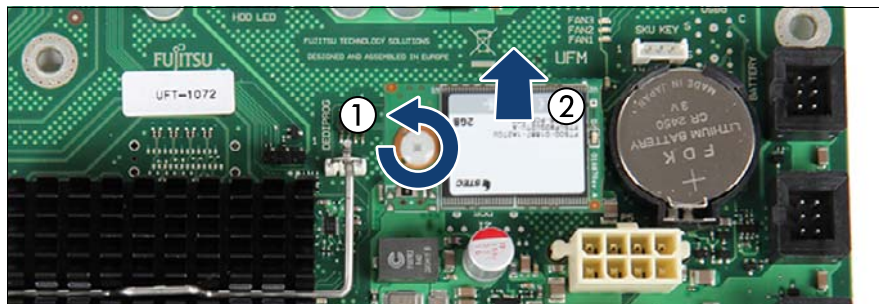

Figure 267: Removing the UFM (A)

- ▶ Remove the nylon screw (1).
- ▶ Disconnect and remove the UFM (2).



Figure 268: Removing the UFM (B)

- ▶ The UFM spacer remains on the system board.

14.3.2.3 Concluding steps

- ▶ ["Reassembling"](#) on page 64
- ▶ ["Connecting the server to the mains"](#) on page 74
- ▶ ["Switching on the server"](#) on page 75
- ▶ ["Enabling BitLocker functionality"](#) on page 100

14.3.3 Replacing the UFM



Upgrade and Repair Unit (URU)



Hardware: 10 minutes
Software: 5 minutes

Tools: – Phillips PH1 / (+) No. 1 screw driver
– combination pliers and flat nose pliers

14.3.3.1 Preliminary steps

- ▶ ["Disabling BitLocker functionality"](#) on page 79
- ▶ ["Disabling SVOM boot watchdog functionality"](#) on page 80
- ▶ ["Locating the defective server"](#) on page 47
- ▶ ["Shutting down the server"](#) on page 50
- ▶ ["Disconnecting the server from the mains"](#) on page 50
- ▶ ["Getting access to the component"](#) on page 51

System board and components

14.3.3.2 Removing the defective UFM

- ▶ Remove the UFM from the system board as described in section ["Removing the UFM" on page 354](#).
- ▶ The UFM spacer remains on the system board.

14.3.3.3 Installing the new UFM

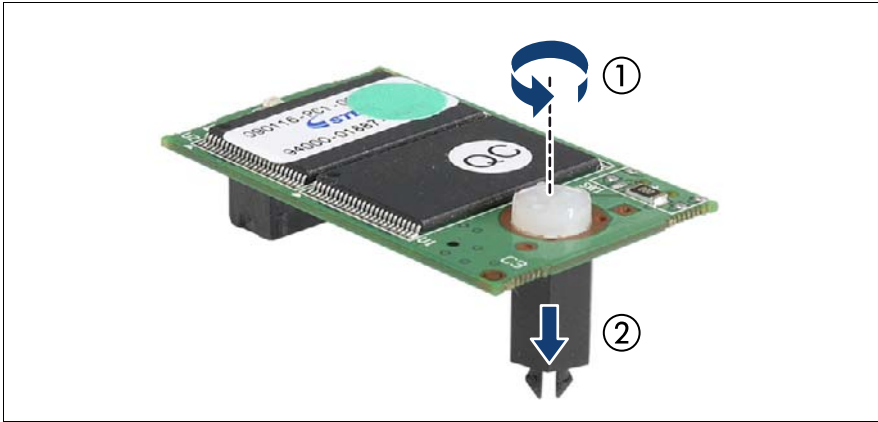

Figure 269: Preparing the new UFM

- ▶ Remove the nylon screw from the new UFM (1).
- ▶ Remove the UFM spacer (2).

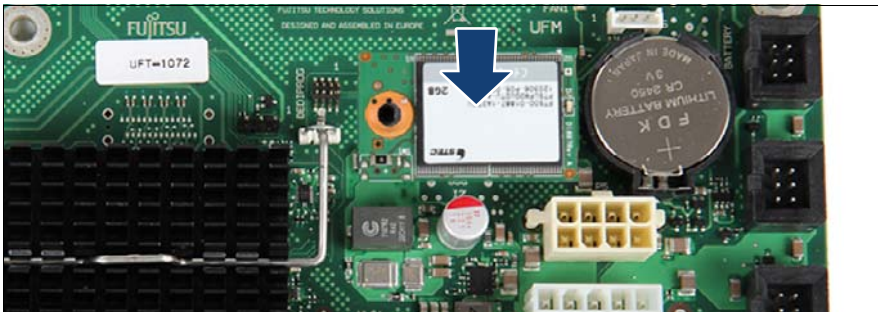

Figure 270: Installing the UFM (A)

- ▶ Fit the UFM on the UFM connector and the remaining UFM spacer.



Figure 271: Installing the UFM (B)

- ▶ Secure the UFM to the UFM spacer with the nylon screw.

Destroying the defective UFM



CAUTION!

The UFM contains customer information (e.g. IP address, license numbers). After replacing the UFM, hand the defective UFM over to the customer. If the customer requests disposal of the defective UFM, proceed as follows:

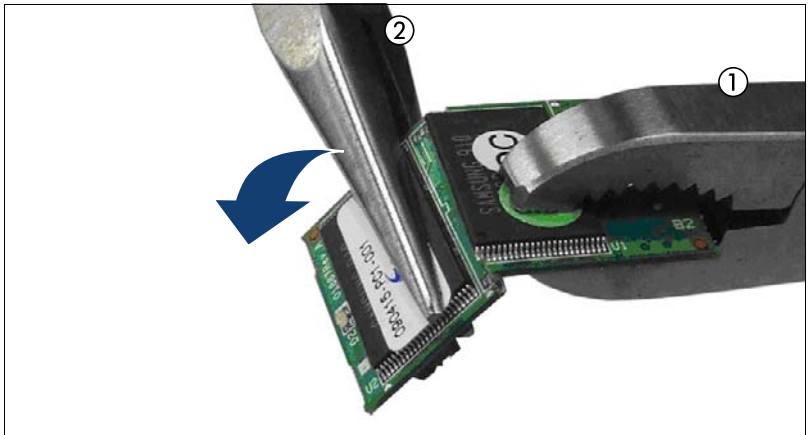

Figure 272: Destroying the defective UFM

- ▶ Use a pair of combination pliers (1) and flat nose pliers (2) to break the UFM in half as shown.

14.3.3.4 Concluding steps

- ▶ ["Reassembling" on page 64](#)
- ▶ ["Connecting the server to the mains" on page 74](#)
- ▶ ["Switching on the server" on page 75](#)
- ▶ ["Enabling SVOM boot watchdog functionality" on page 94](#)
- ▶ ["Enabling BitLocker functionality" on page 100](#)

14.3.3.5 Software configuration

The UFM delivery set includes the "Recovery Tool CD" to setup the ESXi configuration. Proceed as follows:

- ▶ Switch on the server.
- ▶ Right after switching on the server, insert the "Recovery Tool CD" into the DVD drive and close the drive tray.
- ▶ The server should now boot from the "Recovery Tool CD".
- ▶ Follow the on-screen instructions.

14.4 Trusted Platform Module (TPM)

14.4.1 Installing the TPM



Upgrade and Repair Unit (URU)



Hardware: 5 minutes
Software: 5 minutes

Tools: Phillips PH2 / (+) No. 2 screw driver

Installing the TPM:

- Bit screw driver
- TPM bit insert (*)

(*) For the Japanese market:

- TPM module fixing tool (S26361-F3552-L909)

14.4.1.1 Preliminary steps

- ▶ ["Disabling BitLocker functionality" on page 79](#)
- ▶ ["Locating the defective server" on page 47](#)
- ▶ ["Shutting down the server" on page 50](#)
- ▶ ["Disconnecting the server from the mains" on page 50](#)
- ▶ ["Getting access to the component" on page 51](#)

System board and components

14.4.1.2 Installing the TPM

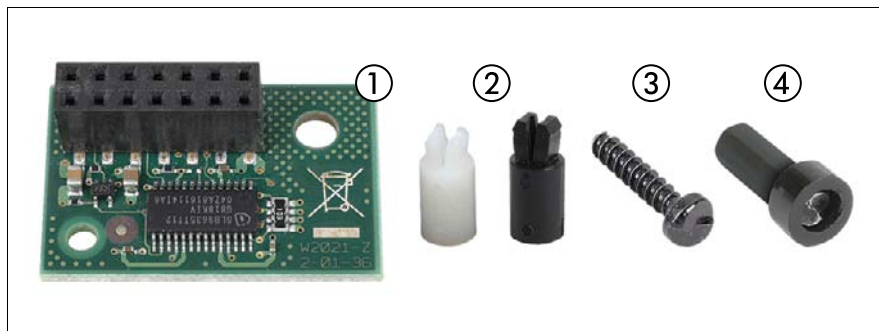



Figure 273: TPM kit

1	TPM (Trusted Platform Module)	3	Special screw for TPM
2	TPM spacer  The black TPM spacer is not used in this server.	4	TPM bit insert for TPM special screw

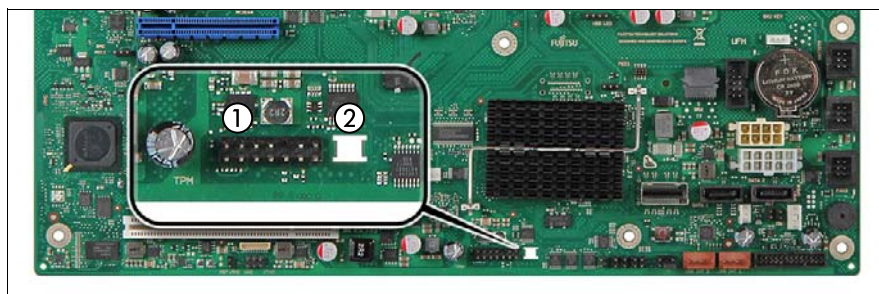

Figure 274: TPM mounting location

- 1: TPM connector
- 2: Cut-out for TPM spacer



Figure 275: Installing the TPM spacer

- ▶ Snap the TPM spacer into the cut-out in the system board.

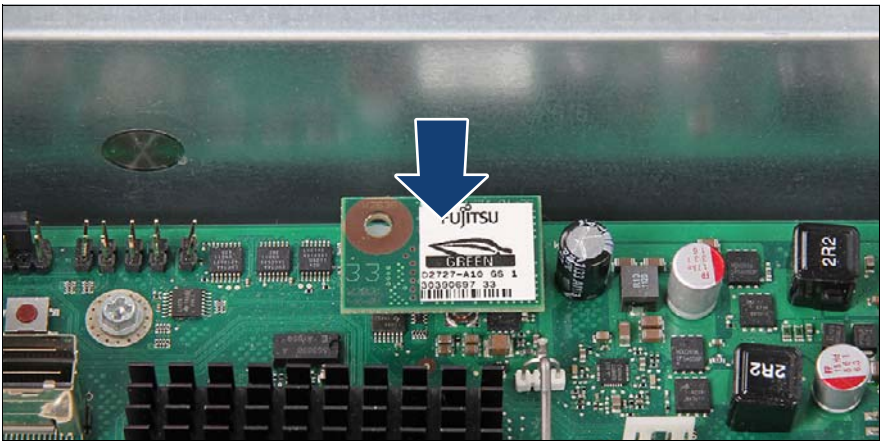

Figure 276: Installing the TPM

- ▶ Connect the TPM to the system board.

System board and components



Figure 277: TPM bit insert

- ▶ Attach the TPM bit insert or TPM module fixing tool (Japanese market) to a bit screw driver.

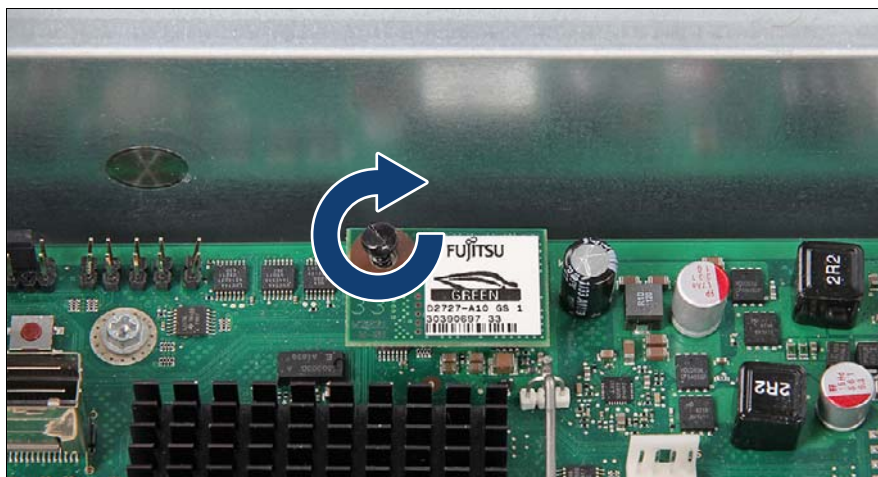

Figure 278: Securing the TPM

- ▶ Secure the TPM with the TPM screw using the TPM bit insert.



Do not fasten the screw too firmly. Stop as soon as the head of the screw lightly touches the TPM.

14.4.1.3 Concluding steps

- ▶ ["Reassembling" on page 64](#)
- ▶ ["Connecting the server to the mains" on page 74](#)
- ▶ Enable TPM in the system board BIOS. Proceed as follows:
 - ▶ Switch on or restart your server.
 - ▶ As soon as the startup screen appears, press the **[F2]** function key to enter the BIOS.
 - ▶ Select the *Advanced* menu.
 - ▶ Select the *Trusted Computing* submenu.
 - ▶ Set the *TPM Support* and *TPM State* settings to *Enabled*.
 - ▶ Under *Pending TPM operation*, select the desired TPM operation mode.
 - ▶ Save your changes and exit the BIOS.



For detailed information on how to access the BIOS and modify settings, refer to the corresponding BIOS Setup Utility reference manual.

- ▶ ["Switching on the server" on page 75](#)
- ▶ ["Enabling BitLocker functionality" on page 100.](#)

14.4.2 Removing the TPM



Field Replaceable Unit (FRU)



Hardware: 30 minutes

Tools: Removing the system board:

- Phillips PH2 / (+) No. 2 screw driver

Installing the TPM:

- Bit screw driver
- TPM bit insert (*)

(*) For the Japanese market:

- TPM module fixing tool (S26361-F3552-L909)



CAUTION!

Advise your contact persons that they must provide you with TPM backup copies. For security reasons, the TPM must be restored/re-saved by the customer. After installing a new system board, the TPM must be enabled. You may not clear the TPM data.

If the contact persons **DO NOT** have a backup copy available, inform them that replacing the TPM will cause to lose all data.

14.4.2.1 Preliminary steps

Before removing the TPM, perform the following steps:

- ▶ Before removing the TPM, it is necessary to remove BitLocker-protection from the computer and to decrypt the volume.

Ask the system administrator to turn off BitLocker-protection using the BitLocker setup wizard available either from the Control Panel or Windows Explorer:

- ▶ Open Bitlocker Drive Encryption by clicking the *Start* button, clicking *Control Panel*, clicking *Security*, and then clicking *Bitlocker Drive Encryption*.



Administrator permission required If you are prompted for an administrator password or confirmation, type the password or provide confirmation.

- ▶ To turn off BitLocker and decrypt the volume, click *Turn Off BitLocker*, and then click *Decrypt the volume*.



Decrypting the volume may be time-consuming. By decrypting the volume, all of the information stored on that computer is decrypted.

For further information on how to disable BitLocker drive encryption, please refer to the Microsoft Knowledge Base.

Fujitsu service partners will find additional information (also available in Japanese) on the Fujitsu Extranet web pages.

- ▶ Disable TPM in the system board BIOS. Proceed as follows:
 - ▶ Switch on or restart your server.
 - ▶ As soon as the startup screen appears, press the **[F2]** function key to enter the BIOS.

- ▶ Select the *Advanced* menu.
- ▶ Select the *Trusted Computing* submenu.
- ▶ Set the *TPM Support* and *TPM State* settings to *Disabled*.
- ▶ Save your changes and exit the BIOS.

i For detailed information on how to access the BIOS and modify settings, refer to the corresponding BIOS Setup Utility reference manual.

- ▶ ["Locating the defective server" on page 47](#)
- ▶ ["Shutting down the server" on page 50](#)
- ▶ ["Disconnecting the server from the mains" on page 50](#)
- ▶ ["Getting access to the component" on page 51](#)
- ▶ ["Removing the system fan holder" on page 76](#)

14.4.2.2 Removing the TPM

- ▶ ["Removing the defective system board" on page 375](#)
- ▶ Lay the system board on a soft, antistatic surface with its component side facing down.

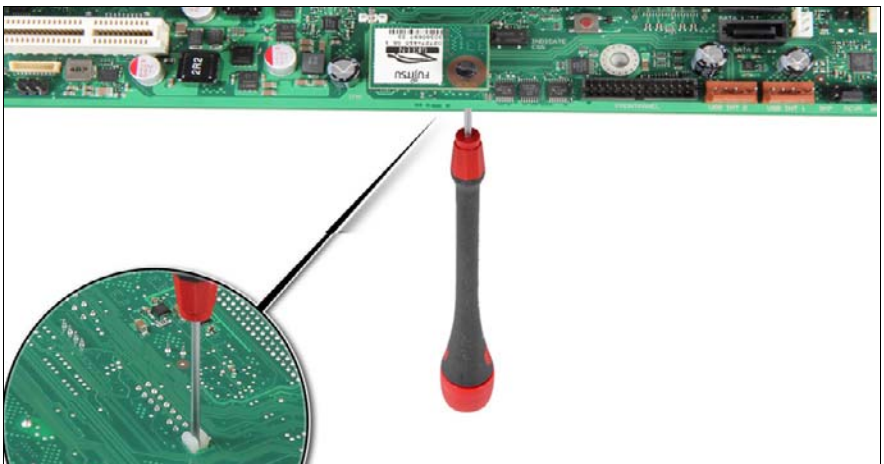

Figure 279: Removing the TPM screw

- ▶ Locate the slotted lower end of the TPM screw (1).

System board and components

- ▶ Carefully loosen the TPM screw using a thin slotted screw driver (e.g. watchmaker's screw driver) or the dedicated TPM screw driver (Japanese market) (2).



CAUTION!

Ensure to turn the screw **clockwise** in order to remove it!

Slowly and carefully increase the pressure on the screw until it begins to turn. The effort when loosening the screw should be as low as possible.

Otherwise the thin metal bar may break, rendering it impossible to loosen the screw.

- ▶ Remove the TPM screw.
- ▶ Remove the defective TPM on the upper side of the system board.

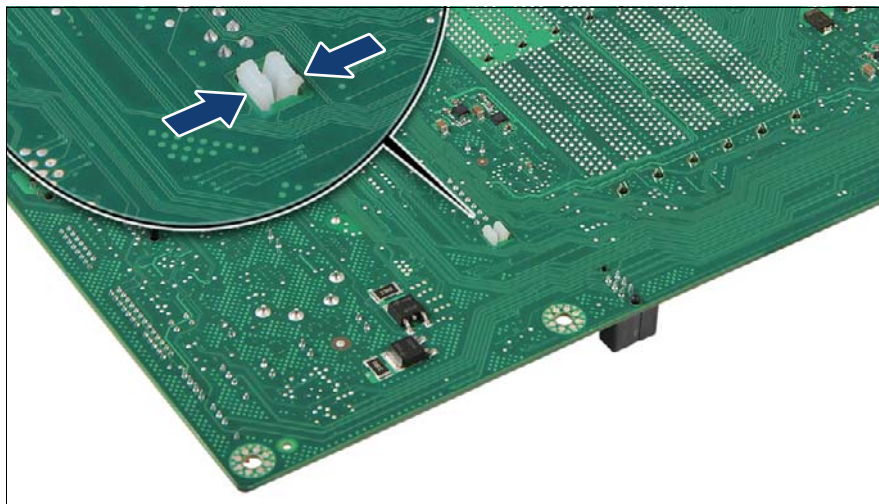

Figure 280: Removing the TPM spacer

- ▶ Using a small pair of combination pliers, press together the hooks on the TPM spacer (see close-up) and remove it from the system board.



If the TPM is to be replaced, the TPM spacer may remain on the system board.

14.4.2.3 Concluding steps

- ▶ "Installing the new system board" on page 379
- ▶ "Installing the system fan holder" on page 77
- ▶ "Reassembling" on page 64
- ▶ "Connecting the server to the mains" on page 74
- ▶ "Switching on the server" on page 75

14.4.3 Replacing the TPM



Field Replaceable Unit (FRU)



Hardware: 40 minutes

Tools: Removing the system board:

- Phillips PH2 / (+) No. 2 screw driver

Replacing the TPM:

- Bit screw driver
- TPM bit insert (*)
- thin slotted screw driver (2 x 0.4 mm) (*)

(*) For the Japanese market:

- Dedicated TPM screw driver (CWZ8291A)
- TPM module fixing tool (S26361-F3552-L909)



CAUTION!

Advise your contact persons that they must provide you with TPM backup copies. For security reasons, the TPM must be restored/re-saved by the customer. After installing a new system board, the TPM must be enabled. You may not clear the TPM data.

If the contact persons **DO NOT** have a backup copy available, inform them that replacing the TPM will cause to lose all data.

14.4.3.1 Preliminary steps

- ▶ ["Disabling BitLocker functionality" on page 79](#)
- ▶ ["Locating the defective server" on page 47](#)
- ▶ ["Shutting down the server" on page 50](#)
- ▶ ["Disconnecting the server from the mains" on page 50](#)
- ▶ ["Getting access to the component" on page 51](#)
- ▶ ["Removing the system fan holder" on page 76](#)

14.4.3.2 Removing the defective TPM

- ▶ Remove the TPM as described in section ["Removing the TPM" on page 363](#).
- ▶ Leave the TPM spacer on the system board when removing the defective TPM.

14.4.3.3 Installing the new TPM

- ▶ The TPM spacer is already present on the system board (see ["Installing the TPM spacer" on page 361](#)).
- ▶ Install the TPM as described in section ["Installing the TPM" on page 359](#).

14.4.3.4 Concluding steps

- ▶ ["Installing the system fan holder" on page 77](#)
- ▶ ["Reassembling" on page 64](#)
- ▶ ["Connecting the server to the mains" on page 74](#)
- ▶ ["Switching on the server" on page 75](#)
- ▶ ["Enabling BitLocker functionality" on page 100](#)

14.5 SCU (SKU) key

14.5.1 Installing the SCU (SKU) key



Upgrade and Repair Unit
(URU)



Hardware: 5 minutes

Tools: tool-less

14.5.1.1 Preliminary steps

- ▶ ["Disabling BitLocker functionality" on page 79](#)
- ▶ ["Locating the defective server" on page 47](#)
- ▶ ["Shutting down the server" on page 50](#)
- ▶ ["Disconnecting the server from the mains" on page 50](#)
- ▶ ["Getting access to the component" on page 51](#)

14.5.1.2 Installing the SCU (SKU) key

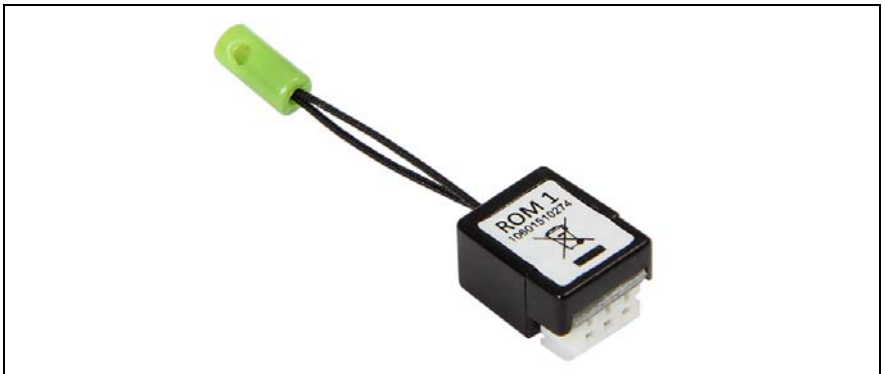

Figure 281: SCU (SKU) key

System board and components



Figure 282: SCU (SKU) key mounting location

- ▶ Locate the SCU (SKU) key mounting location on the system board.

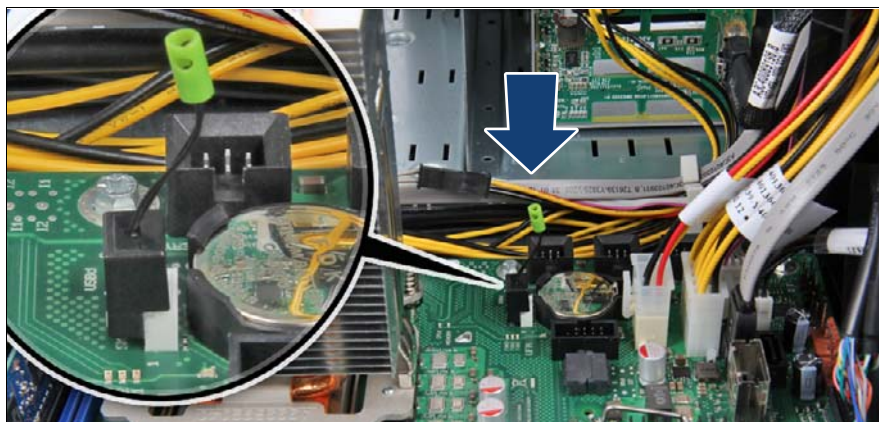

Figure 283: Installing the SCU (SKU) key

- ▶ Connect the SCU (SKU) key to connector "SKU Key".

14.5.1.3 Concluding steps

- ▶ ["Reassembling" on page 64](#)
- ▶ ["Connecting the server to the mains" on page 74](#)
- ▶ ["Switching on the server" on page 75](#)
- ▶ ["Enabling BitLocker functionality" on page 100](#)

14.5.2 Removing the SCU (SKU) key



Upgrade and Repair Unit
(URU)



Hardware: 5 minutes

Tools: tool-less

14.5.2.1 Preliminary steps

- ▶ ["Disabling BitLocker functionality" on page 79](#)
- ▶ ["Shutting down the server" on page 50](#)
- ▶ ["Disconnecting the server from the mains" on page 50](#)
- ▶ ["Getting access to the component" on page 51](#)

14.5.2.2 Removing the SCU (SKU) key

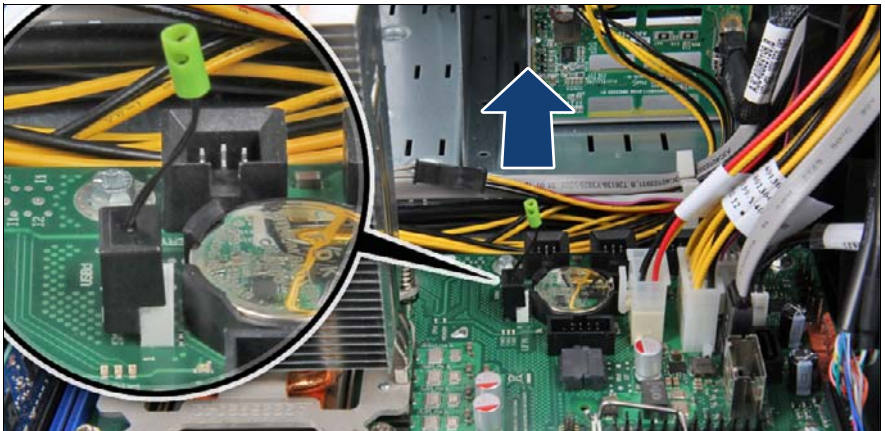

Figure 284: Removing the SCU (SKU) key

- ▶ Firmly pull up on the release lash until the SCU (SKU) key pops out of its connector.

14.5.2.3 Concluding steps

- ▶ ["Reassembling" on page 64](#)
- ▶ ["Connecting the server to the mains" on page 74](#)
- ▶ ["Switching on the server" on page 75](#)
- ▶ ["Enabling BitLocker functionality" on page 100](#)

14.5.3 Replacing the SCU (SKU) key



Upgrade and Repair Unit (URU)



Hardware: 5 minutes

Tools: tool-less

14.5.3.1 Preliminary steps

- ▶ ["Disabling BitLocker functionality" on page 79](#)
- ▶ ["Locating the defective server" on page 47](#)
- ▶ ["Shutting down the server" on page 50](#)
- ▶ ["Disconnecting the server from the mains" on page 50](#)
- ▶ ["Getting access to the component" on page 51](#)

14.5.3.2 Replacing the SCU (SKU) key

- ▶ ["Removing the SCU \(SKU\) key" on page 371](#)
- ▶ ["Installing the SCU \(SKU\) key" on page 369](#)

14.5.3.3 Concluding steps

- ▶ ["Reassembling" on page 64](#)
- ▶ ["Connecting the server to the mains" on page 74](#)
- ▶ ["Switching on the server" on page 75](#)
- ▶ ["Enabling BitLocker functionality" on page 100](#)

14.6 Replacing the system board



Field Replaceable Unit (FRU)



Hardware: 50 minutes
Software: 10 minutes

Tools: Replacing the system board:

- Phillips PH2 / (+) No. 2 screw driver
- Magnifying glass for inspecting processor socket springs (recommended)

Replacing the TPM:

- Bit screw driver
- TPM bit insert (*)
- thin slotted screw driver (2 x 0.4 mm) (*)

(*) For the Japanese market:

- Dedicated TPM screw driver (CWZ8291A)
- TPM module fixing tool (S26361-F3552-L909)

If a UFM is installed:

- Phillips PH1 / (+) No. 1 screw driver

Note on TPM



The system board can be equipped with an optional TPM (Trusted Platform Module). This module enables third party programs to store key information (e.g. drive encryption using Windows BitLocker Drive Encryption).

If the customer is using TPM functionality, the TPM has to be removed from the defective system board and connected to the new system board. For a detailed description, please refer to section "[Replacing the TPM](#)" on page 367.

The TPM is activated in the system BIOS.



CAUTION!

- Before replacing the system board, ask the customer whether TPM functionality is used.

System board and components

- If the customer is using TPM functionality, remove the TPM from the old system board and install it on the new system board.

Advise your contact persons that they must provide you with TPM backup copies. For security reasons, the TPM must be restored / re-saved by the customer. After installing a new system board the TPM must be enabled. You may not clear the TPM data.

If the contact persons **DO NOT** have a backup copy available, inform them that replacing the TPM will cause to lose all data.

Note on system information backup / restore



The front panel module contains the Chassis ID EPROM that contains system information like server name and model, housing type, serial number and manufacturing data.

To avoid the loss of non-default settings when replacing the system board, a backup copy of important system configuration data is automatically stored from the system board NVRAM to the Chassis ID EPROM. After replacing the system board the backup data is restored from the Chassis ID board to the new system board.



CAUTION!

For that reason the front panel module and system board must not be replaced simultaneously! In this case, restoring the system configuration data on the system board would fail.

Note on network settings recovery



When replacing network controllers or the system board, network configuration settings in the operating system will be lost and replaced by default values. This applies to all static IP address and LAN teaming configurations.

Ensure to note down your current network settings before replacing a controller or the system board.

14.6.1 Preliminary steps

 The TX200 S7 has the system board D3099 installed, the TX150 S8 has the system board D3079 installed. For differences between the two system boards refer to section ["Onboard connectors" on page 417](#).

The installing/removing procedure is the same for both system boards.

In the following description the system board D3099 of the TX200 S7 is shown.

- ▶ ["Note on network settings recovery" on page 374](#)
- ▶ ["Disabling BitLocker functionality" on page 79](#)
- ▶ ["Disabling SVOM boot watchdog functionality" on page 80](#)
- ▶ ["Locating the defective server" on page 47](#)
- ▶ ["Shutting down the server" on page 50](#)
- ▶ ["Disconnecting the server from the mains" on page 50](#)
- ▶ Disconnect all external cables.
- ▶ ["Getting access to the component" on page 51](#)
- ▶ ["Removing the system fan holder" on page 76](#)
- ▶ ["Removing the rear fan" on page 191](#) (if applicable)

14.6.2 Removing the defective system board

- ▶ Remove all cables from the system board.
- ▶ Remove the following components from the system board as shown in the related sections:
 - Heat sink: see [section "Removing processor heat sinks" on page 268](#)



Leave the processor on the defective board for now.

- Memory modules: refer to section ["Removing memory modules" on page 248](#)



Ensure to take note of the memory modules' mounting positions for reassembly.

System board and components

- Expansion cards: refer to the section ["Removing expansion cards" on page 212](#)



Ensure to take note of the controllers' mounting positions and cable connections for reassembly.

- UFM: refer to section ["Removing the UFM" on page 354](#)



Remove the UFM spacer from the defective system board and fasten it to the UFM with the UFM screw.

- SCU (SKU) key: refer to section ["Removing the SCU \(SKU\) key" on page 371](#)

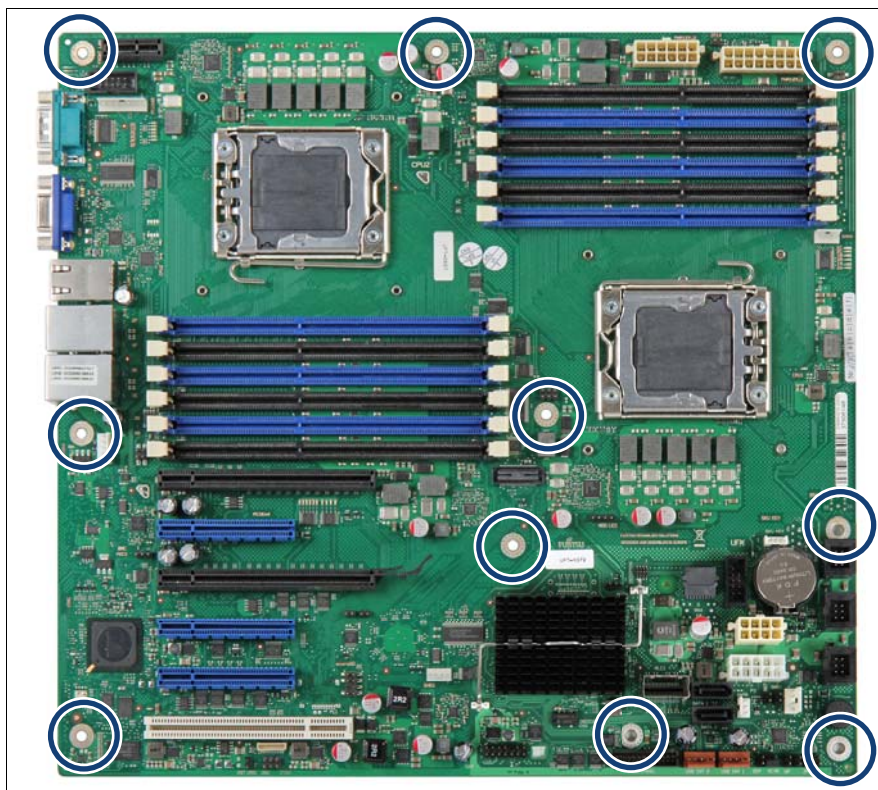

Figure 285: Removing the system board (A)

- ▶ Remove the ten screws (see circles).

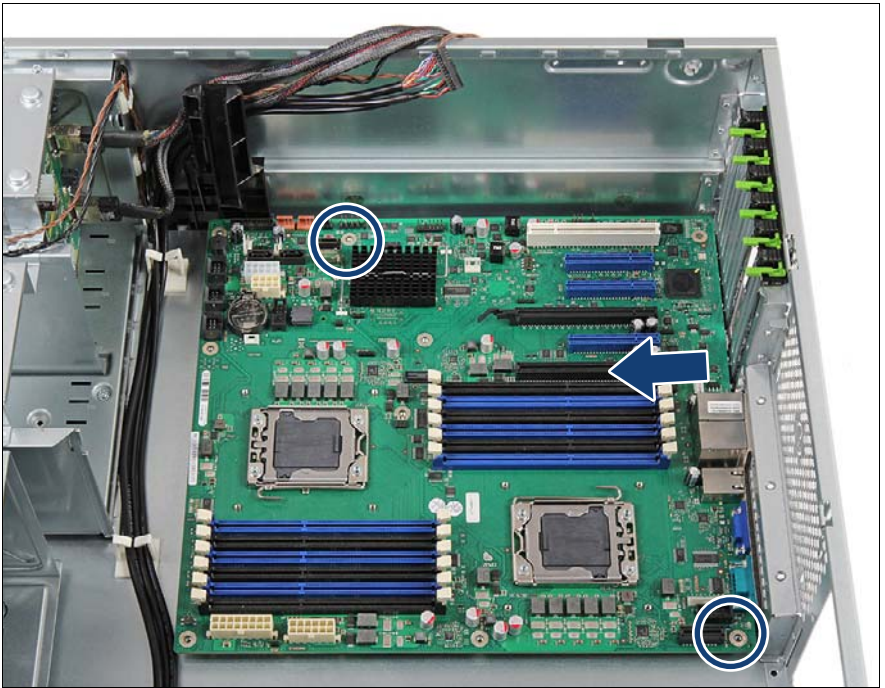

Figure 286: Removing the system board (B)

- ▶ Slightly lift up the system board by the memory module ejectors and a PCI slot in order to detach it from the centering bolts (see circles).
- ▶ Carefully shift the system board towards the server front until the plug shells disengage from the cut-outs in the connector panel.

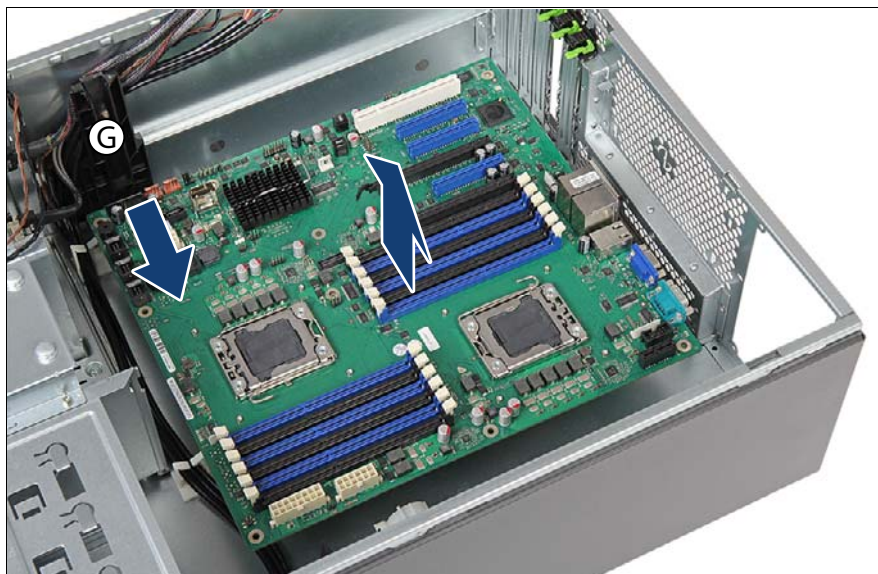

Figure 287: Removing the system board (C)

- ▶ Hold the defective system board by the memory module ejectors and a PCI slot and at a slight angle lift it out of the chassis. Make sure that the system board is shifted from the cable guide (G) before you lift it out.
- ▶ If applicable, remove the TPM as described in section ["Removing the TPM" on page 365](#).

14.6.3 Installing the new system board



Figure 288: Installing the system board (A)

- ▶ Hold the system board by the memory module ejectors and a PCI slot.



CAUTION!

- Do not lift or handle the system board by any of its heat sinks!
 - Ensure not to damage the EMI springs to comply with applicable EMC regulations and satisfy cooling requirements and fire protection measures.
- ▶ At a slight angle, lower the system board into the chassis. Make sure that the system board is shifted under the cable guide (G) before you lower it down.

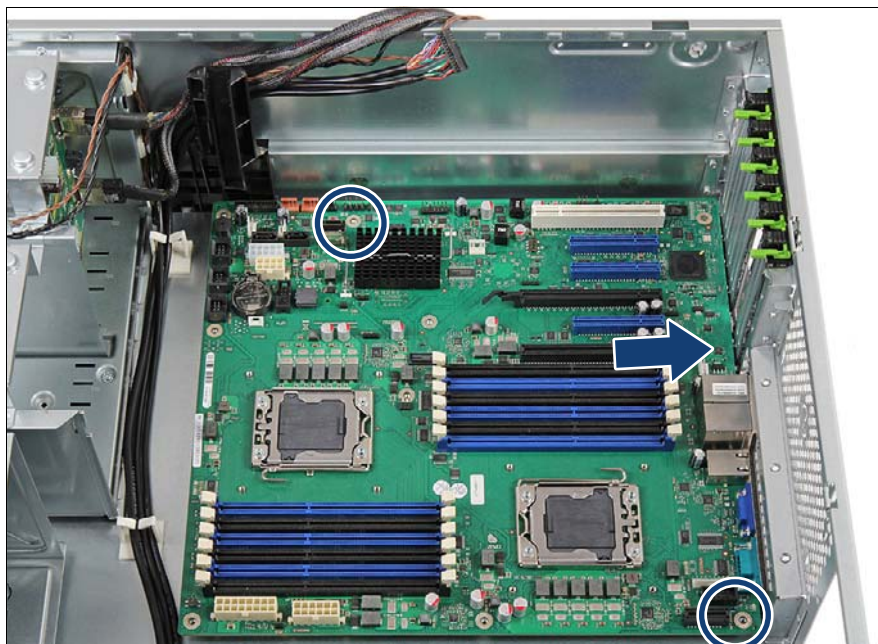

Figure 289: Installing the system board (B)

- ▶ Carefully shift the system board towards the server rear until the plug shells engage with the cut-outs in the connector panel.
- ▶ Lower the system board onto the centering bolts (see circles). Ensure that the system board is properly seated on both centering bolts.

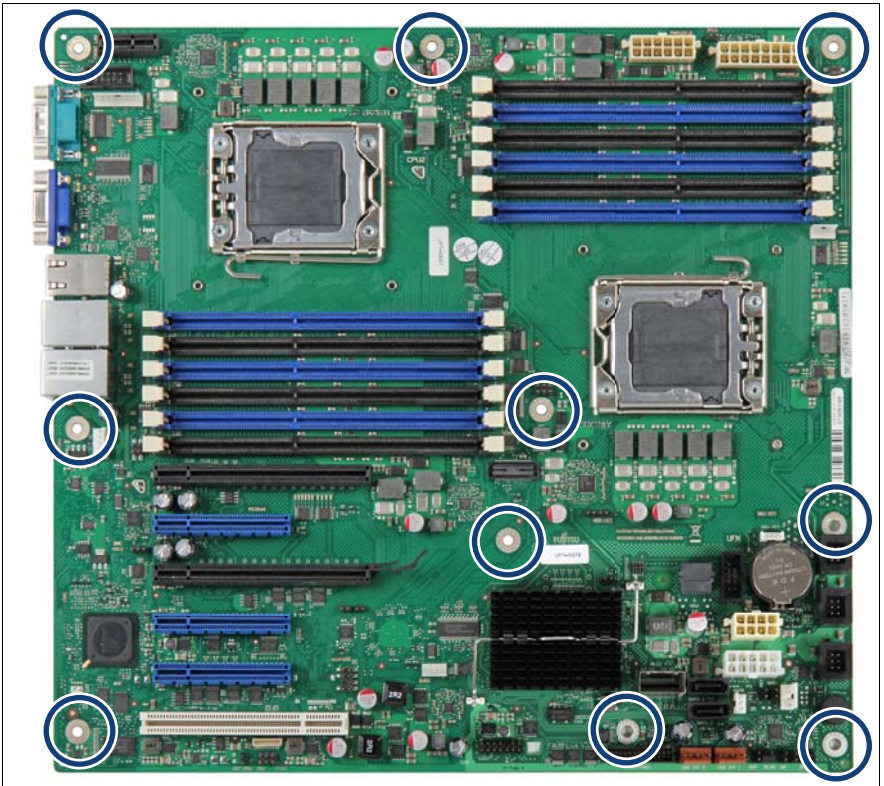

Figure 290: Installing the system board (C)

- ▶ Secure the system board with the ten screws (see circles).



Screw torque: 0.6 Nm (not applicable for the Japanese market)
Tighten the screws in a cross diagonal pattern.

- ▶ Verify the settings on the new system board (see figure ["Onboard settings" on page 426](#)).

Preparing the processor socket load plates on the new system board

- ▶ Remove the protective cover on the new system board as described in section ["Removing the protective cover" on page 254](#).

System board and components

Removing processors from the defective system board

- ▶ Carefully remove the processors from their sockets on the defective system board as described in section ["Removing processors" on page 258](#).



Remove and reinstall one processor at a time. Do not remove the second processor from the defective system board until the first processor has been installed on the new system board.

Installing processors on the new system board

- ▶ Install the processors on the new system board as described in section ["Installing processors" on page 253](#).

Installing protective socket covers on the defective system board



Since the defective system board is sent back for repair, protect the delicate processor socket springs with a socket cover.

- ▶ Install the protective cover on the new system board as described in section ["Installing the protective cover" on page 261](#).

Connecting cables to the new system board

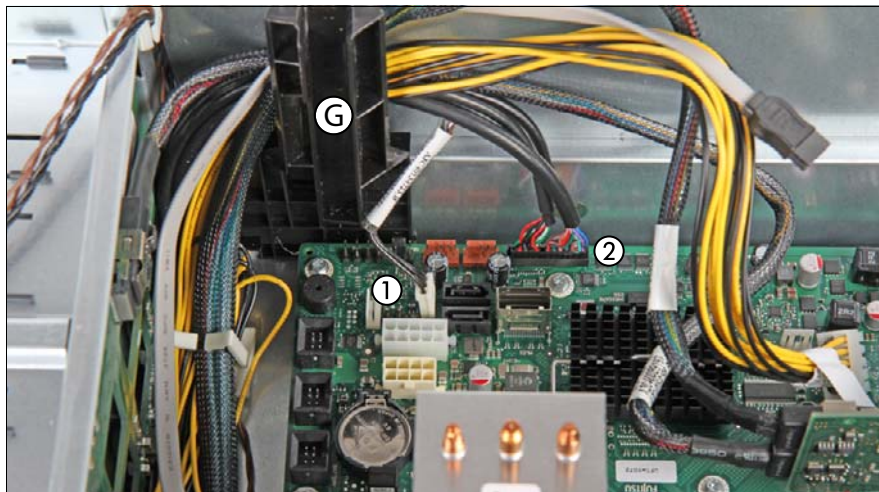

Figure 291: Connecting cables to the system board (A)

- ▶ Run the cables through the cable guide (G) as shown.

- ▶ Connect the intrusion switch cable to the system board connector "INTRUSION" (1) (see section ["Cabling plans" on page 403](#)).
- ▶ Connect the front panel cable to the system board connector "FRONTPANEL" (2) (see section ["Cabling plans" on page 403](#)).

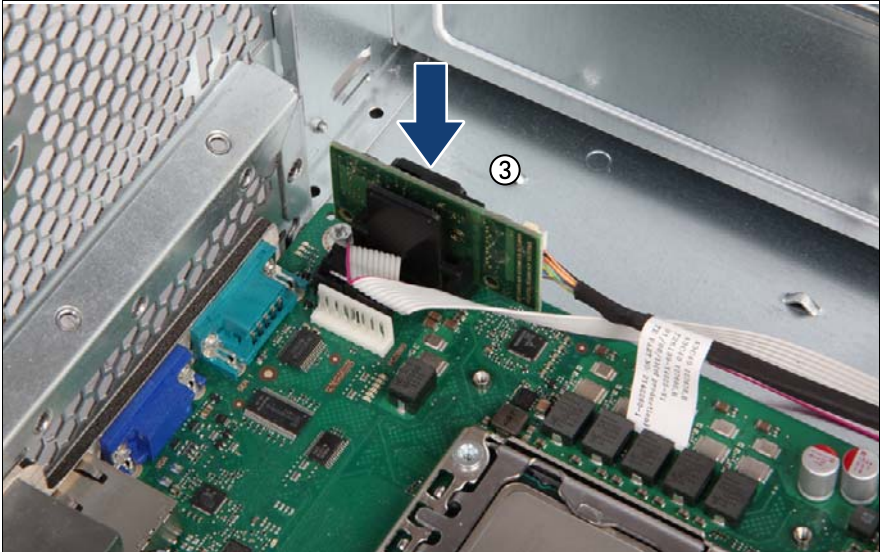

Figure 292: Connecting cables to the system board (B)

- ▶ If applicable, connect the front LAN board in the front LAN holder. Ensure that the front LAN board holder properly snaps into place.
- ▶ Connect the LAN board to the front LAN cable.
- ▶ Connect the front LAN board to the system board connector "FRONT LAN".



For further information on how to assemble the front LAN board and holder, refer to section ["Front LAN connector" on page 338](#).

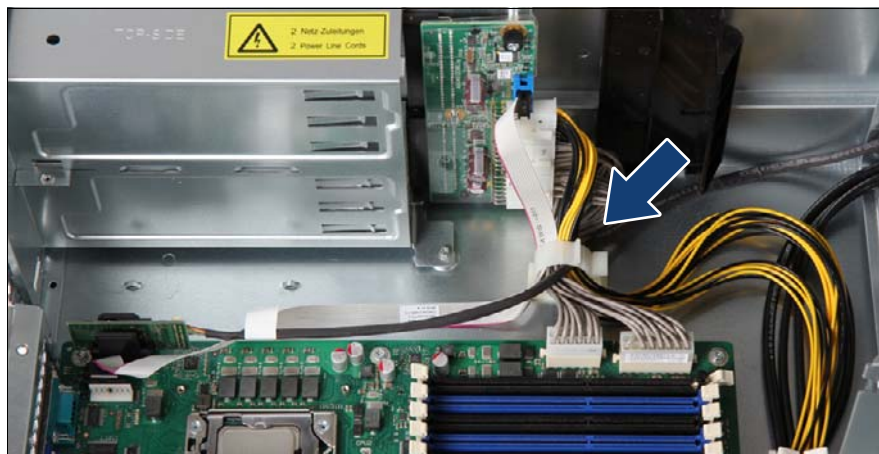

Figure 293: Connecting cables to the system board (C)

- ▶ If applicable, run the front LAN cable through the cable clamp as shown.

14.6.4 Concluding steps

- ▶ Reconnect all remaining cables to the system board. For a complete cabling overview, please refer to section ["Cabling plans" on page 403](#).
- ▶ Reinstall all remaining system board components as shown in the related sections:

- Heat sinks: refer to section ["Installing processor heat sinks" on page 266](#)
- Memory modules: refer to section ["Installing a memory module" on page 247](#)



Install all memory modules into their original slots.

- Expansion cards: refer to section ["Installing a memory module" on page 247](#)



Install all expansion cards into their original slots.

- UFM (if applicable): refer to section ["Installing the UFM" on page 351](#)
- TPM (if applicable): refer to section ["Installing the TPM" on page 359](#)

- ▶ If applicable, reinstall the rear fan as described in section ["Installing the rear fan" on page 187](#).
 - ▶ ["Installing the system fan holder" on page 77](#)
 - ▶ ["Reassembling" on page 64](#)
 - ▶ If applicable, activate TPM functionality in the system BIOS under *Security > TPM (Security Chip) Setting > Security Chip*. For more information, refer to the corresponding BIOS Setup Utility reference manual.
 - ▶ ["Connecting the server to the mains" on page 74](#)
 - ▶ ["Updating or recovering the system board BIOS and iRMC" on page 85](#)
 - ▶ Reconnect all external cables.
 - ▶ ["Switching on the server" on page 75](#)
 - ▶ Verify whether the backup data on the Chassis ID EPROM has been restored to the system board as described in section ["Verifying system information backup / restore" on page 89](#).
 - ▶ ["Verifying the system time settings" on page 96](#)
 - ▶ Inform the customer about changed WWN and MAC addresses. For further information, refer to section ["Looking up changed MAC / WWN addresses" on page 101](#).
 - ▶ After replacing the system board in a server running Linux OS, update the MAC address of the onboard network controller in the related NIC definition file as described in section ["Updating the NIC configuration file in a Linux environment" on page 98](#).
 - ▶ ["Enabling SVOM boot watchdog functionality" on page 94](#)
 - ▶ ["Enabling BitLocker functionality" on page 100](#)
 - ▶ Reconfigure your network settings in the operation system according to the original configuration of the replaced controller (expansion card or onboard).
-  Configuration of network settings should be performed by the customer.
- For further information, please refer to section ["Note on network settings recovery" on page 374](#).
- ▶ If applicable, ["After replacing the system board" on page 104](#)

15 Converting a tower model to a rack model



Upgrade and Repair Unit (URU)



Hardware: 20 minutes

Tools: – Phillips PH2 / (+) No. 2 screw driver – Slotted screw driver

Safety notes

For further information, please refer to chapter ["Important information"](#) on page 35.

15.1 Preliminary steps

- ▶ ["Shutting down the server"](#) on page 50
- ▶ ["Disconnecting the server from the mains"](#) on page 50
- ▶ Remove all external cables.
- ▶ ["Getting access to the component"](#) on page 51 including ["Removing the front cover"](#) on page 61



The front cover is no longer required.

- ▶ ["Removing the anti-tilt bracket"](#) on page 77

15.2 Converting a tower model to a rack model

Removing the right side cover



Figure 294: Removing the right side cover (A)

- ▶ Remove two screws on the server rear (see circles).



Figure 295: Removing the right side cover (B)

- ▶ Slide the right side cover towards the server rear as far as it will go (1).
- ▶ Remove the three hooks on the right side cover from the slots on the upper chassis edge:
 - ▶ Using a slotted screw driver, slightly pry up on the middle hook until it disengages (2).
 - ▶ Pull up on both ends of the right side cover to remove the left and right hooks from the slots on the upper chassis edge.
- ▶ Ensure that all cables and components are properly secured inside the server and that there are no loose pieces.
- ▶ Carefully turn the server upside down.
 - i** At least two people are needed to turn over a fully equipped server. Remove hard disk drives and power supply modules in order to facilitate the task.

Converting a tower model to a rack model

- ▶ Lift off and remove the right side cover as shown.

i The right side cover is no longer required.

- ▶ Leave the server in its upside down position.

Removing rubber feet

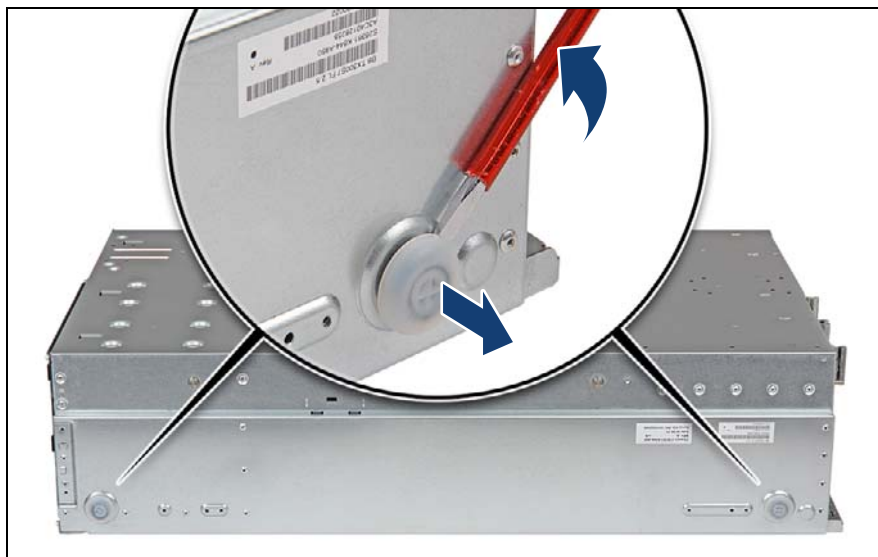

Figure 296: Removing rubber feet

- ▶ Using a slotted screw driver, slightly pry up on each rubber foot until it detaches.
- ▶ Bring the server back to its horizontal position.

i At least two people are needed to turn over a fully equipped server. Remove hard disk drives and power supply modules in order to facilitate the task.

Removing the accessible drive cage

- ▶ Remove the front panel module as described in section ["Removing the front panel module" on page 327](#).
- ▶ If applicable, remove all accessible drives as described in section ["Removing an accessible drive" on page 284](#).
- ▶ If applicable, remove an HDD extension box as described in section ["Removing an HDD extension box" on page 177](#).



Figure 297: Detaching the accessible drive cage (A)

- ▶ Remove two screws from the bottom side of the server as shown.
 - ▶ Bring the server back to its horizontal position.
- i** At least two people are needed to turn over a fully equipped server. Remove hard disk drives and power supply modules in order to facilitate the task.

Converting a tower model to a rack model



Figure 298: Detaching the accessible drive cage (B)

- ▶ Remove two screws from the right chassis edge (1).
- ▶ Remove two screws from the top edge of the chassis (2).

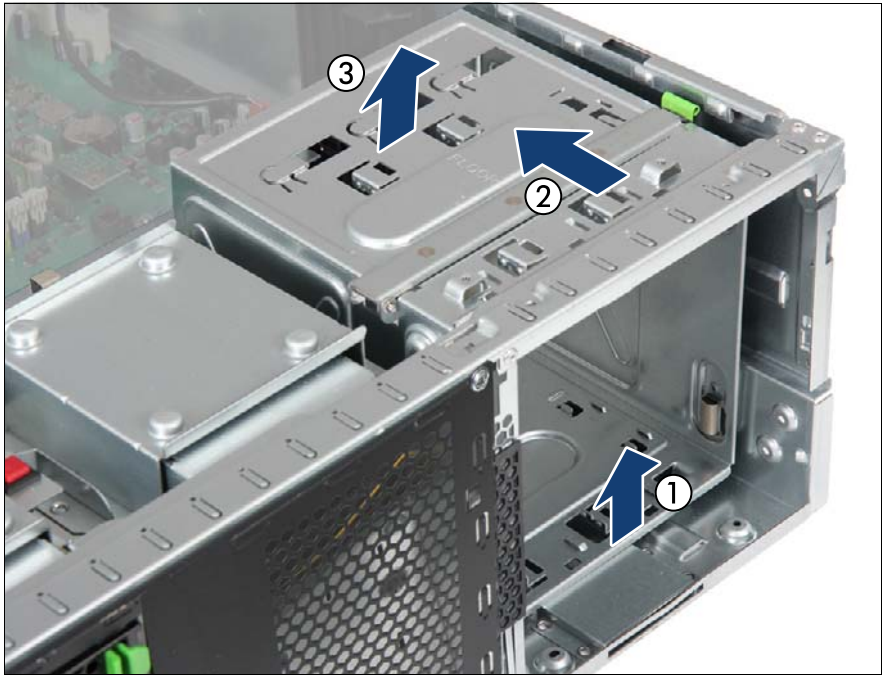

Figure 299: Removing the accessible drive cage

- ▶ Slightly lift up the accessible drive cage to disengage its front bottom edge from the slot on the chassis floor (1).
- ▶ Slide the accessible drive cover from under the chassis frame as shown (2).
- ▶ Lift the accessible drive cage out of the chassis (3).

Converting a tower model to a rack model

Converting the accessible drive cage

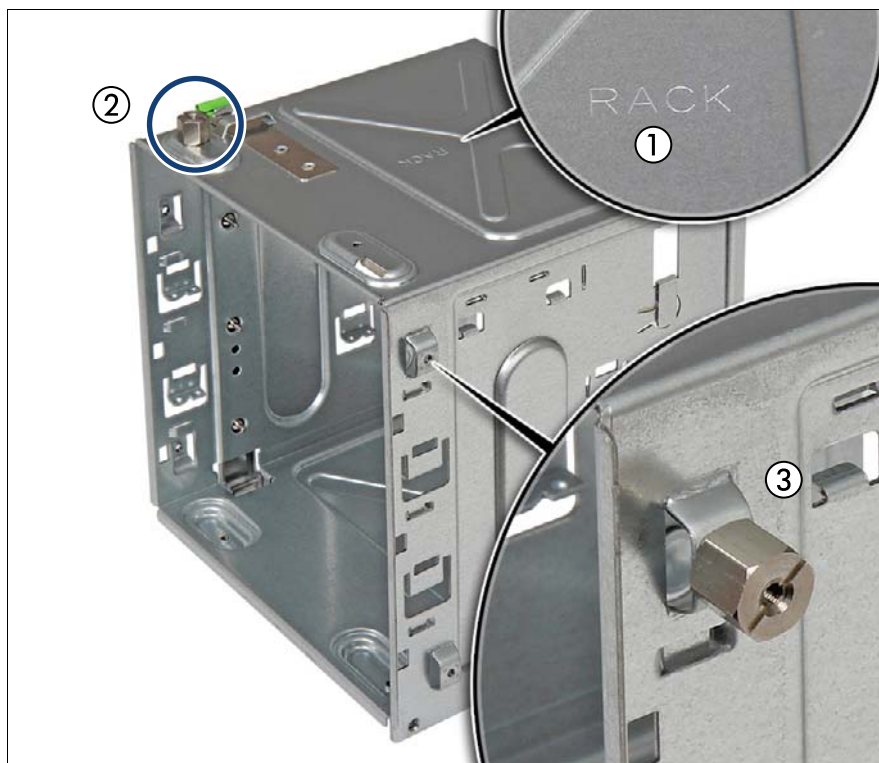

Figure 300: Converting the accessible drive cage

- ▶ Turn the accessible drive cover with its "RACK" stamping facing up (1, see close-up).
- ▶ Remove the threaded bolt from the upper edge of the accessible drive cage (2).
- ▶ Reinstall the threaded bolt on the side of the accessible drive cage as shown (3, see close-up).

Reinstalling the accessible drive cage

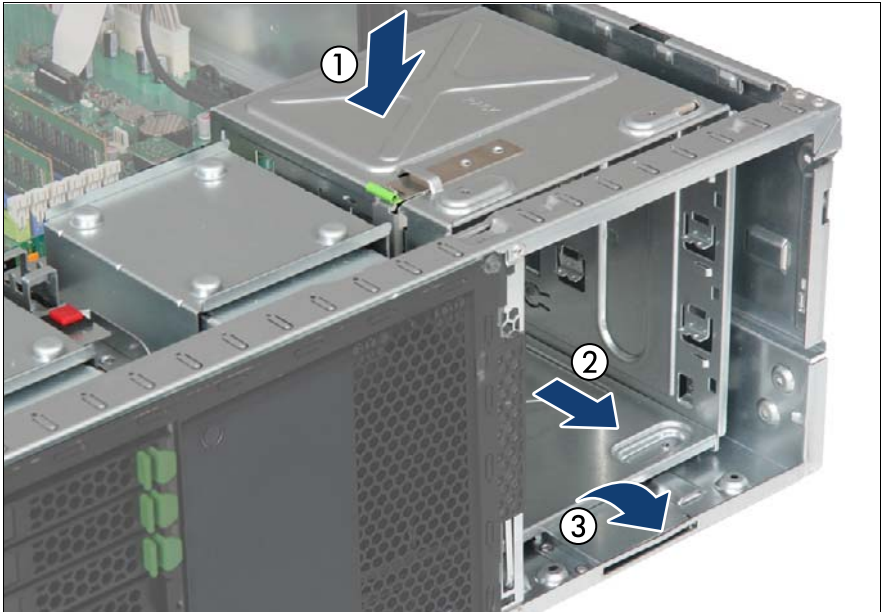

Figure 301: Mounting the accessible drive cage

- ▶ With its "RACK" stamping facing up, lower the accessible drive cage into the chassis (1).
- ▶ Slide the accessible drive cage towards the server front as far as it will go (2).
- ▶ Ensure that the front bottom edge on the accessible drive cover properly engages in the slot in the chassis floor (3).

Converting a tower model to a rack model



Figure 302: Securing the accessible drive cage (A)

- ▶ Secure the accessible drive cage with two screws (1).
- ▶ Secure the accessible drive cage with two screws (2).
- ▶ Ensure that all cables and components are properly secured inside the server and that there are no loose pieces.



Figure 303: Securing the accessible drive cage (B)

- ▶ Carefully turn the server upside down.



At least two people are needed to turn over a fully equipped server. Remove hard disk drives and power supply modules in order to facilitate the task.

- ▶ Secure the accessible drive cage with two screws.



Note the correct screw positions: The screw hole on the right that has been used in the tower configuration remains empty.

- ▶ Install the front panel module as described in section ["Installing the front panel module" on page 334](#).
- ▶ If applicable, install all accessible drives as described in section ["Installing an accessible drive" on page 280](#).
- ▶ If applicable, install an HDD extension box as described in section ["Installing an HDD extension box" on page 170](#).

Preparing the intrusion switch

- ▶ Remove the intrusion switch module as described in section ["Removing the defective intrusion switch cable" on page 407](#).



It is not necessary to disconnect the intrusion switch cable from the system board.

- ▶ Attach a rubber bumper to the front intrusion switch and reinstall the intrusion switch module as described in section ["Installing the new intrusion switch cable" on page 410](#).

Reinstalling accessible drives

- ▶ Reinstall the front panel (rotated by 90 degrees) as described in section ["Installing the front panel module" on page 334](#).
- ▶ Reinstall all accessible drives into their original bays (rotated by 90 degrees). Reconnect the cables (see section ["Cabling plans" on page 403](#)).
- ▶ Reinstall all accessible drive filler covers and front covers as described in section ["Installing accessible drive dummy covers" on page 284](#).

Converting a tower model to a rack model

Assembling the rack front cover



Figure 304: Rack mounting brackets with quick release levers



The rack front cover consists of a plastic frame and two rack mounting brackets with quick release levers.

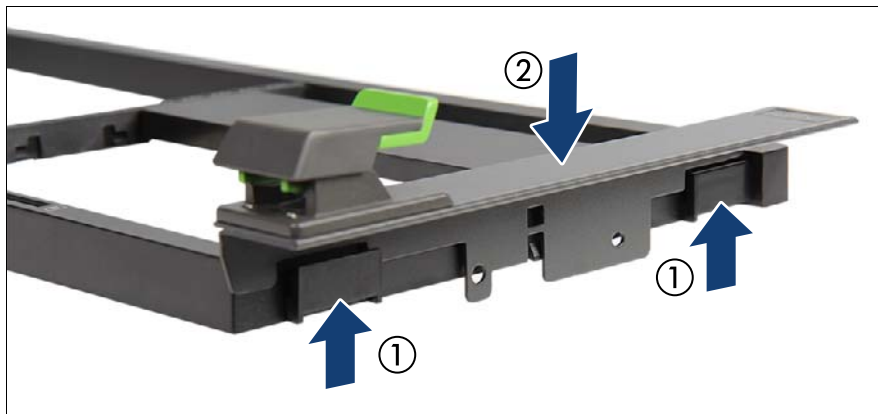



Figure 305: Installing rack mounting brackets

- ▶ Fit the rack mounting bracket on the two hooks on the rack front bezel (1).
- ▶ Firmly press down on the rack mounting bracket until it is fully seated in the rack front bezel (2).
- ▶ Mount the second rack mounting bracket accordingly.



Figure 306: Installing accessible drive dummy covers

- ▶ If available, reinstall all accessible drive dummy covers into their original locations (rotated by 90 degrees):
 - ▶ Ensure that an accessible drive filler cover has been installed in every empty drive bay.
 - ▶ Turn the front cover face down.
 - ▶ Join the two lugs on one edge of the accessible drive cover with the right inner edge of the front cover (1).
 - ▶ Fold down the accessible drive cover until it snaps in place (2).
-  Use the dummy covers that have been removed from the front cover during the preliminary steps.
- ▶ Install the rack front cover as described in section ["Installing the rack front cover" on page 65](#).
- ▶ If applicable, remove all accessible drives or dummy covers as described in section ["Removing an accessible drive" on page 284](#).

15.3 Concluding steps

- ▶ ["Installing the top cover" on page 66](#)



Figure 307: Attaching the caution label

- ▶ Attach the caution label on the left front edge of the top cover as shown.
- ▶ Mount the support bracket and rack mounting rails in the rack as described in the "Rack Mounting Kit - RMK-F2 Drop-In" Mounting Instructions.



The document is available online or from the ServerView Suite DVD 2 supplied with your PRIMERGY server. The printed poster is contained in the rack mounting kit.

- ▶ Mount the server in the rack as described in section ["Mounting the server in the rack" on page 67](#).
- ▶ Reconnect all external cables.
- ▶ ["Connecting the server to the mains" on page 74](#)
- ▶ ["Switching on the server" on page 75](#)
- ▶ Update your server's chassis information on the Chassis ID EPROM integrated into the front panel board. For further information on how to obtain and use the *ChassisId_Prom* Tool, refer to section ["Using the Chassis ID Prom Tool" on page 103](#).
- ▶ Change the chassis model setting to "rack server" as described in section ["Specifying the chassis model" on page 105](#).

16 Cabling

Safety notes



CAUTION!

- Always hold cables by their connectors when disconnecting them. Never pull on the cable to disconnect cables.
- Ensure that none of the cables are scraped, strained or otherwise damaged while replacing system components.
- Immediately replace cables with damaged shielding.
- Always use shielded network cables.

16.1 List of used cables



The numbers in the cable list correspond to those shown in the cabling plans.

No.	Name	Part number (T26139-)	Routing
C1	CBL_PDB_MoBo_HDD_Pow	Y4030-V101	Power backplane to system board and HDD backplane
C2	CBL_PDB_MoBo_Pow14	Y3952-V511	Power backplane to system board
C3	CBL_PDB_MoBo_Pow12	Y4030-V2	Power backplane to system board
C4	CBL_PDB_MoBo_Sig10	Y3956-V2	Power backplane to system board
C5	CBL_MoBo_DVD	Y3939-V301	ODD to system board or SAS backplane
C6	CBL_MoBo_HDD Box_Pow	Y3939-V401	System board to HDD extension box
C10	CBL_FRONTANEL 650	Y4015-V2	Front panel module to system board
C12	CBL_INTRUSION_SW_New	Y3922-V121	Server side and front to system board
C17	CBL_LSD 700	Y3718-V301	LSD to system board
C19	CBL_FrontLAN 600	Y4025-V1	Server front to front LAN board
C20	CBL_SAS470x1	Y3963-V103	SAS backplane to SAS controller

Table 5: List of used cables

Cabling

No.	Name	Part number (T26139-)	Routing
C21	CBL_SAS36TO36	Y3963-V117	SAS backplane to SAS controller
C22	CBL_BBU08 160	Y3987-V3	BBU to SAS controller
C22	CBL_FBU 170	Y4032-V3	FBU to TFM
C23	CBL_DVD	Y3928-V205	System board to DVD
C24	CBL_SAS BOX 2x3,5	Y3963-V203	To 2x 3.5 HDD extension box
C32	CBL_SATA_Full_Pow 410	Y3930-V601	
C33	CBL_SATA_Slim_Pow 400	Y3986-V302	
C34	CBL_SAS_Dev_PowSig 700	Y3969-V401	
C35	CBL_PATA_Dev_Pow 410	Y4029-V1	
C36	cbl_USB	Y3973-V96	USB backup drive to system board
	CBL_LTO	Y3969-V202	

Table 5: List of used cables

16.2 Cabling plans

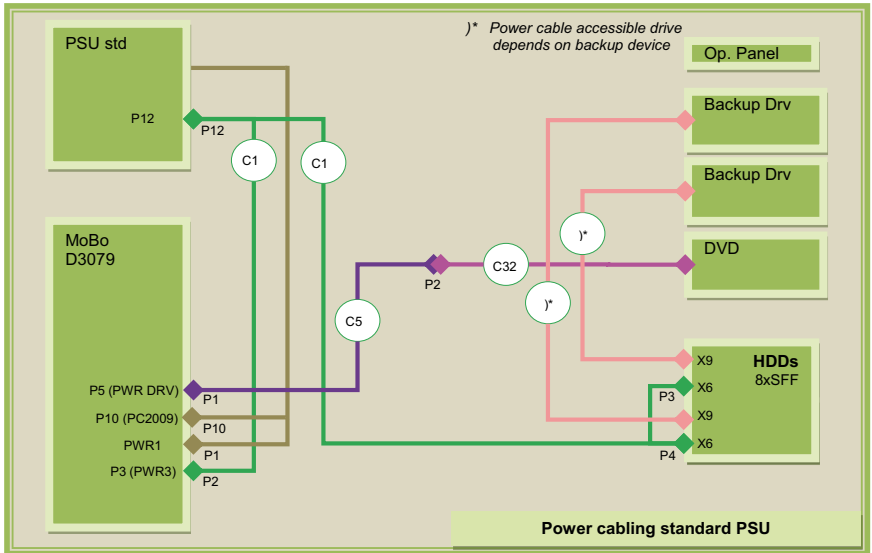

Figure 308: Cabling standard PSU -TX150 S8

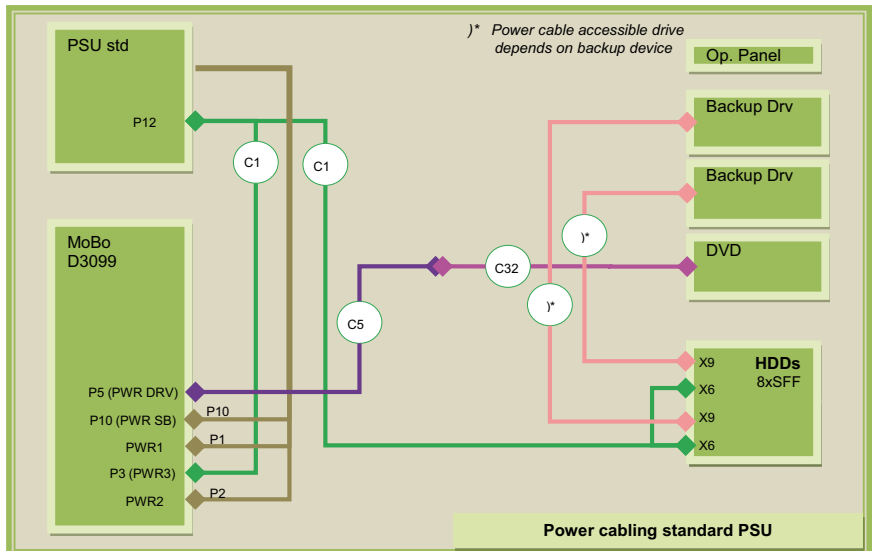

Figure 309: Cabling standard PSU -TX200 S7

Cabling

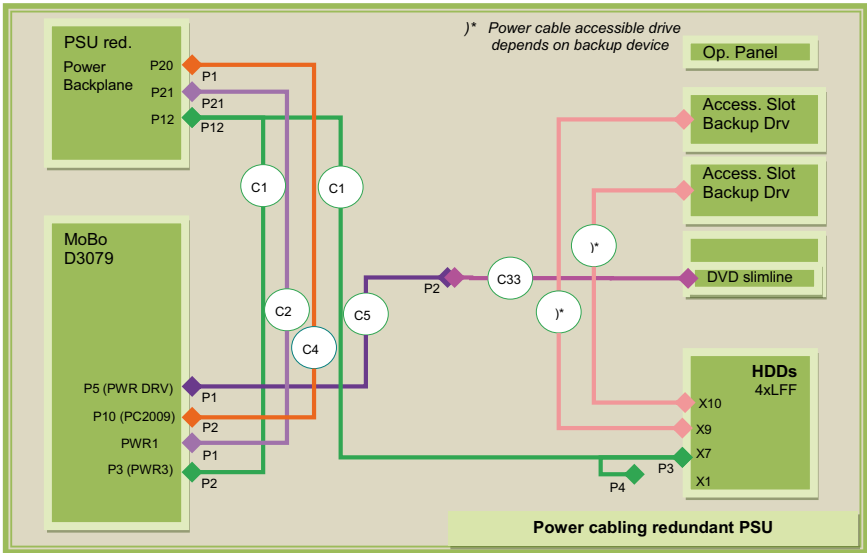

Figure 310: Cabling redundant PSU -TX150 S8

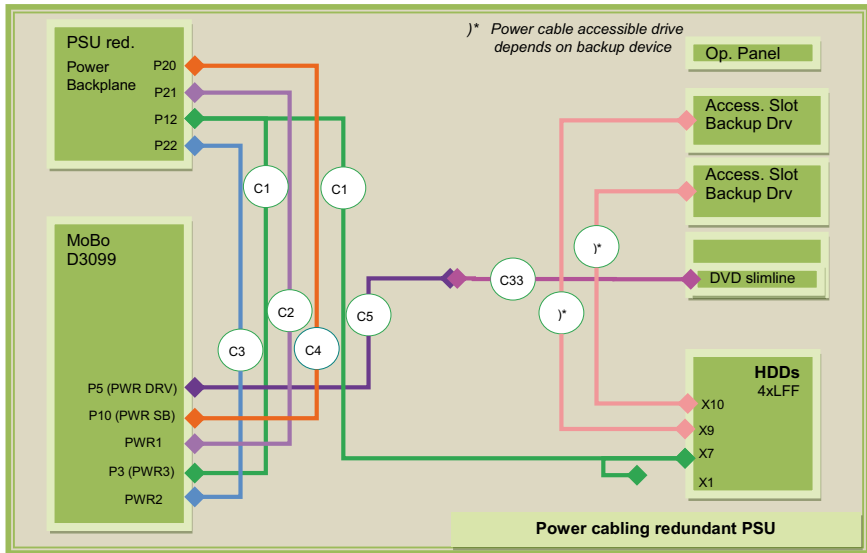

Figure 311: Cabling redundant PSU -TX200 S7

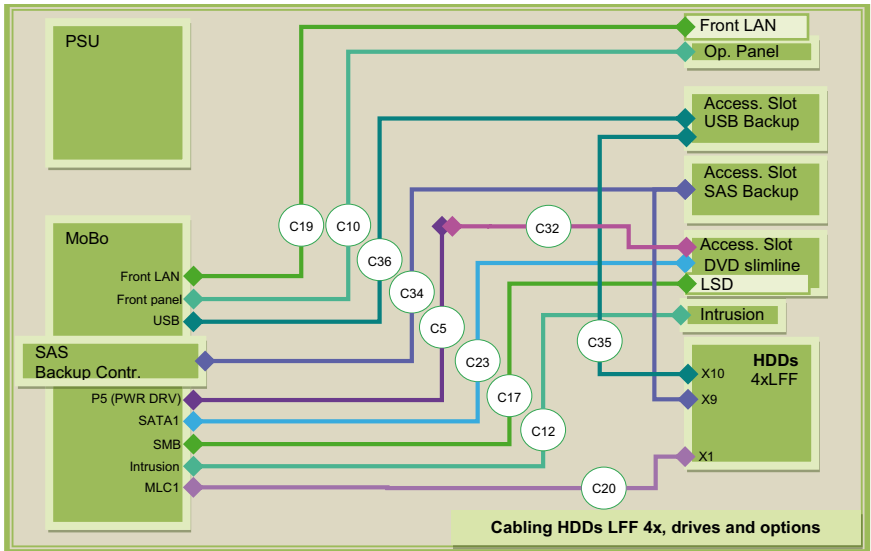

Figure 312: Cabling 3.5-inch HDDs and Multibay box

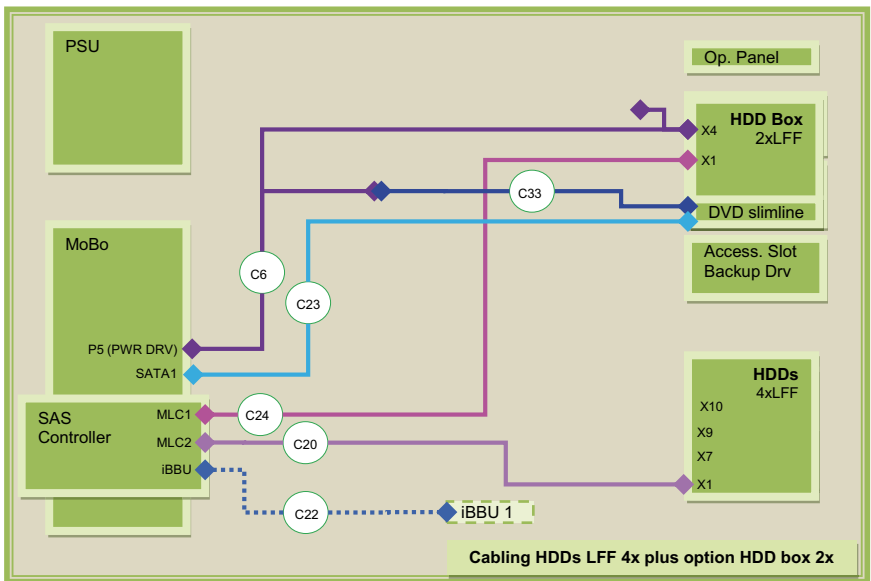

Figure 313: Cabling 3.5-inch HDDs and 2x 3.5-inch HDD extension box

Cabling

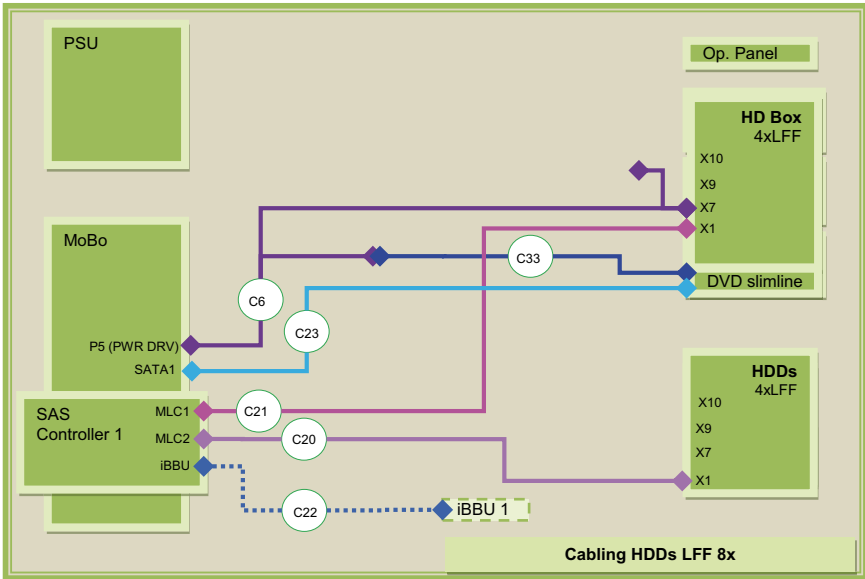

Figure 314: Cabling 3.5-inch HDDs and 4x 3.5-inch HDD extension box

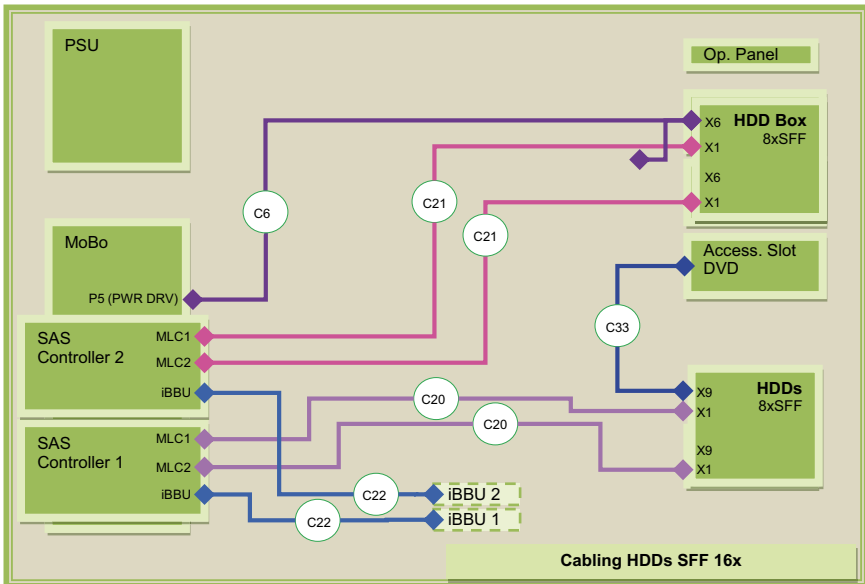

Figure 315: Cabling 2.5-inch HDDs and 8x 2.5-inch HDD extension box

16.3 Replacing the intrusion switch cable



Field Replaceable Unit
(FRU)



Hardware: 10 minutes

Tools: Phillips PH2 / (+) No. 2 screw driver

16.3.1 Preliminary steps

- ▶ "Locating the defective server" on page 47
- ▶ "Shutting down the server" on page 50
- ▶ "Disconnecting the server from the mains" on page 50
- ▶ "Getting access to the component" on page 51
- ▶ "Removing the system fan holder" on page 76

16.3.2 Removing the defective intrusion switch cable

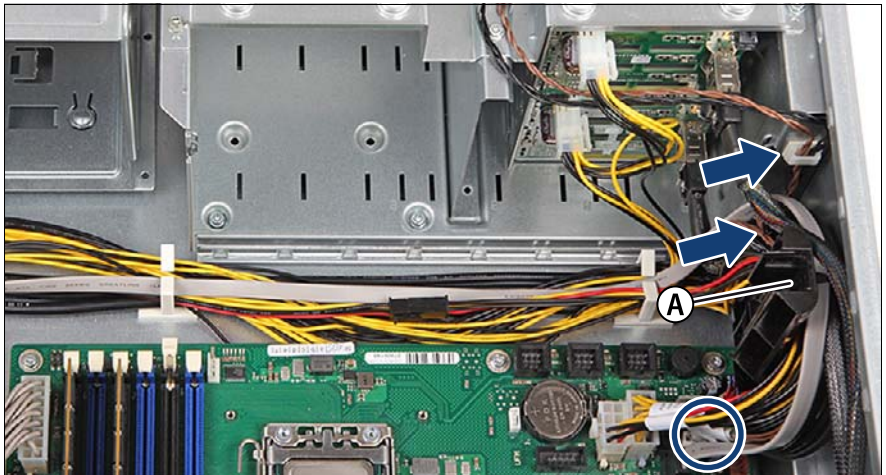

Figure 316: Disconnecting the intrusion switch cable

- ▶ Disconnect the intrusion switch cable from the system board (see circle).

Cabling

- ▶ Remove the intrusion switch cable from the cable guide (A) and the cable clamps (see arrows) on the HDD cage.

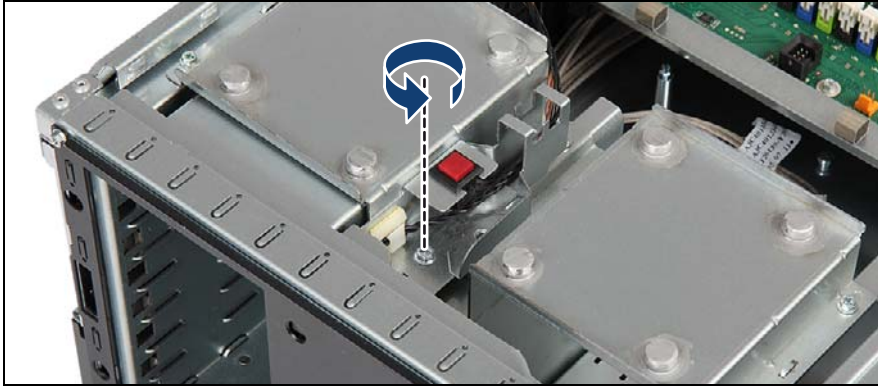

Figure 317: Removing the intrusion switch holder (A)

- ▶ Remove one screw from the intrusion switch holder as shown.

i Replacing the intrusion switch cable is illustrated by the example of the 2.5-inch HDD model. In case of the 3.5-inch HDD model, the procedure is identical, although the HDD bay top cover looks slightly different.

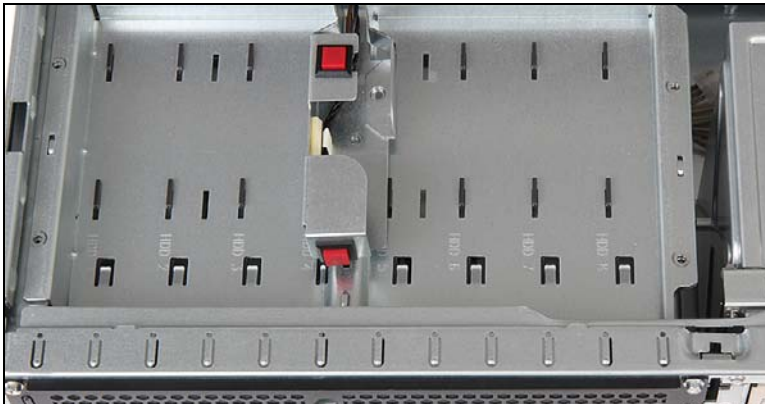

Figure 318: Intrusion switch holder in 3.5-inch HDD configurations

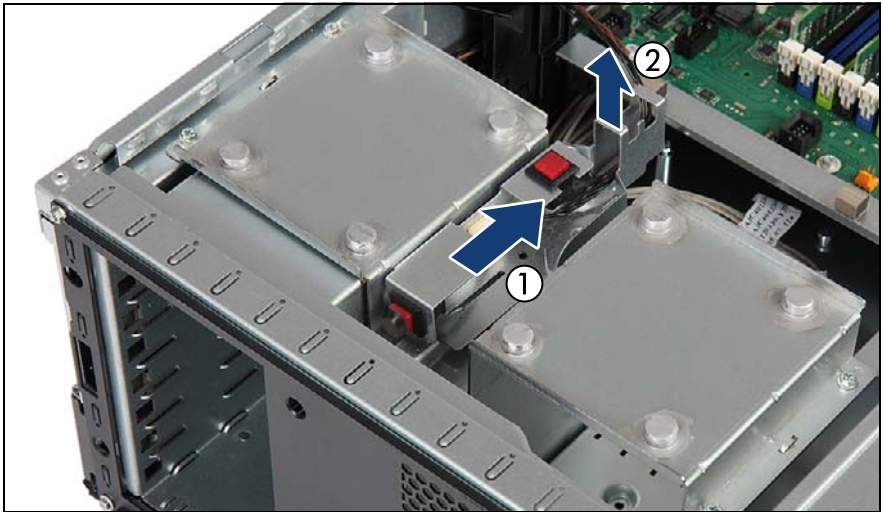

Figure 319: Removing the intrusion switch cable (B)

- ▶ Slide back the intrusion switch holder until it disengages from the HDD bay top cover (1).
- ▶ Remove the defective intrusion switch holder (2).

16.3.3 Installing the new intrusion switch cable

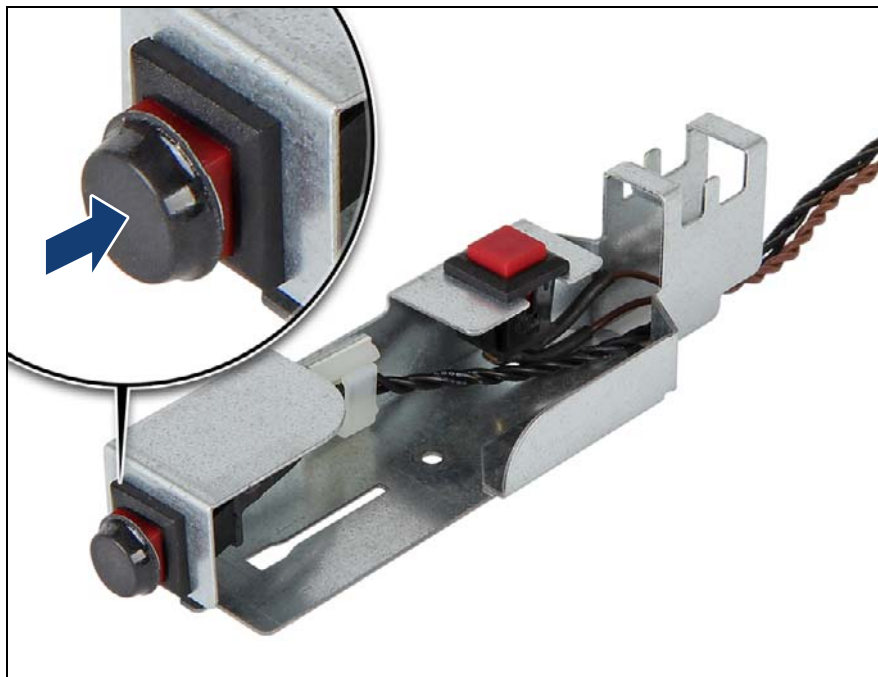

Figure 320: Attaching a rubber bumper to the front intrusion switch

- i** In case of rack server configurations, a rubber bumper needs to be attached to the front intrusion switch as described below. When working on a tower server, please skip this step.
- ▶ Attach a rubber bumper (C26192-Y26-C43) to the front intrusion switch as shown.

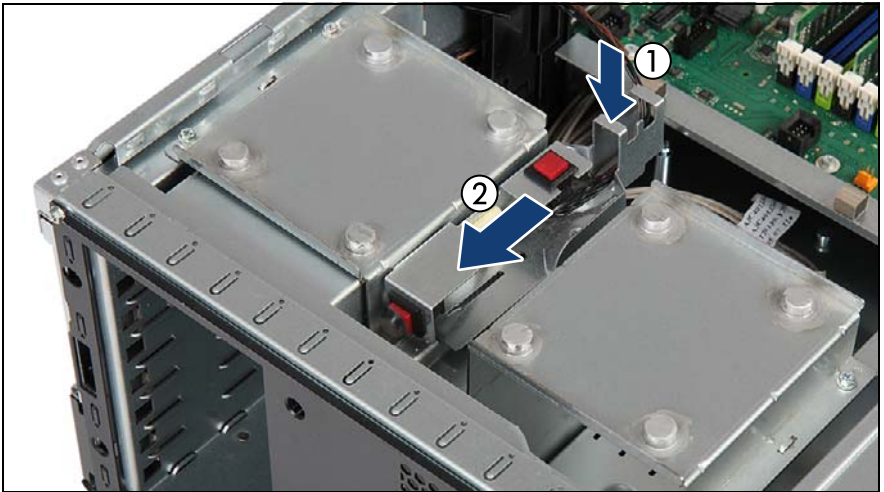

Figure 321: Installing the intrusion switch cable (A)

- ▶ Place the new intrusion switch holder on the HDD bay top cover as shown (1).
- ▶ Slide the intrusion switch holder under the front chassis rim as far as it will go (2).

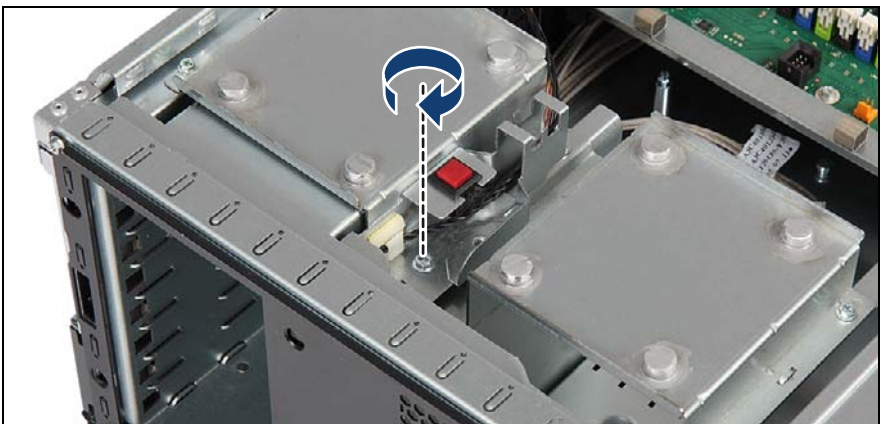

Figure 322: Installing the intrusion switch cable (B)

- ▶ Secure the intrusion switch holder on the HDD bay top cover with one screw.

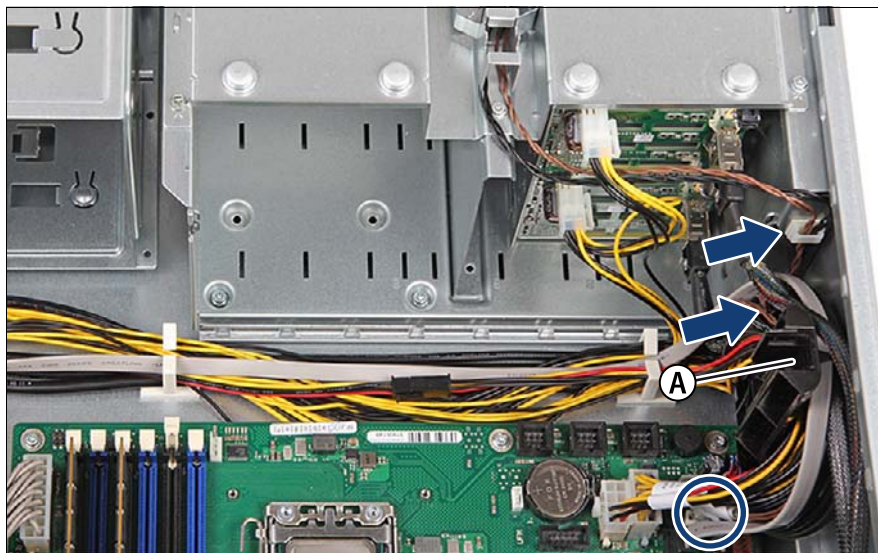

Figure 323: Connecting the intrusion switch cable

- ▶ Run the intrusion switch cable through the cable clamps (see arrows) on the HDD cage and the cable guide (A).
- ▶ Connect the intrusion switch cable to the system board connector "INTRUSION" (see circle).

16.3.4 Concluding steps

- ▶ ["Installing the system fan holder" on page 77](#)
- ▶ ["Reassembling" on page 64](#)
- ▶ ["Connecting the server to the mains" on page 74](#)
- ▶ ["Switching on the server" on page 75](#)

17 Appendix

17.1 Mechanical overview

17.1.1 Server front

2.5-inch HDD / SSD model

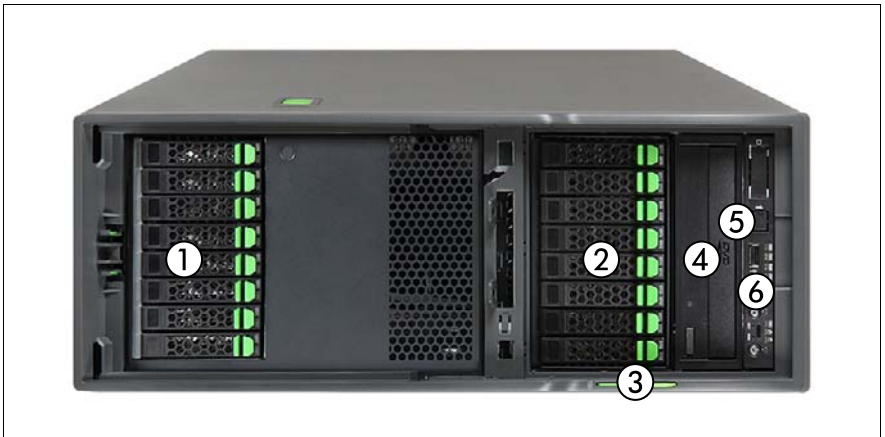

Figure 324: PRIMERGY TX200 S7 front - 2.5-inch HDD / SSD model

1	2.5-inch hard disk drives / solid state drives / dummy modules	4	Optical disk drive / 5.25-inch dummy module
2	8x 2.5-inch HDD extension box	5	Front panel module: Front Management LAN connector (optional)
3	ID card	6	Front panel module: 2 USB connectors

3.5-inch HDD model

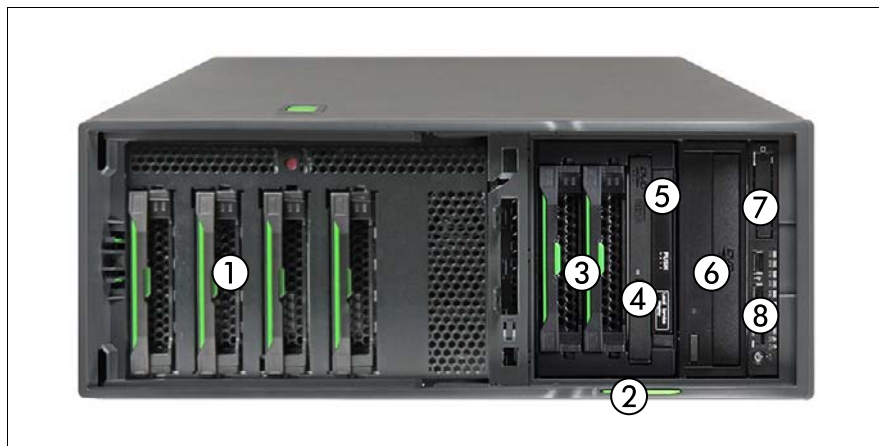

Figure 325: PRIMERGY TX200 S7 front - 3.5-inch HDD model

1	3.5-inch hard disk drives / dummy modules	5	Local service display module (LSD)
2	ID card	6	Backup drive / 5.25-inch dummy module
3	2x 3.5-inch HDD extension box with LSD and slimline ODD bays	7	Front panel module: Front Management LAN connector (optional)
4	Optical disk drive	8	Front panel module: 2 USB connectors

17.1.2 Server rear



Figure 326: Rear side

1	Power supply unit (photo shows the standard power supply unit)
2	I/O panel
3	Optional expansion cards

17.1.3 Server interior

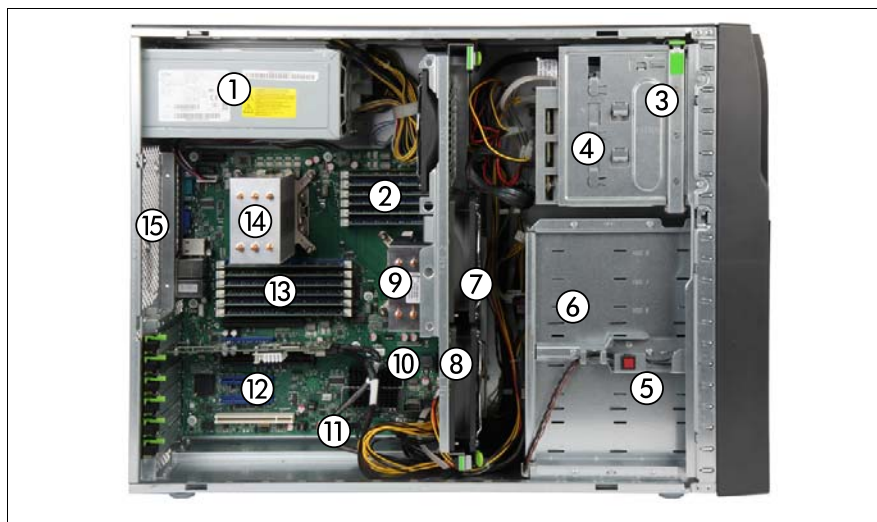

Figure 327: Interior (example: 2.5-inch HDD tower model)

1	Power supply unit (photo shows the standard power supply unit)
2	Memory modules (for CPU 1)
3	Front panel module bay
4	Accessible drive bay
5	Intrusion switches
6	HDD / SSD drive bays
7	System fans (fans 1-3)
8	CMOS battery (not visible, located under the system fan 1)
9	CPU 1 / CPU heat sink
10	UFM board (if installed)
11	TPM board (if installed)
12	Expansion card slots 1-6
13	Memory modules (for CPU 2)
14	CPU 2 / CPU heat sink
15	Optional system redundant fan (if installed)

17.2 Connectors and indicators

17.2.1 Connectors and indicators on the system board

17.2.1.1 Onboard connectors

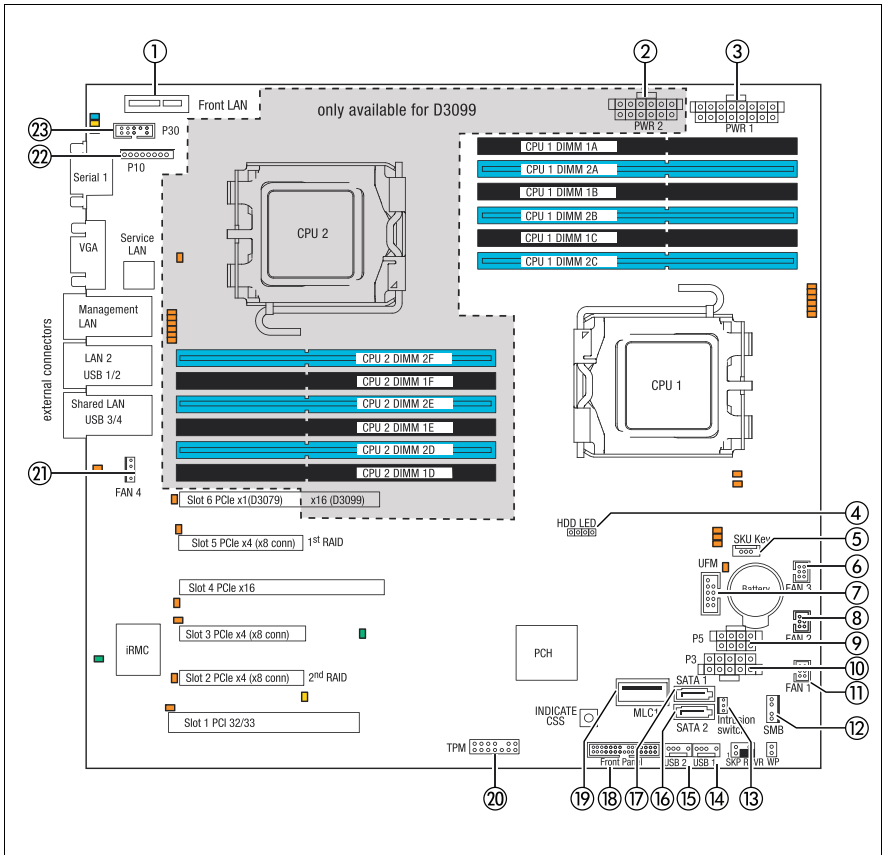

Figure 328: Internal connectors of system board D3079 (TX150 S8) / D3099 (TX200 S7)

Appendix

1	Front LAN	Slot for front LAN connector board
2	PWR 2	System power connector 2
3	PWR 1	System power connector 1
4	HDD LED	HDD activity (internal)
5	SKU Key	Connector for SCU (SKU) key
6	FAN 3	Connector for system fan 3
7	UFM	Connector for USB Flash Module (UFM)
8	FAN 2	Connector for system fan 2
9	P5 (PWR DRV)	ODD power connector
10	P3 (PWR 3)	Main power connector
11	FAN 1	Connector for system fan 1
12	SMB	Connector for Local Service Display (LSD)
13	Intrusion switch	Intrusion switch cable connector
14	USB INT 1	USB connectors for USB backup drives
15	USB INT 2	
16	SATA 2	SATA connector for accessible SATA drives
17	SATA 1	SATA connector for accessible SATA drives
18	Front panel	Connector for front panel and front USB connectors
19	MLC1	SATA connector
20	TPM	Connector for Trusted Platform Module (TPM)
21	FAN 4	Connector for system redundant fan (optional)
22	P10	PC2009 connector
23	P30 (PWR SB)	Connector for sideband power backplane

17.2.1.2 Onboard indicators and controls

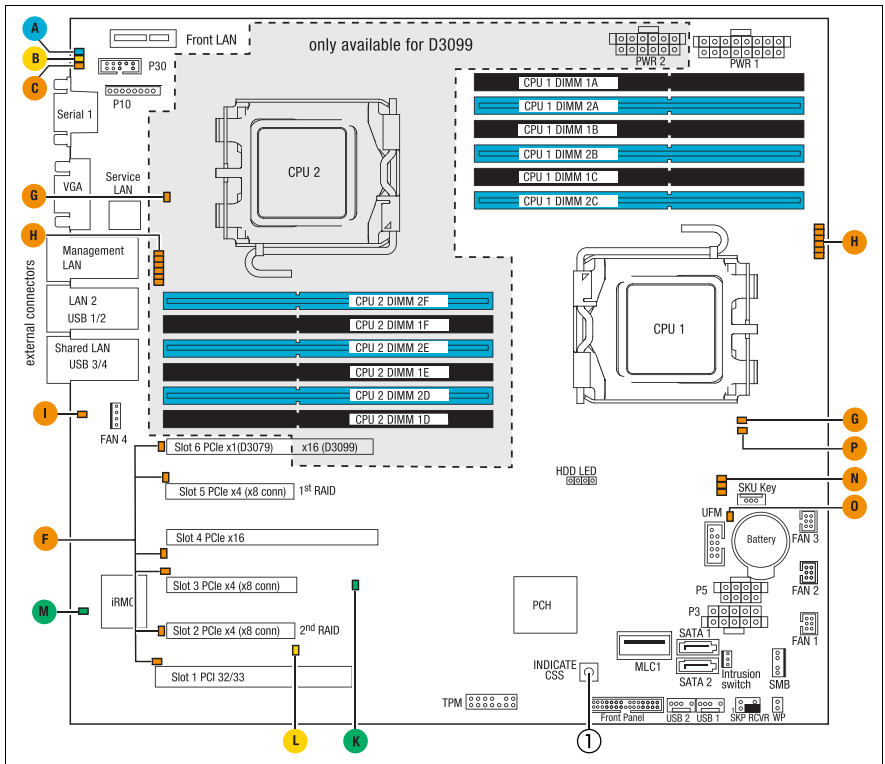

Figure 329: Onboard indicators and Indicate CSS button

1	Indicate CSS button
---	---------------------

Component LEDs

i LEDs A, B and C are visible from the outside on the server rear. All other LEDs are only visible if the server cover has been opened.

Indicator	Status	Description
A ID indicator	blue on	server has been highlighted using ServerView Operations Manager or the ID button on the front panel for easy identification

Appendix

Indicator		Status	Description
B	CSS (Customer Self Service)	off	no critical event (CSS component)
		yellow on	prefailure detected (CSS component)
		yellow flashing	CSS component failure
C	GEL (Global Error LED)	off	no critical event (non CSS component)
		orange on	prefailure detected (non CSS component)
		orange flashing	non CSS component failure Possible reasons: <ul style="list-style-type: none"> – sensors report overheating – sensor is defective – CPU error – software reports an error
D	LAN link/transfer	green on	LAN link
		green flashing	LAN transfer
		off	No LAN link
E	LAN speed	off	10 Mbit/s
		green on	100 Mbit/s
		yellow on	1000 Mbit/s
F	Controller	off	PCI card okay
		orange on	PCI card failure
G	CPU	off	CPU okay
		orange on	CPU failure
H	Memory module	off	memory module running
		orange on	memory module failure
I	Fan 4	off	system redundant fan running
		orange on	system redundant fan failure
K	Main power	green on	main voltages are within range
L	Standby power	yellow on	standby voltages are within range
M	iRMC	off	iRMC S3 is inactive
		green flashing	iRMC S3 okay

Indicator	Status	Description	
N	Fans	off	fan running
		orange on	fan failure
O	Battery	off	battery running
		orange on	battery failure
P	Memory module	orange on	at least one memory module faulty

17.2.1.3 I/O panel connectors

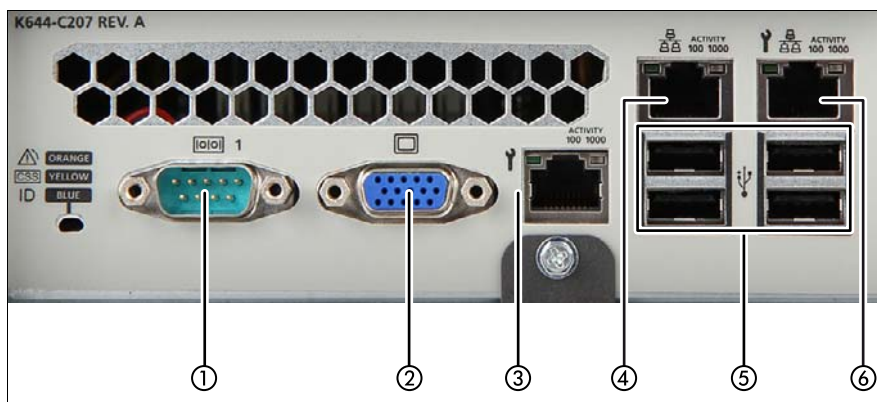

Figure 330: I/O panel connectors

1	Serial connector COM1
2	Video connector (VGA)
3	Management LAN connector
4	Standard LAN connector
5	4 USB connectors
6	Shared LAN connector

Depending on BIOS settings, the shared LAN connector may also be used as a management LAN connector. For further information, please refer to the corresponding BIOS Setup Utility reference manual.

Appendix

The serial connector COM1 can be used as default interface or to communicate with the iRMC S3.

i The chipset offers two integrated USB 2.0 Rate Matching Hubs (RMHs) that enable lower power requirements and manages the transition of the communication data rate from the high speed of the host controller to the lower speed of USB full speed / low speed devices.

17.2.1.4 I/O panel indicators

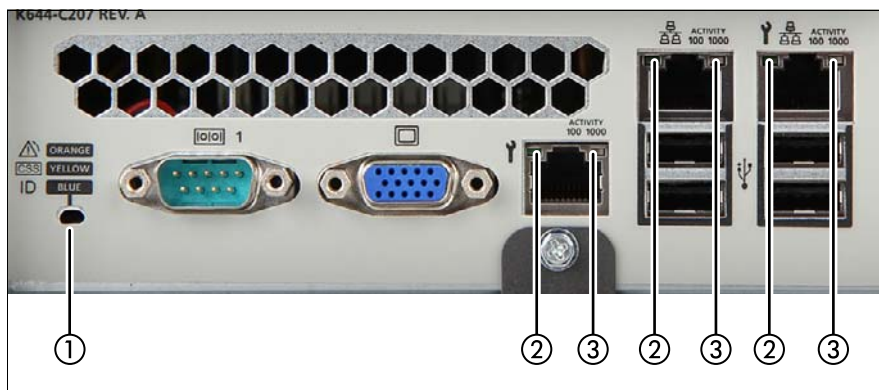

Figure 331: I/O panel indicators

Indicator	Status	Description	
1	Global error indicator	off	no critical event (non-CSS component)
		orange on	prefailure detected (non-CSS component)
		orange flashing	non CSS component failure
1	CSS indicator	off	no critical event (CSS component)
		yellow on	prefailure detected (CSS component)
		yellow flashing	CSS component failure
1	ID indicator	blue on	server has been highlighted using ServerView Operations Manager or the ID button on the front panel for easy identification

Indicator		Status	Description
2	LAN link / transfer indicator	green on	LAN connection established
		off	no LAN connection
		green flashing	data transfer in progress
3	LAN speed indicator	yellow on	traffic a transfer rate of 1 Gbit/s
		green on	traffic a transfer rate of 100 Mbit/s
		off	traffic a transfer rate of 10 Mbit/s



Note on the onboard LAN controller

The separate management LAN connector is used as a management interface (iRMC S3) and is prepared for operation with the Remote Management. Optionally LAN connector 1 can also be used for iRMC S3 server management.

17.2.1.5 PSU indicator (only hot-plug PSUs)

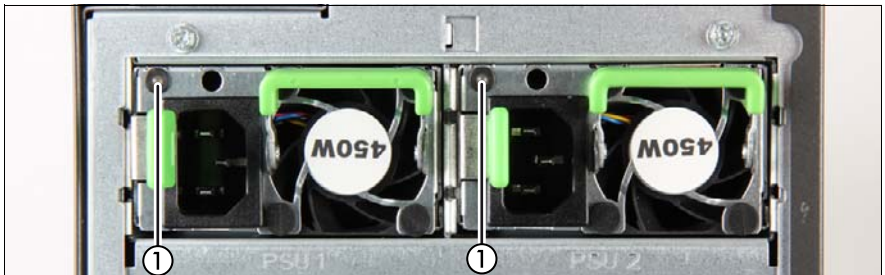

Figure 332: PSU indicator

Indicator		Status	Description
1	PSU operating status	green on	Server is switched on and functioning properly
		green flashing	Server is switched off, main voltage is present (Standby mode)
		orange on	PSU failure (over / under voltage, over temperature or fan failure)
		orange flashing	Overload warning

17.2.2 Connectors and indicators on the front panel

17.2.2.1 Front panel connectors

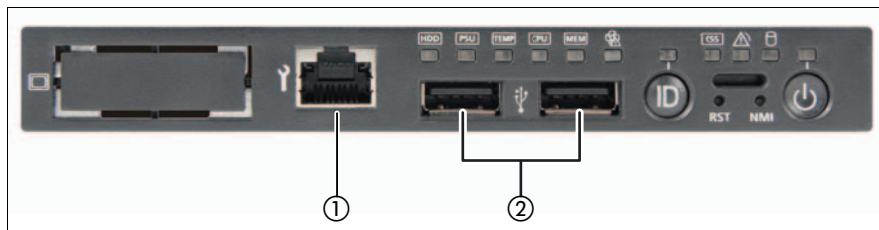

Figure 333: Front panel connectors

Pos.	Component
1	Front LAN connector (optional)
2	2 USB connectors

17.2.2.2 Front panel controls and indicators

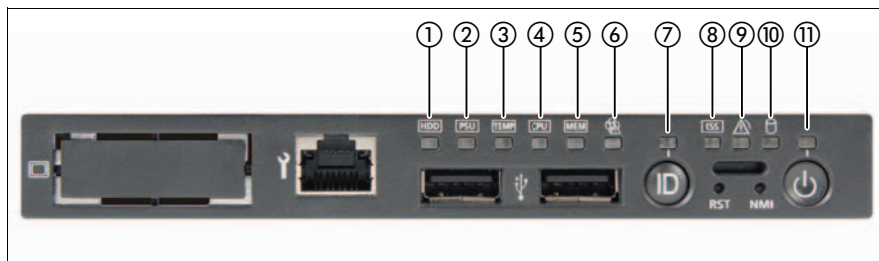

Figure 334: Front panel controls and indicators

Local diagnostic indicators

Pos.	Indicator	Status	Description
1	HDD / SSD error indicator	orange on	HDD / SSD, SAS / SATA backplane or RAID controller failure detected
2	PSU error indicator	orange on	Hot-plug PSU failure detected <div style="display: flex; align-items: center;"> <div style="border: 1px solid black; padding: 2px; margin-right: 5px;">i</div> Only available in redundant PSU configurations. </div>

Pos.	Indicator	Status	Description
3	Temperature error indicator	orange on	Operating temperature levels above permitted limits
4	CPU error indicator	orange on	CPU prefailure event detected
5	Memory error indicator	orange on	Memory module failure detected
6	Fan error indicator	orange on	Fan prefailure or failure event detected

i In addition to local diagnostic indicators, CSS or Global Error LEDs indicate, if the defective component is a customer replaceable unit or if a service technician needs to be dispatched to replace the part.

Status indicators

Pos.	Indicator	Status	Description
7	ID indicator	blue on	server has been highlighted using ServerView Operations Manager or the ID button on the front panel for easy identification
8	CSS indicator	off	no critical event (CSS component)
		yellow on	prefailure detected (CSS component)
		yellow flashing	CSS component failure
9	Global error indicator	off	no critical event (non CSS component)
		orange on	prefailure detected (non CSS component)
		orange flashing	non CSS component failure
10	HDD / SSD activity indicator	green flashing	data access in progress

Appendix

Pos.	Indicator	Status	Description
11	Power-on indicator	green on	server is switched on and running
		orange on	server is switched off, but mains voltage is present (standby mode)



The meaning of further buttons is described in the corresponding operating manual.

17.3 Onboard settings

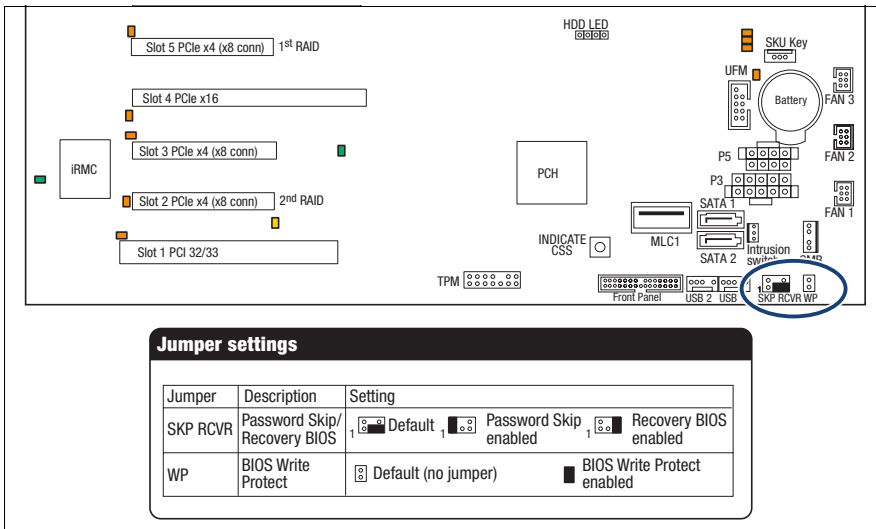

Figure 335: Onboard settings

Jumper	Setting	Description
SKP RCVR	Default	Password delete and Recovery BIOS options disabled
	Password Skip enabled	This jumper setting will permanently delete the current BIOS password and apply default BIOS settings.
	Recovery BIOS enabled	Recovery BIOS enabled

Jumper	Setting	Description
WP	Default (no jumper)	BIOS Write Protect disabled
	BIOS Write Protect enabled	BIOS Write Protect enabled

17.4 Minimum startup configuration



Field Replaceable Units (FRU)

If the server does not start up or other problems occur, it may be necessary to take the system down to its most basic configuration in order to isolate the defective component.

The minimum startup configuration consists of the following components and cables:

Component	Notes and reference
System board	no TPM, UFM or expansion cards installed
1 CPU with CPU heat sink	installed in socket CPU 1
1 memory module	installed in DIMM slot 1A
Front panel module	without connected front LAN module
1 Power supply module	installed in PSU bay 1

Table 6: Minimum startup configuration - components

Cable	Notes and reference
Front panel cable	
Power cable	

Table 7: Minimum startup configuration - cables

- ▶ ["Shutting down the server" on page 50](#)
- ▶ ["Disconnecting the server from the mains" on page 50](#)

- ▶ Take the system down to its minimum startup configuration.
- ▶ ["Connecting the server to the mains" on page 74](#)
- ▶ Connect a keyboard, mouse and display to the server.
- ▶ Switch on the server as described in section ["Switching on the server" on page 75](#).



CAUTION!

Since the fan module is not included in the minimum startup configuration, the server must be shut down immediately after the diagnostic process is complete (POST phase has been passed).

The minimum startup configuration must be used exclusively for diagnostic purposes by maintenance personnel, never in daily operation!