



# Rack Solutions for Any IT Environment

Enclosure, Rack Systems, and Accessories



[apc.com](http://apc.com)

Life Is On



# Table of Contents

APC Connected Products	3
NetShelter Enclosures & Rack Systems Applications and Selection	4
NetShelter SX Enclosures	5
NetShelter CX Enclosures	14
NetShelter Wall-mount Enclosures	16
Open Frame Racks	18
NetShelter Custom and Specialty Enclosures	20
Introducing APC Easy Racks	22
Easy Rack Selection	24
Rack Cooling and Airflow Management	25
Rack Power Distribution	27
Easy Rack PDUs	28
NetBotz Security and Monitoring	30
LCD Monitors and KVM Switches	31
NetShelter Cable Management	32
Shelves and Mounting Hardware	34
NetShelter Enclosures with Shock Packaging & Shock Pallet	35
EcoStruxure™ Data Center Solutions	38
Explore, Select, and Configure	39



# APC Connected Products

APC™ delivers Certainty in a Connected World with offers that help home and business provide reliable and efficient power solutions for IT and communications technologies.

## NetShelter Master Range

Standard and custom racks for IT equipment in any environment



APC NetShelter™ rack systems offer standard and custom full, half, and wall rack enclosures designed to house critical IT infrastructure in IT, commercial, and industrial environments. NetShelter rack systems are built to last, highly secure, and simple to configure.

## NetShelter Racks & Enclosures

Network and server rack enclosures

Open and enclosed server rack and network rack solutions for a variety of environments including data centers, server rooms, network closets, offices, industrial, and specialty applications.



## NetShelter Rack Power Distribution

Basic and intelligent Rack PDUs

Rack PDUs provide server-level power availability with a variety of power metering and control options as well as environmental monitoring capability.



## NetBotz Security & Environmental Monitoring

Security & Environmental appliances and sensors/cameras/accessories

NetBotz™ consists of rack mount and wall mount appliances designed to provide a wide range of integrated environmental monitoring and surveillance for sensitive equipment.



## NetShelter Server Access

KVMs, rack LCD consoles, and switches

Manage multiple servers from a single location with rack LCD consoles, KVM switches, and Ethernet switches.



## NetShelter Data Center Containment

Managing airflow for rows, racks and hot spots

Data Center Containment solutions are designed to increase cooling system efficiency while protecting critical IT equipment and personnel.

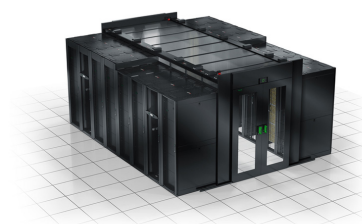



# NetShelter Enclosures & Rack Systems Applications and Selection

Today's wide range of IT applications and environments demand a variety of rack infrastructures that can mount a mix of different equipment and efficiently manage, monitor, and control IT anywhere in an enterprise.

## Racks and enclosures: the building blocks of every IT environment

Trends like edge computing, virtualization, consolidation, convergence, and blade server adoption are forcing different types of equipment to share the same space and in varying environments whether inside or outside the data center space. Edge deployments let organizations leverage the benefits of the Internet of Things by placing compute power and analysis closer to the action.

Whether it's an industrial warehouse, network closet, server room, or data center of any size, IT operations rely on racks and enclosures for support, organization, and management of rack-mount equipment. Servers, storage, switches, routers, PDUs, console port servers, KVM switches - Today's racks and enclosures are expected to exist in more environments and support a greater number and variety of applications and devices (em dash) servers, storage, switches, routers, PDUs, console port servers, and KVM switches.

## Rack solutions for any IT environment

Discover > Office  
View NetShelter CX

Discover > Remote location  
View NetShelter Wall-mount

Discover > Remote edge  
View EcoStruxure Data Center Solutions

Discover > Network closet  
View Open Frame Racks

Discover > Server room  
View NetShelter SX

Discover > Data center  
View NetShelter SX

Still not sure?  
Help me choose  
on SE.com.

Visit now >



# NetShelter SX Enclosures

## The world's most versatile rack enclosure for demanding IT environments

Ready for high-density and edge environments right out of the box, NetShelter SX rack enclosures offer the most standard features on the market today. Influenced by over 15 years of customer feedback and over 1 million units sold, Schneider Electric has specifically engineered the next-generation NetShelter SX enclosure to handle a broad range of applications from power-hungry, high-density server and networking applications to remote edge computing applications.

The NetShelter SX is the base building block of the EcoStruxure™ Data Center Solutions. NetShelter SX has many inherent features that facilitate a faster installation and reduce handling after installation, lowering your installation and operating costs. In addition, the homogenous appearance of the NetShelter SX and its sister components in an EcoStruxure solution provides a clean, consistent look that first-rate data centers require.

## Edge computing applications

Edge deployments let organizations leverage the benefits of IoT by placing compute power and analysis closer to the action. Whether you're running a network of retail stores, a group of geographically dispersed factories, or a remote oil pipeline, edge computing enables real-time decision-making whereas in cloud environments, data experiences latency as it travels hundreds or thousands of miles to data centers. An edge environment eliminates latency issues.

## Rack enclosure systems for converged IT

With IT hardware trending toward converged infrastructure (CI) and single-source IT providers, a simplified prebuilt and pretested solution is in demand. Customers are looking for solutions that deliver fully populated IT racks — whether to the customer site or a colocation facility.

Schneider Electric rack systems are optimized for this situation. Special packaging options for NetShelter SX enable integrators to “rack and stack” the solution for a truly end-to-end converged system delivered prebuilt, pretested, racked, and shipped to the end customer.



## Features

### Best-in-class design

- Offers most standard features to facilitate installation and speed of deployment.
- Integrates seamlessly with the full line of EcoStruxure components.

### Greatest flexibility

- Available in a wide range of heights, widths, and depths to meet a variety of data center and edge computing applications.
- Rapid installation of vertical rack PDUs in the rear vertical zero-U accessory channel of NetShelter enclosures.

### Superior cable management capabilities

- Accommodates high-density networking and blade applications.
- Easy installation to enable faster and easier moves, adds, and changes.
- Promotes proper airflow to improve cooling efficiency.

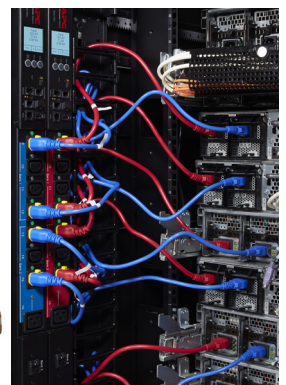

# NetShelter SX Enclosure Features

## More standard features for faster installation

### 1 Cable access roof

- Eight cable entry slots
- Toolless mounting of overhead cable trough system
- Snap-in mounting to allow easy roof removal and installation with cables in place

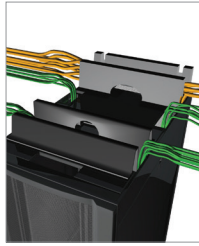

### 2 Integrated baying brackets

- Preinstalled on frame, front and back
- Spacing options at 24 in. (600 mm)
- Bays with other Schneider Electric power and cooling products

### 3 Preinstalled leveling feet and casters

- Easily adjustable leveling from top-down
- Casters standard on all enclosures

### 4 Toolless, zero-U accessory channel

- Toollessly mount rack PDUs
- Toollessly mount vertical cable organizers



### 5 Easily adjustable vertical mounting rails

- Simple screw and cam engagement
- Captive screws — no loose hardware
- Easy visual alignment for quick adjustment
- Adjust in 0.25 in. (6 mm) increments through enclosure
- Hole cutouts for 0U installation (AR8469) of Data Distribution Cable (DDC) accessories

### 6 Half-height side panels

- Easy and safe handling
- Quick release latch
- Lockable — same key as doors
- Enclosure width remains the same with or without sides attached



### Other standard features include:

- Integrated electrical bonding of sides, doors, roof, and rails to frame
- Ventilated front and rear doors
- Split-rear ventilated rear doors for better clearance in hot aisle
- Numbered U positions front and back
- Open bottom for unobstructed under-floor access
- 1700 kg (3,750 lb) static load, 1020 kg (2,250 lb) dynamic (rolling) load\*
- UL Listed
- Electronic Industries Association (EIA)/ECA-310-E compliant
- Meets IBC® seismic requirements with proper bolt-down hardware

\*Excluding 12, 18, and 24U heights

Available as a complete Micro Data Center with integrated power.

[Discover more >](#)

Take the NetShelter SX 3D tour.

[Discover more >](#)

# NetShelter SX Enclosures Selection

## Applications for height

- 12, 18, and 24U enclosures — Remote offices and small spaces.
- 42U enclosures — Standard height used globally, designed to fit through standard doorways.
- 45U enclosures — Enclosures with additional U-spaces for environments that standardize on a 45U, 7 ft. (213 cm) enclosure height.
- 48, and 52U enclosures — More U-spaces for more equipment in the same footprint.

## Applications for width

- 24 in. (600 mm) wide enclosures are the standard for most server applications. For higher densities, a deeper enclosure may be required.
- 30 in. (750 mm) wide enclosures offer more space for high-capacity cable management and power distribution. Typically, wider enclosures are used for networking applications but the extra side space is often requested in blade server applications.

## Applications for depth

- 32.5 in. (825 mm) is the preferred depth for AV equipment. 42 in. (1070 mm) is the standard depth and meets most low- to medium-density applications.
- 48 in. (1200 mm) deep enclosures are becoming the new standard because of increasing server depth crowding cable and power space.



NetShelter SKU	Height	Width	Depth	Application
AR3003 <sup>1</sup>	12U	600 mm (24 in.)	889 mm (35 in.)	Remote server applications
AR3006 <sup>1</sup>	18U	600 mm (24 in.)	889 mm (35 in.)	Remote server applications
AR3103 <sup>1</sup>	12U	600 mm (24 in.)	1070 mm (42 in.)	Remote server applications
AR3106 <sup>1</sup>	18U	600 mm (24 in.)	1070 mm (42 in.)	Remote server applications
AR3104	24U	600 mm (24 in.)	1070 mm (42 in.)	Remote server applications
AR3100 <sup>1 2 3 4</sup>	42U	600 mm (24 in.)	1070 mm (42 in.)	Low/medium-density servers
AR3105 <sup>2 3 4</sup>	45U	600 mm (24 in.)	1070 mm (42 in.)	Low/medium-density servers
AR3107 <sup>1 2 3</sup>	48U	600 mm (24 in.)	1070 mm (42 in.)	Low/medium-density servers
AR3150 <sup>1 2 3</sup>	42U	750 mm (30 in.)	1070 mm (42 in.)	Networking and blade applications
AR3155 <sup>2 3</sup>	45U	750 mm (30 in.)	1070 mm (42 in.)	Networking and blade applications
AR3157 <sup>1 2</sup>	48U	750 mm (30 in.)	1070 mm (42 in.)	Networking and blade applications
AR3300 <sup>1 2 3</sup>	42U	600 mm (24 in.)	1200 mm (48 in.)	Medium/high-density servers
AR9300SP / AR9300SP-R <sup>1</sup>	42U	600 mm (24 in.)	1200 mm (48 in.)	Heavy IT applications
AR3305 <sup>2 3</sup>	45U	600 mm (24 in.)	1200 mm (48 in.)	Medium/high-density servers
AR3307 <sup>1 2 3</sup>	48U	600 mm (24 in.)	1200 mm (48 in.)	Medium/high-density servers
AR3350 <sup>1 2 3</sup>	42U	750 mm (30 in.)	1200 mm (48 in.)	HD networking and blade applications
AR9307SP / AR9307SP-R <sup>1</sup>	42U	600 mm (24 in.)	1200 mm (48 in.)	Heavy IT applications
AR3355 <sup>2 3</sup>	45U	750 mm (30 in.)	1200 mm (48 in.)	HD networking and blade applications
AR3357 <sup>1 2</sup>	48U	750 mm (30 in.)	1200 mm (48 in.)	Networking and blade applications
AR3307X674	52U	600 mm (24 in.)	1200 mm (48 in.)	HD networking and blade applications
AR3357X674	52U	750 mm (30 in.)	1200 mm (48 in.)	HD networking and blade applications
AR3140 <sup>3</sup>	42U	750 mm (30 in.)	1070 mm (42 in.)	High-density networking
AR3340 <sup>1</sup>	42U	750 mm (30 in.)	1200 mm (48 in.)	Very high-density networking
AR3347	48U	750 mm (30 in.)	1200 mm (48 in.)	Very high-density networking
AR3200	42U	600 mm (24 in.)	1070 mm (42 in.)	2 x 20U compartments for colocation
AR3810	42U	600 mm (24 in.)	825 mm (32.5 in.)	Audiovisual applications
AR3812	42U	600 mm (24 in.)	825 mm (32.5 in.)	Audiovisual applications
AR3814	24U	600 mm (24 in.)	825 mm (32.5 in.)	Audiovisual applications

<sup>1</sup> The following can be preconfigured without standard doors and side panels. Reference part numbers AR3\_\_\_X609 for no sides, AR3\_\_\_X610 for no doors, and AR3\_\_\_X617 for no sides/no doors. More configurations are available; contact your local APC sales representative for more information.

<sup>2</sup> TAA compliant enclosure available.

<sup>3</sup> White enclosure available.

<sup>4</sup> Shock packaging available for shipping enclosures with equipment installed. Check [apc.com](http://apc.com) for allowable equipment weight amounts.



# NetShelter SX Networking Enclosures

Optimized NetShelter SX design for enhanced networking application support and a superior solution for side airflow networking switches

## 1 Cable access roof

- Extra-large cable access slots for high-density cabling and brush strips for air containment
- Two spring-loaded pins allow for easy roof removal and installation with cables in place



## 2 Networking-style mounting rails

- Easily align rails that adjust in 0.25 in. (6mm) increments
- Left vertical mounting rail contains additional cable channel
- Rail position preset to accommodate Cisco switches and cable management

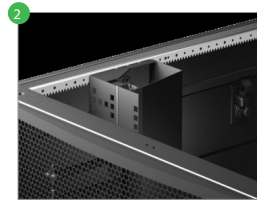

## 3 Preinstalled vertical cable managers

- Front vertical mounting rails feature preinstalled, single-sided vertical cable managers
- Smooth plastic fingers provide proper bend radius for cables

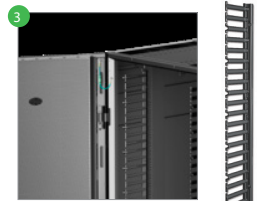

## 4 Vertical mounting rails for side-to-side airflow

- Front-right vertical mounting rail open for improved side airflow



AR3340 with AR7725 duct kits for Cisco Nexus 7009  
AR3140\* — 42U x 30 in. (750mm) W x 42 in. (1070mm) D  
AR3340\* — 42U x 30 in. (750mm) W x 48 in. (1200mm) D  
AR3347 — 48U x 30 in. (750mm) W x 48 in. (1200mm) D

\*For white version add W to part number

## Side airflow cooling

- Support cooling for small and large networking switches mounted within an enclosure.
- Side airflow solution (AR7742/AR7747) for Cisco® Nexus 7018

## All solutions

- Direct cool air at the front of the enclosure directly and predictably to the intake at the side-of-side airflow switches
- Consist of two duct assemblies that act as diverters using the existing fan power of the switch
- Contain a system of baffles located throughout the enclosure to mitigate exhaust air from recirculating back into the air intake



AR3340 networking enclosure and AR7742 side airflow solution for Cisco Nexus 7018

# NetShelter High Strength Enclosures

The NetShelter SX3K is designed to handle the heaviest of IT loads – converged, hyperconverged, hyperscale, and data storage.

Includes a cabinet and shipping solution that allows complete integration and shipping of costly IT systems to your site or a colocation site for immediate plug-and-play with no added installation, setup, or downtime.

## Industry leading dynamic shipping rating

- Load, transport, unload, and deploy a cabinet with up to 3,500 lb. (1,587 kg) of IT equipment installed.
- The cabinet is rated to 3,500 lb. (1,587 kg) dynamic (rolling) and shipping and 4,250 lb. (1,927 kg) static (levelling) feet.
- The solution has been tested to industry standard International Safe Transit Association™ 3E transportation and shipping testing.

## Strengthening the base building block of EcoStruxure

- The NetShelter SX3K has been designed to seamlessly integrate into Schneider Electric’s EcoStruxure modular, scalable, data center infrastructure.
- Available in 42U and 48U heights and compatible with hundreds of APC accessories.

## Features

- Hassle-free installation, integration, configuration – Easy-to-remove/reassemble shock packaging
- Added load support – Robust equipment fastening system, vertical/horizontal stiffeners, and heavy-duty EIA (electronics industry alliance) equipment mounting rails
- Smooth maneuverability – Durable, heavy-duty casters
- Complete rack stability – Cabinet elevation/pallet brackets
- Simplified cabinet removal – Metal reusable ramp (sold separately), built-in rails, and fixed rear casters
- Outer protection – Complete outer wrap and protective inserts
- Shock pallet – Impact- and vibration-resistance during integration/transport



Note: AR9000RAMP sold separately

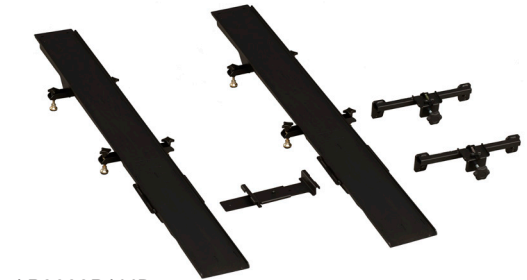

AR9000RAMP

NetShelter SKU	U-space	Height	Width	Depth	Max mounting depth	Shipping Load Capacity	Packaged
AR9300SP	42U	1991 mm (78.4 in.)	600 mm (24 in.)	1200 mm (48 in.)	1048 mm (41.3 in.)	1587 kg (3500 lb.)	Shock pallet and packaging
AR9300SP-R	42U	1991 mm (78.4 in.)	600 mm (24 in.)	1200 mm (48 in.)	1048 mm (41.3 in.)	1587 kg (3500 lb.)	Shock pallet, packaging, and reusable ramp
AR9307SP	48U	2258 mm (88.9 in.)	600 mm (24 in.)	1200 mm (48 in.)	1048 mm (41.3 in.)	1587 kg (3500 lb.)	Shock pallet and packaging
AR9307SP-R	48U	2258 mm (88.9 in.)	600 mm (24 in.)	1200 mm (48 in.)	1048 mm (41.3 in.)	1587 kg (3500 lb.)	Shock pallet, packaging, and reusable ramp

# NetShelter SX Cable Management

## Server and networking applications

As the number of IT components within each rack enclosure continues to increase, so do the number of power and data cables. APC offers a large selection of vertical and horizontal cable managers to address today's cable routing demands. From toolless-install ring-style managers for server applications, to high-density finger-type managers for supporting patching and switches, APC is a leader in innovative, application-driven solutions. Our unique overhead cable management system turns the top of the enclosure into a cable tray, eliminating the need to use space under a raised floor and permitting better organization in nonraised floor environments.

APC has a strong history supporting the server applications in data centers around the world. The innovative, toolless, snap-in accessories have become the benchmark for server cable management.



Check out “Cable Management for Enclosure and Rack Systems” for a comprehensive list of cable management options.

[Discover more >](#)



## High-capacity cable managers can be used to support fiber and copper cable bundles

- 1 **AR7580A** — High-capacity vertical cable manager for NetShelter SX 30 in. wide enclosures (AR3x5x), supports 190 to 250 CAT 6A/CAT 6 data cables per section and 190 CAT 6A per channel section. Each kit covers one corner of the enclosure.
- 2 **AR7581A** — Hinged covers for AR7580A vertical cable managers.
- 3 Fiber slack spools for mounting to the vertical mounting rails of NetShelter SX 30 in. wide enclosures (AR3x5x).

Additional high-capacity vertical cable managers and covers available for specific enclosure heights, 42, 45, and 48U. Visit the website for a complete listing.

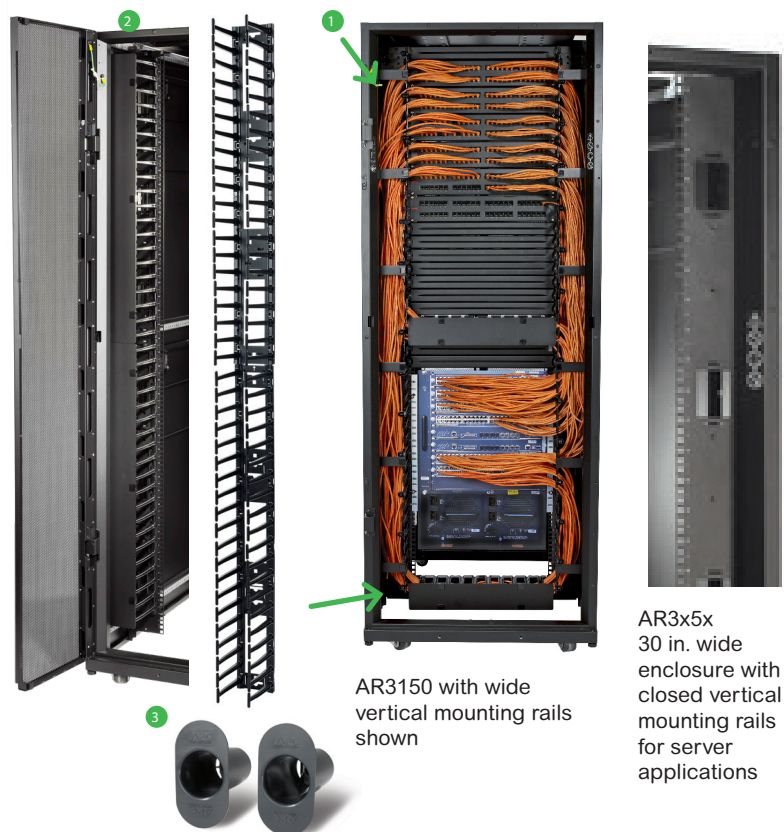

AR3150 with wide vertical mounting rails shown

AR3x5x 30 in. wide enclosure with closed vertical mounting rails for server applications



# NetShelter SX Cable Management

## Overhead cable troughs and partitions

- NetShelter enclosures feature the ability to integrate a system of troughs and partitions for routing power and data cable across the top of the enclosures.
- Troughs and partitions reduce the need for expensive suspended cable tray systems.
- Troughs and partitions install toollessly with snap-in tabs and have standard attachment points for cable ladder systems.
- Enclosure troughs are shown here; for information on power and cooling troughs and partitions, see the [APC website](#).



### 1 Power cable trough

- Supports power distribution cables
- Provides separation from data cables
- Data cables pass through underneath to front partitioned area
- AR8561 — Cable trough, 24 in. (600 mm) enclosures
- AR8571 — Cable trough, 30 in. (750 mm) enclosures

### 2 Pass-through data cable partition

- Partitions the top of the enclosure into cable routing areas
- Pass-through hole provides cable access into multiple cable areas
- AR8163ABLK — Pass-through data partition, 24 in. (600 mm) enclosures
- AR8173BLK — Pass-through data partition, 30 in. (750 mm) enclosures

### 3 Solid data cable partition

- Partitions the top of the enclosure into cable routing areas
- Solid face provides clean appearance at the front of the enclosure
- AR8162ABLK — Solid data partition, 24 in. (600 mm) enclosures
- AR8172BLK — Solid data partition, 30 in. (750 mm) enclosures

### 4 Cable ladders and accessories

Cable ladders and attachment kits for routing power and data cabling overhead from rack to rack



Cable Ladders and Attachment Kits	SKU	Ladder Accessories	SKU
Cable Ladder 6 in. (152 mm) (AR8164AKIT 6 in. ladder with attach kit)	AR8164ABLK	Ladder Corner Clamp	AR8461
Cable Ladder 12 in. (304 mm) (AR8165AKIT 12 in. ladder with attach kit)	AR8165ABLK	Ladder Angle Clamp	AR8462
Alternate Mounting — Ladder to Power Troughs	AR8576	Ladder Stacking	AR8463
Alternate Mounting — Ladder to Data Partitions	AR8177BLK	Ladder Wall Termination	AR8465
Ladder to NetShelter SX Roof	AR8168BLK	Ladder Clamp Kit	AR8169
Ladder Elevation Bracket	AR8186	—	—
Ladder to Two-post Rack	AR8460	—	—



AR8561



AR8162ABLK



AR8163ABLK



AR8186

# NetShelter SX Rack Components

## Replacement doors, side panels, roofs

Standard doors, side panels, and roofs are available for all enclosure sizes. Check the enclosure product page options tab for a list of these rack components.

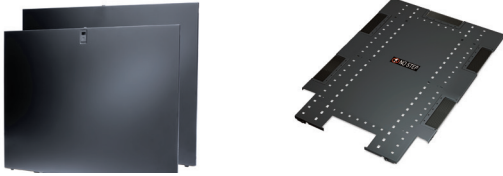

## Specialty roofs, side panels, and accessories

- AR7252\* — Networking roof for high-density cabling 30 in. (750mm) wide x 42 in. (1070 mm) deep
- AR7716\* — Networking roof for high-density cabling 30 in. (750mm) wide x 42 in. (1070 mm) deep
- AR7215 — NetShelter AV enclosure top mount conduit access adapter
- AR7209 — Open roof support bridge for overhead troughs and partitions
- AR7305A — NetShelter SX pass-through side panel 42U x 42 in. (1070 mm) deep
- AR7313 — NetShelter SX pass-through side panel 42U x 47.5 in. (1200 mm) deep
- AR7315 — NetShelter SX pass-through side panel 45U x 42 in. (1070 mm) deep
- AR7316 — NetShelter SX pass-through side panel 45U x 47.5 in. (1200 mm) deep
- AR7375 — NetShelter SX pass-through side panel 48U x 42 in. (1070 mm) deep
- AR7314 — NetShelter SX pass-through side panel 48U x 47.5 in. (1200 mm) deep
- AR7714 — Replacement snap-in brush strips for SX roofs
- ACF501 — Roof fan for 24 in. (600 mm) wide x 42 in. (1070 mm) deep enclosures, 120 Vac
- ACF502 — Roof fan for 24 in. (600 mm) wide x 42 in. (1070 mm) deep enclosures, 208 – 230 Vac
- ACF503 — Roof fan for 30 in. (750 mm) wide x 42 in. (1070 mm) deep enclosures, 120 Vac
- ACF504 — Roof fan for 30 in. (750 mm) wide x 42 in. (1070 mm) deep enclosures, 208 – 230 Vac
- ACF505 — Roof fan for NetShelter AV 24 in. (600 mm) wide x 32.5 in. (825 mm) deep, 115 Vac
- AR8132A — Combination lock handle for NetShelter SX enclosures, qty. 2



AR7252/AR7716



AR7215



AR7209



AR7714



ACF503

## Rails

### Mounting rails

Vertical EIA rail mounting kits for different widths and depths.

- AR7510 — 23 in. (584 mm) EIA mounting rails for 42U x 30 in. (750 mm) wide enclosures



AR7510

### Recessed rail kits

Intermediate mounting rails for supporting shallow depth equipment.

- AR7503 — 42U x 24 in. (600 mm) wide
- AR7504 — 48U x 24 in. (600 mm) wide
- AR7508 — 42U x 30 in. (750 mm) wide
- AR7578 — 48U x 30 in. (750 mm) wide



AR7503

Accessories are now available for pre-integration in NetShelter Racks and Enclosures. For more details see page 37.

[Pre-integrate now >](#)

# NetShelter CX Enclosures

Soundproofed “server room in a box,” that allows for IT deployment wherever and whenever it is needed

Conveniently deploy servers and networking equipment in a quiet, ventilated, secure, and office-ready cabinet. The NetShelter CX is a cost-effective alternative for when there is no space, budget, or time for a traditional server room or wiring closet.



AR4038A – 38U    AR4024A – 24U    AR4018A – 18U    AR4000MVA



## Standard features

**Noise reduction:** 18.5 dB broadband noise reduction

**Cooling system:** Ultra-low-noise exhaust fan module

**Composite wood structure** with acoustic foam lining keeps hardware quiet and secure

**Zero-U Rack PDU:** Each unit includes an APC Basic Rack PDU preinstalled

**Cable management:** Vertical 0U accessory channels located at side at the front, middle, and rear. Cable egress located top/bottom for entry/exit

**Mobility:** Four heavy-duty casters, front wheels 360 degree rotation, rear fixed for stability

**Rear and side access:** Rear and side panels open for equipment installation and maintenance

**Door locking:** Key operated lock, options for combo-style or NetBotz electronic lock

NetShelter SKU	U-space	Height	Width	Depth	Max mounting depth	Fan modules amount & kW	Basic Rack PDU outlets	Packaged
AR4000MVA	12U*	720mm (28 in.)	690mm (27 in.)	930mm (36 in.)	700mm (27.5 in.)	(2 fans) 800 W	3	Standard
AR4018A	18U	1015mm (39 in.)	750mm (30 in.)	1130mm (44 in.)	880mm (34.6 in.)	(1) 1.2	13	Standard
AR4018IA	18U	1015mm (39 in.)	750mm (30 in.)	1130mm (44 in.)	880mm (34.6 in.)	(1) 1.2	13	Standard
AR4018SP	18U	1015mm (39 in.)	750mm (30 in.)	1130mm (44 in.)	880mm (34.6 in.)	(1) 1.2	13	Shock pallet
AR4024A	24U	1285mm (50 in.)	750mm (30 in.)	1130mm (44 in.)	880mm (34.6 in.)	(2) 2.4	12	Standard
AR4024IA	24U	1285mm (50 in.)	750mm (30 in.)	1130mm (44 in.)	880mm (34.6 in.)	(2) 2.4	12	Standard
AR4024SP	24U	1285mm (50 in.)	750mm (30 in.)	1130mm (44 in.)	880mm (34.6 in.)	(2) 2.4	12	Shock pallet
AR4038A	38U	1950mm (76 in.)	750mm (30 in.)	1130mm (44 in.)	880mm (34.6 in.)	(3) 3.6	11	Standard
AR4038IA	38U	1950mm (76 in.)	750mm (30 in.)	1130mm (44 in.)	880mm (34.6 in.)	(3) 3.6	11	Standard

\*AR4000MVA requires use of rail kit AR4000MV12U for u-mounting space



# NetShelter CX

## NetShelter CX with shock packaging

The cabinet is paired with a shock absorbing pallet, unloading ramp and impact resistant shell. The system has been engineered, tested, and approved for secure shipment of fully converged systems such as those certified with Cisco for pre-racking and shipping Cisco Unified Computing System (UCS).



18U NetShelter CX with Shock Pallet for equipment shipment up to 317kg (700 lb.)



AR4024SP - 24U NetShelter CX with Shock Pallet for equipment shipment up to 362kg (800 lb.)



Available as a complete Micro Data Center with integrated power.

[Discover more >](#)

## NetShelter CX Mini

The CX "Mini" is a purpose-built tower server enclosure aimed at small, non-IT spaces such as home office, school, AV, small office, and remote office environments.

### NetShelter CX accessories — Mini

- AR4000MV12U — 12U vertical mounting rail kit for NetShelter CX Mini. Converts basic enclosure to a 12U rack enclosure.
- AR4000MV-FR — Fixed rail kit for NetShelter CX Mini provides two horizontal mounting ledges for equipment placement. Must be used with AR4000MV12U vertical mounting rail kit.
- AR4604 — Bolt-down kit - brackets to secure enclosure to the floor.
- AR4701 — Dust filter pack.
- AR4605 — NEMA input cord and 3 x IEC to NEMA adapter cords.



### NetShelter CX accessories — 18U, 24U, 38U

- AR4604 — Bolt-down kit - brackets to secure enclosure to the floor.
- AR4602A — Allows use of NetShelter SX handles including combination lock handles (AR8132A) and NetBotz Rack Access PX-HID (AP9361).
- AR4701 — Dust filter pack for 18U and 24U. Increases the Ingress Protection Rating (IP) from IP44 to IP54 and reduces the risk of dust-related equipment issues.
- AR4702 — Dust filter pack for 38U. Includes filters for bottom and top of enclosure air intake holes.
- AR4703 — Fan booster increases the CX thermal capacity by up to 40%.
- AR4603 — Base/Plinth surround kit attaches to base of CX and hides casters and support feet.



AR4604



AR4701



AR4702



AR4603

# NetShelter Wall-mount Enclosures

The NetShelter WX wall-mount server rack and network rack solutions provide the functionality required in edge computing applications to be deployed in remote locations with confidence and peace of mind.

## NetShelter 6U Low-Profile Wall-mount Enclosures and Micro Data Centers

APC Wall Mount Micro Data Center is an innovative new way to deploy server and networking equipment at the Edge. The unique low-profile design enables large depth devices to be wall mounted in a compact, and less intrusive form factor than traditional wall mount cabinets.

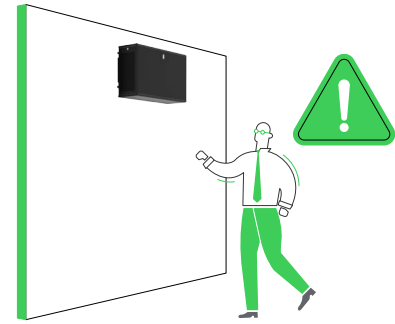

Available as a complete Micro Data Center with integrated power.

[Discover more >](#)

### Enclosure features

- Compact, low-profile design
- Supports latest generation edge server and networking equipment up to 30 in. (762 mm)
- High weight load capacity – up to 250 lb. (113 kg)
- Integrated fans/dust filter
- Wall-mount or floor casters (optional)

### Micro Data Center design highlights

- 1 NetBotz HD Security Camera (optional)
- 2 Universal Accessory Bracket (for non rack-mounted equipment)
- 3 NetBotz Intrusion Detection (optional) — on front, rear and side panel
- 4 1U or 2U UPS (1kVA Lithium pictured)
- 5 NetBotz Temperature/Humidity Sensor (optional)
- 6 2.75 in./1 in. (70mm/28mm) Cable Entry Knockouts (2) Brush Strip Panels (top and bottom)
- 7 Easy, detachable mount wall bracket
- 8 Integrated fan ventilation



NetShelter SKU	Height	U space orientation	Width	Depth	Max rail depth	Static weight capacity	Packaged
AR100	13U	Horizontal	600mm (23.6 in.)	631mm (24.8 in.)	394mm (15.5 in.)	91kg (200 lb.)	Assembled
AR100HD	13U	Horizontal	600mm (23.6 in.)	631mm (24.8 in.)	394mm (15.5 in.)	91kg (200 lb.)	Assembled
AR106	6U	Horizontal	600mm (23.6 in.)	400mm (15.7 in.)	341mm (13.4 in.)	91kg (200 lb.)	Unassembled
AR106SH4	6U	Horizontal	600mm (23.6 in.)	400mm (15.7 in.)	329mm (12.9 in.)	91kg (200 lb.)	Assembled
AR106SH6	6U	Horizontal	600mm (23.6 in.)	600mm (23.6 in.)	499mm (19.6 in.)	91kg (200 lb.)	Assembled
AR106V	6U	Vertical low profile	965mm (38 in.)	331mm (13 in.)	762mm (30 in.)	113kg (250 lb.)	Assembled
AR106VI	6U	Vertical low profile	965mm (38 in.)	331mm (13 in.)	762mm (30 in.)	113kg (250 lb.)	Assembled
AR109	9U	Horizontal	600mm (23.6 in.)	400mm (15.7 in.)	341mm (13.4 in.)	91kg (200 lb.)	Unassembled
AR109SH4	9U	Horizontal	600mm (23.6 in.)	400mm (15.7 in.)	329mm (12.9 in.)	91kg (200 lb.)	Assembled
AR109SH6	9U	Horizontal	600mm (23.6 in.)	600mm (23.6 in.)	499mm (19.6 in.)	91kg (200 lb.)	Assembled
AR112	12U	Horizontal	600mm (23.6 in.)	600mm (23.6 in.)	541mm (21.3 in.)	91kg (200 lb.)	Unassembled
AR112SH4	12U	Horizontal	600mm (23.6 in.)	400mm (15.7 in.)	329mm (12.9 in.)	91kg (200 lb.)	Assembled
AR112SH6	12U	Horizontal	600mm (23.6 in.)	600mm (23.6 in.)	499mm (19.6 in.)	91kg (200 lb.)	Assembled

# NetShelter Wall-mount Enclosures

## Single-hinged Enclosures

The cabinets are compatible with a wide range of APC UPSs, PDUs, and with NetBotz; simply replace the standard swing handle with the NetBotz Rack Access swing handle. NetBotz provides the functionality required at the Edge including remote access, video capture, environmental monitoring with optional smoke, and fluid detection.

All cabinets are UL2416 listed and ship fully assembled. All WX cabinets have a static weight capacity of 91 kg (200 lbs.) making it ideal for roll outs for retail, medical and education. The 600mm deep (23.6 in.) cabinet also provides versatility to mount deep equipment at the point of compute in Edge applications.



AR109SH4 with NetBotz Rack Access, NetBotz appliance, and Smart-UPS

## Unassembled wall-mount Enclosures



AR109

Unassembled enclosures must be assembled on site and offer benefits from a storage and transportation standpoint.

- **AR106** — 6U x 24 in. (600mm) wide x 16 in. (406mm) deep enclosure with perforated door
- **AR109** — 9U x 24 in. (600mm) wide x 16 in. (406mm) deep enclosure with perforated door
- **AR112** — 12U x 24 in. (600mm) wide x 24 in. (600mm) deep enclosure with perforated door
- **AR8213** — Roof fan tray 120V as an accessory for the AR106, AR109, AR112

## Rear-hinged wall-mount Enclosures



AR100

Support remote patching and networking applications in a convenient wall-mount rack with an easy-install rear-hinged section and reversible doors.

- **AR100** — 13U x 23 in. (584mm) wide x 25 in. (635mm) deep, wall-mount enclosure with vented sides and glass front door
- **AR100HD** — 13U x 23 in. (584mm) wide x 25 in. (635mm) deep, wall-mount enclosure with vented sides and full vented front door
- **AR8206ABLK** — Roof fan tray 120V
- **AR8207BLK** — Roof fan tray 208V/230V
- **AR8359** — Caster kit
- **AR8355** — Ventilation plates



# Open Frame Racks

## NetShelter two- and four-post open frame racks

The NetShelter two- and four-post open frame racks offer a quality solution for the economical installation of rack-mountable equipment, where security at the individual rack level is not required. Open frame racks provide unobstructed airflow and fast, easy access to installed equipment, and can be paired with high-density vertical cable managers for maximum cable volume. The two-post rack offers cost-conscious customers a simple solution for supporting networking equipment and patching applications. The four-post rack offers more strength and features for supporting servers and networking equipment. Recent improvements to the four-post racks increase cable management options and flexibility.



Performance vertical cable managers AR8625 and AR8765 shown

## Performance vertical cable managers

- Preassembled, ready for installation
- Fits two- and four-post open frame racks 84 in. (2133 mm) height
- Slam-to-latch full length door opens to left or right
- Cable management backplate or midspan bracket for toollessly mounting cable management accessories and rack PDUs
- AR8615 — 6 in. (152 mm) wide, single-sided
- AR8625 — 6 in. (152 mm) wide, double-sided
- AR8635 — 10 in. (254 mm) wide, single-sided
- AR8645 — 10 in. (254 mm) wide, double-sided
- AR8665 — 12 in. (304 mm) wide, single-sided
- AR8675 — 12 in. (304 mm) wide, double-sided

## AR201 — two-post rack

- Self-squaring design
- 45U mounting spaces - 84 in. (2133 mm) tall
- Black finish
- 6061-T6 structural grade aluminum
- Weight capacity (static load) 750 lb. (340 kg)

## AR203A/AR204A — four-post rack

- Threaded #12-24 holes (AR204A)
- Square holes for cage nuts and server mounts (AR203A)
- New design for easier assembly
- Steel construction
- 44U mounting spaces - 84 in. (2133 mm) tall
- Black finish
- Multiple toolless mounting points for hook-and-loop fasteners (AR8621) or toolless cable management rings (AR7540)
- Multiposition rack PDU mounting bracket (AR8652)
- Reversible stabilization plates
- Grounding inserts
- Weight capacity (static load) 2,000 lb. (907 kg)



## VDIM33174 — 4U overhead patch frame

- 19 in. (482 mm) frame
- Weight capacity up to 33 lb. (14 kg)
- Attaches to cable ladder and wire basket trays for network patching overhead row



## Vertical cable managers

- Unassembled option for site assembly
- Fits two- and four-post open frame racks
- Cable management backplate for toollessly mounting cable management accessories
- AR8715 — 6 in. (152 mm) wide, 84 in. (2133 mm) height, single-sided
- AR8725 — 6 in. (152 mm) wide, 84 in. (2133 mm) height, double-sided
- AR8728 — 6 in. (152 mm) wide, 96 in. (2438 mm) height, single-sided
- AR8765 — 12 in. (304 mm) wide, 84 in. (2133 mm) height, single-sided
- AR8768 — 12 in. (304 mm) wide, 96 in. (2438 mm) height, single-sided
- AR8775 — 12 in. (304 mm) wide, 84 in. (2133 mm) height, double-sided

# Open Frame Racks

## Performance vertical cable manager: Accessories and applications

### 1 AR8444 — Cable slack spools

- Toollessly mounts on back panel
- Provides smooth radius support for cable slack



### 2 AR8621 — Toolless hook-and-loop cable managers

- 18 in. (457mm) straps for large data cable bundles
- Various mounting positions on back panel of vertical cable managers



### 3 AR8680 — Cable divider/organizer

- For creating multiple cable pathways within vertical cable managers
- Includes tie-off features for securing cabling using toolless hook-and-loop cable managers (AR8621)



### 4 Vertical rack PDUs and patching

- Cable management backplate (single-sided) or midspan brackets (double-sided) allow:
  - Toollessly mount, front or rear, multiple vertical rack PDUs
  - 19 in. (482mm) patch panels can be installed vertically (double-sided only)

## Four-post rack accessories

### AR8652 — Rack PDU mounting bracket

- Mounts on sides as a spacer when using vertical cable managers between two racks
- Mounts on face of vertical rails, perpendicular, for single rack applications
- Designed to toollessly mount APC rack PDUs

### AR8450A — Trough and partition adapter

- Provides mounting locations for overhead trough and partition cable management system



AR8652 mounted on right rear corner of four-post rack with rack PDU



# NetShelter Custom and Specialty Enclosures

## NetShelter custom racks and enclosures

Assembled and configured-to-order or completely customized rack systems.

Offering customization services to our data center customers with cabinets and rack power distribution products. Your customer's needs, our engineering expertise. Dedicated engineering team to define needs, set expectations, build prototypes, co-engineer, and execute a customized solution.



Custom colors

Custom heights  
54U to 60U

Custom depths

Custom architectures

Custom logos

## Hear what our customers have to say about our Custom Rack capabilities

### Try Before You Buy: Build Your Data Center Design at World Wide Technology's (WWT) Advanced Innovation Center

WWT is like what testing tracks are to new car development. The Advanced Technology Center (ATC) brings together a range of data center solutions in one location as a proving ground. Live working data centers can be built and rebuilt quickly and easily to simulate business needs. WWT relies on customized racks, power, and cooling from APC to create such flexibility.

[View the case study](#)

### Delivering Hyperscale Higher Density Through Customized Data Center Racks On Demand

Schneider Electric builds specialized equipment for switch's colocation data centers with custom colors, logo, and unique design for Switch containment systems.

[View the case study](#)

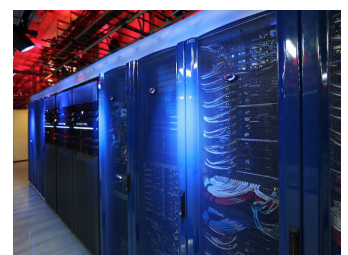
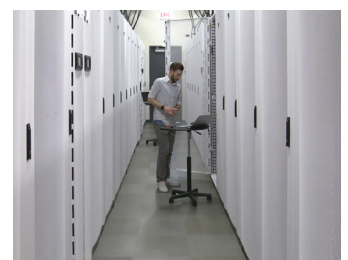

Discover more custom rack systems >

Or contact local sales representative to request a custom rack today!



# NetShelter Custom and Specialty Enclosures

## NetShelter Assemble-to-Order

The Cabinet ATO (Assemble-to-Order) provides a level of customization for cabinet customers beyond the standard cabinet SKUs. For example, the cabinet can be assembled without sides, doors, or a roof. In addition, special mounting rails can be installed in place of the standard square hole rails for customers requiring threaded options or 23 in. (584 mm) EIA mounting. To request an ATO cabinet configuration contact an APC sales representative.

### Alternate roof designs:

- Server or networking
- Fan tray
- Open roof bridge
- No roof

### Alternate side panels:

- Pass-through brushes
- Sides only where needed
- No sides

### Cabinet colors:

- Black
- White

### Packaging:

- Standard
- For equipment shipment up to 2,000 lb. (907 kg)



### Alternate mounting rail configurations:

- Preset to specific depth
- Alternate mounting holes
- M6, 10-32, 12-24, 23 in. EIA

### Alternate door handles:

- Standard handle
- Combination style

### Alternate door configurations:

- Single or split doors front/back
- No doors



## Common ATO configurations

For common requests, such as cabinets without sides or without sides and doors, generic part numbers have been set up to provide faster assistance.

[View the chart on page 7](#) for enclosures available as ATO configurations without sides or without sides and doors.

## NetShelter seismic enclosure

Enclosure designed for essential facilities and carrier applications in seismic environments. Meets NEBS test standard GR-63-CORE Zone 4 at 1,000 lb. (453kg) equipment load.

- AR2144BLK — 42U x 24 in. (600mm) wide x 42 in. (1070mm) deep, NEBS enclosure, with sides
- AR2145BLK — 42U x 24 in. (600mm) wide x 42 in. (1070mm) deep, NEBS enclosure, without sides

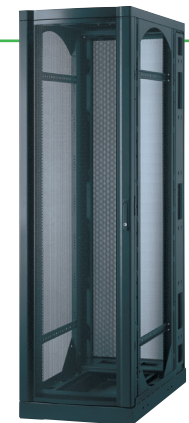

AR2145BLK

# Introducing APC Easy Racks



From APC comes reliable, affordable, and easy to use series of racks and accessories from a trusted brand. These racks are easy to choose, install, and accessorize with APC accessories and are available in a variety of sizes that allows this series scalability for IT deployments from network closets to data centres.

## Fast Deployment

- Fully assembled, also option as flatpack unassembled
- Key features for fast deployment
- APC solution compatibility

## Standardization

- Several heights, widths, depths and with and without sides for any IT application
- Standardize on a single platform from the edge to data centre
- Base building block of data centre and micro data centre solutions

## Reliable

- APC quality and reliability
- Industry standards adherence: EIA-310-E compliant and UL Listed
- Standard 5 year factory warranty

From network closets to data centre...

## Easy Rack for data centre

As the main carrier of IT equipment, the rack is the cornerstone of the data centre, based on the current IT market server and network application trends Easy Rack offers a wide variety of IT rack designs suitable for any IT application server, network, storage, and converged IT.



## Easy Rack at the Edge

APC Easy Rack provide a variety of configurations to meet the high security, cost-effective, and rapid deployment requirements of edge systems. 24U and 800mm deep form factors make these racks suitable for smaller spaces often out at the edge of networks.



## Typical applications

- Cloud and Service Providers / Colocation
- Small, medium, large data centre
- Enterprise Edge Computing



# Easy Rack Key Features

## Half height side panels

- Easy to use and handle
- Lockable top side panels
- Tool-free installation



## Multi-functional roof

- Roof openings with brush strips for managing cabling and proper airflow management
- Compatible with APC overhead cable management system of troughs and partitions

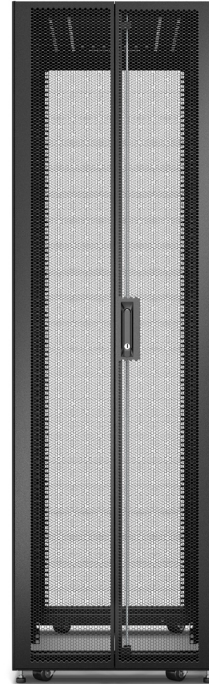

## Rear accessory brackets

- 4 accessory brackets pre-installed to support toolless installation of full cabinet height vertical Rack PDUs
- Add additional brackets to support toolless installation of half height PDUs and cable managers or replace completely with accessory channels

## Integrated electrical grounding

- Grounding connections on doors
- Roof, side panels, doors are grounded to the frame of the enclosure
- Additional external grounding locations front / rear

## Ventilated front/rear doors

- Single open vented front door and split rear doors
- Up to 81% perforation
- Hexagonal pattern

## Additional features:

- Industry proven frame design
- Supports racks with or without side panels
- Static load rating: 1200kg
- Dynamic load rating: 600kg
- Tool-free installation of Rack PDUs
- 24, 42, and 48U designs
- 600, 800mm widths and 800, 1000, 1100, 1200mm Depths
- Flatpack unassembled option available for deployment in spaces a full assembled rack cannot be transported to

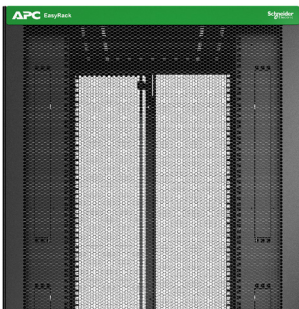

## 800mm Racks Feature:

- Up to 16 x 1U vertical knockout panels located within the front and rear equipment mounting rails (12 in 42U)
- Vertically mount patch panels or 1U devices and save horizontal mounting space for other IT devices



# Easy Rack Selection

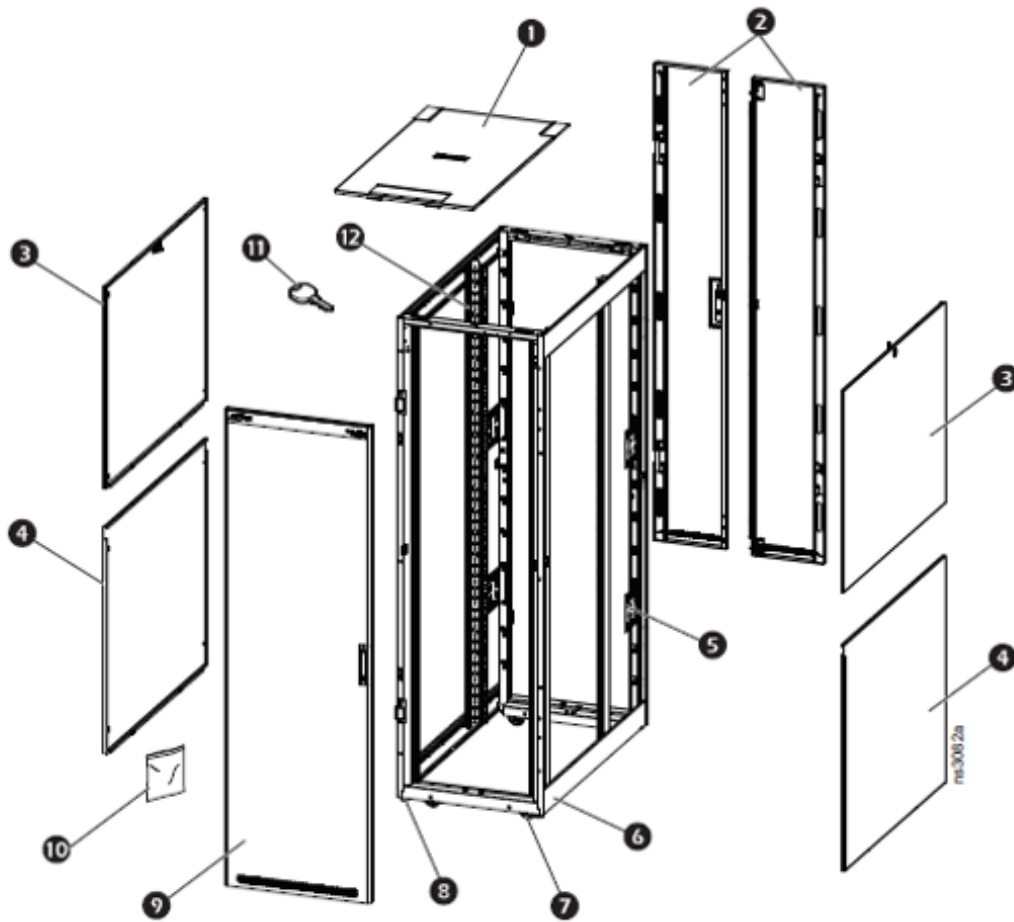

## Rack Components

- 1. Roof
- 2. Rear doors
- 3. Removable top side panel (locking)
- 4. Removeable bottom side panel
- 5. Zero U accessory mounting brackets
- 6. Cabinet frame
- 7. Casters
- 8. Levelling feet
- 9. Removable and reversible front door
- 10. Hardware bag

SKU	U Space	Width (mm)	Width (mm)	Height C(mm)	Height D(mm)	Net Weight (kg)	Shipping Dimensions	Packaged Weight (kg)	Option Without Sides
ER6222	42U	600	1200	1955	1991	108	650 x 1250 x 2120	116	ER6220
ER6212	42U	600	1100	1955	1991	105	650 x 1150 x 2120	112	
ER8222	42U	800	1200	1955	1991	135	850 x 1250 x 2120	144	ER8220
ER8212	42U	800	1100	1955	1991	131	850 x 1150 x 2120	140	
ER6822	48U	600	1200	2222	2258	122	650 x 1250 x 2390	130	ER6820
ER8822	48U	800	1200	2222	2258	150	850 x 1250 x 2390	159	ER8820
ER6202	42U	600	1000	1955	1991	100	650 x 1050 x 2120	106	ER6200
ER6202FP1*	42U	600	1000	1955	1991	100	650 x 1050 x 2120	106	
ER8202	42U	600	1000	1955	1991	128	850 x 1050 x 2120	137	ER8200

\*Unassembled and flatpacked rack option and must be assembled onsite.

# Rack Cooling and Airflow Management

## NetShelter Data Center Containment

NetShelter Data Center Containment can be deployed at the rack, row, or room level. In addition to maximizing network availability and performance, the solutions provide a significant OpEx savings by minimizing the power consumption of the cooling equipment.

## NetShelter Pod Containment

Rack-ready system designed to deploy IT at scale in increments of 8-to-12 racks. The backbone of the solution is a freestanding structure that supports necessary IT infrastructure while providing air containment for all rack types. It is designed to easily integrate with a variety of cooling and power configurations.



NetShelter Pod Containment

## NetShelter Aisle Containment

The NetShelter Aisle Containment system adapts to varying rack heights, aisle widths, and rack depths to support either hot or cold aisle containment. The Air Return System of the NetShelter Aisle Containment provides a centralized hot air return path for room-based computer room air conditioner units or external air handling systems.

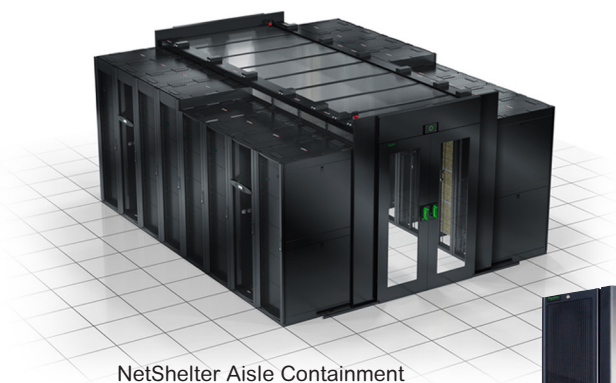

NetShelter Aisle Containment

## NetShelter Rack Containment

The NetShelter Rack Containment modular design easily adapts to both the front and rear of the racks and close-coupling cooling units, simplifying installation. The NetShelter Rack Containment features a scalable open plenum that enables capacity sharing to improve cooling system redundancy and utilization.



NetShelter Rack Containment

Available as a complete Data Center Solution with integrated power, rack, and cooling.

[Discover more >](#)

**EcoEtruxure™**  
Innovation At Every Level

# Passive Cooling Accessories

## Air sealing

Covers open rack space to prevent air recirculation and reduce bypass airflow to improve cooling efficiency.



AR8136BLK installed

- AR8136BLK — 1U toolless snap-in blanking panel, 10 pk (AR8136WHT white version)
- AR8136BLK200 — 1U toolless snap-in blanking panel, 200 pk (AR8136WHT200 white version)
- AR8108BLK — 1U standard metal blanking panel, 2 pk
- AR8101BLK — 1U, 2U, 4U, 8U, blanking panel kit
- AR7708 — NetShelter SX Air Recirculation Prevention Kit for closing gaps and pass-through holes between side panels and equipment mounting rails
- AR7731 — NetShelter SX external air sealing kit seals external openings at roof and floor, 10 pk



## KoldLok® raised floor grommets AR7731

Seal a variety of cutouts in a raised floor environment to reduce cold air leakage and improve cooling efficiency under the raised floor.

- AR7720 — Integral raised floor grommet (enclosed) for new installation, 10 pk
- AR7730 — Surface-mount raised floor grommet (split) for existing cables, 10 pk
- AR7740 — Extended raised floor grommet to cover length of floor tile, 10 pk

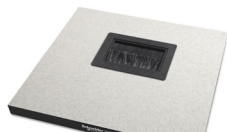

AR7720



AR7740

## Side airflow cooling

Support cooling for small and large networking switches mounted within networking enclosures.

- AR7742 (42U)/AR7747 (48U) — Side airflow solution for Cisco Nexus 7018 attaches to sides of 47.5 in. deep enclosures. For more detail [see page 8](#).

## Ducting only

Vertical Exhaust Duct (VED) for NetShelter SX is an easy-to-install, low-cost cooling option that can increase the efficiency of the attached cooling system.

- AR7751 — VED for 24 in. enclosures, short range
- AR7752 — VED for 24 in. enclosures, tall range
- AR7753 — VED for 30 in. enclosures, short range
- AR7754 — VED for 30 in. enclosures, tall range
- AR7755 — Overhead cable extension for VED 24 in.
- AR7756 — Overhead cable extension for VED 30 in.



AR7751 and AR7755 installed on AR3300 with cable management



VEDs also available in white.

Roof fan trays available for 42 in. deep enclosures,

## Active cooling accessories

### Rack mounted cooling

Rack mounted cooling solution to meet the specific needs of Micro Data Center and Edge computing solutions.



- ACRMD4KT-1 — 3.5kW split system indoor unit, gravity drain
- ACRMD4KT-2 — 3.5kW split system outdoor unit, pre-charged refrigerant

### Rack fan panel

2U rack-mounted fan panel and accessories.

- ACF600 — 2U rack fan panel
- ACF601 — Rack fan panel temperature controller
- ACAC40000 — 2U vent panel with temperature display
- ACAC40001 — 2U vent panel



ACF600



# NetShelter Rack Power Distribution

Global power densities are increasing and becoming more unpredictable. Whether deploying rack power distribution in a wiring closet, server room, or data center, APC offers a consistent way to meet a variety of power density applications up to 22 kW per strip.

APC Rack PDUs have sufficient power and receptacle outputs to meet high kW loads in a minimal amount of space. Their ease of installation accelerates speed of deployment and reduces installation costs. With advanced rack power distribution, APC offers real-time remote load monitoring of connected equipment and individual outlet power control for remote power recycling.

## Manage power at the rack level with pinpoint control

- Basic Rack PDU — Entry-level power distribution for rack-mount equipment
- Metered Rack PDU — Advanced power distribution provides real-time remote monitoring of connected loads
- Switched Rack PDU — Premium power distribution allows remote control of individual outlets and monitoring of aggregate current consumption
- Metered-by-Outlet — Provides real-time remote monitoring of each individual outlet
- Rack Automatic Transfer Switch — Provides redundant power to single-corded equipment

## The Metered and Switched Rack PDU offers advanced features to meet today's data center demands

Monitors input and all breakers on the strip (local and remote) and offers user-customizable warning and overload settings, plus automated alarm notifications. Enables enhanced capacity management and network management.

- Web interface
- Telnet, SNMP
- Security
- Schneider Electric EcoStruxure IT Expert



**EcoStruxure™**  
Innovation At Every Level

## Rack PDU local display

Load indicator LEDs      Serial connection: local configuration and out-of-band management

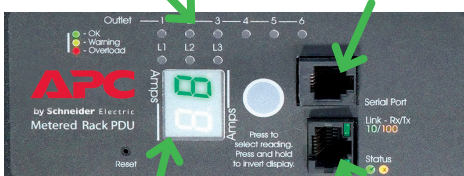

Local two-digit LED current monitoring display

Network management: access, configure, and receive warnings from remote locations via Web, SNMP, and Telnet

User interactive display for local access

Environmental monitoring port for external temperature/humidity probe

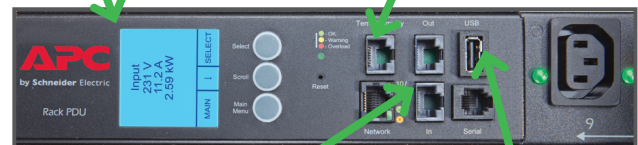

CAN In/Out ports for future functionality

Local USB port for flashing firmware updates and downloading data/event logs (not to be used as serial port)

Color user-interactive display for local access

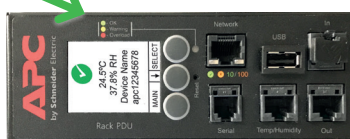

APF8000



APF8000D

Color user-interactive display for local access

# NetShelter Rack Power Distribution

## Factory-Configurable: Pick and choose outlets, color, and more

New architecture takes APC from a standard catalog of hundreds of products to thousands of configurable options. Factory options include outlets, input cord type and length, and color.



### Overview

- Factory-configurable family types\*: Metered by Outlet, Switched, and Switched with Metering by Outlet
- Voltage: 200 — 415V
- Amp: 20 — 60A
- Outlet capacity: Up to 48 outlets — C13s, C19s
- Mount style: Vertical

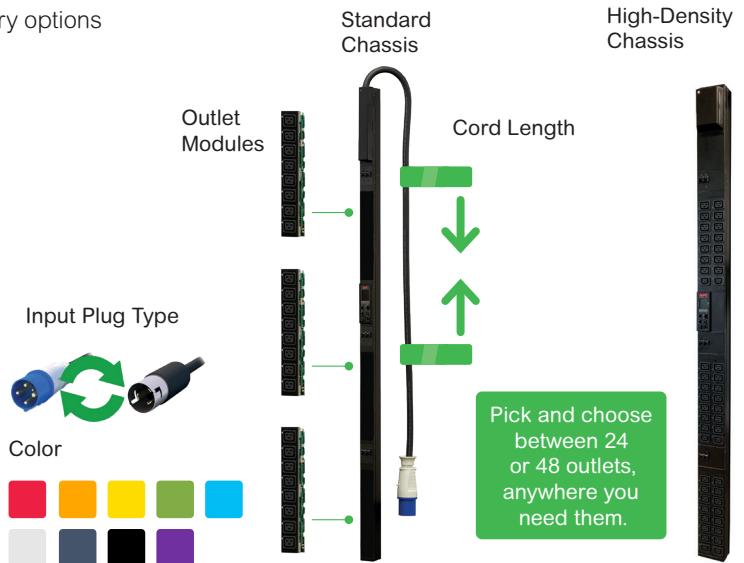

To configure your PDU today visit: [apc.com/configurerackpdu](http://apc.com/configurerackpdu)  
\*Visit apc.com for country availability.

## NetShelter rack-mount transfer switch



Input voltage	Mounting U-space	Input circuit	Input plug type	Output receptacles	Cord length	APC SKU
100/120V	1	15A	NEMA 5-15P	(10) 5-15R	2.4 m	AP4450
120V	1	20A	NEMA L5-20	(10) 5-20R	2.4 m	AP4452
100V	1	20A	NEMA L5-20	(8) 5-15R	2.4 m	AP4452J
120V	2	30A	NEMA L5-30P	(16) 5-20R	2.4 m	AP4453
200/208V	1	20A	NEMA L6-20	(8) C13, (1) C19	2.4 m	AP4430
208V	2	30A	NEMA (2) L6-30P	(1) L6-30R	2.4 m	AP4431
200/208V	2	30A	NEMA L6-30	(16) C13, (2) C19	2.4 m	AP4432
208V	1	12A	IEC-C14 in	(12) C13	None	AP4433
208V	1	20A	IEC-C20 in	(8) C13, (1) C19	None	AP4434
230V	1	10A	IEC-C14	(12) C13	None	AP4421
230V	1	16A	(2) IEC-309	(1) IEC 309	2.4 m	AP4422
230V	1	16A	IEC-C20	(8) C13, (1) C19	None	AP4423

Accessories are now available for pre-integration in NetShelter Racks and Enclosures. For more details see page 37.

Pre-integrate now >

# Easy Rack PDUs

## Make Power Distribution Easy

APC Easy Racks PDU provides easy-to-install, easy-to-use, reliable power distribution to connected loads. Flexible monitoring and configuration options help you meet the unique needs of your IT environment.

### Easy Basic Rack PDUs

Reliable power distribution

### Easy Metered Rack PDUs

...Real-time remote monitoring of connected loads

...User-defined alarms warn IT and data center managers of potential circuit overloads to prevent accidental power loss to critical equipment

### Easy Switched Rack PDUs

...Metered functionality

...Remotely switch on/off the connected power load



### Easy for installation

...Ultra lightweight thanks to aluminum housing

...Support both toolless mounting and bracket mounting

...Built-in input cord with industrial connector for vertical PDU

...Low-profile in depth for more convenient equipment installation

### Easy for operation and maintenance

...User-friendly and simple Web interface and LCD screen

...Support network port, easy for data communication

...Field-replaceable control module, easy for maintenance

	Basic	Metered	Switched
<b>Design Feature</b>			
Ultra low-profile in depth	✓	✓	
Hydraulic-magnetic circuit breakers (in units with 32A input current)	✓	✓	✓
Environmental monitoring port for external temperature/humidity monitoring		✓	✓
Availability for regional outlets socket type	✓		
<b>Display and network management</b>			
Full-featured network management capability via web, SNMP		✓	✓
User-interactive LCD display for local access		✓	✓
Field-replaceable network management module		✓	✓
Network port sharing ( up to four Rack PDUs share one IP address )			✓
<b>Metering capability</b>			
Active current measurements (amps)		✓	✓
Active power measurements (including volts, amps, real power (kW) and energy (kWh))		✓	✓
User-customizable alarms and warnings		✓	✓
Embedded log memory to record/review/repor		✓	✓
Use access control with two levels		✓	✓
<b>Outlet control</b>			
Individual outlet remote power on/off control			✓
Power-on sequencing and time delays with full user customization			✓
Outlet level grouping (multiple outlets in same or multiple units follow single command)			✓
Use access control with two levels		✓	✓
<b>Installation and maintenance</b>			
Ultra-light for installation	✓	✓	
Field-replaceable network management module		✓	✓



# NetBotz Security and Monitoring

Security and environmental monitoring for network closets to data centers

## Surveillance

- Leverage NetBotz and IP camera technology to monitor IT assets remotely
- EcoStruxure IT Expert and the NetBotz Surveillance package allow multiple site camera views on a single page

## Environmental monitoring

- Wide range of wired and wireless sensor support to monitor the health of your IT assets
- Temperature, humidity, leak, door, smoke, vibration, dew point, airflow, dry contact, 4-20mA, and 0-5V

## Management capabilities

- Alarming allows alerts, multiple notification methods, scheduling, graph and video attachments, escalation.
- Integrate with EcoStruxure IT Expert to manage multiple NetBotz devices through a single interface and view historical alarms and sensor data.

Flexible access control for NetShelter SX, SV, CX, and wall-mount racks

Configure proximity cards for access or control access via web browser for remote management and notification.

## APC Rack Access control options:

### 125 kHz Access Control

- Stand-alone appliance for two handles to plug into (i.e., one appliance per rack)
- Leverages the Netbotz 250
- Central authentication via RADIUS
- Remote Syslog capability



### 13.56 MHz Access Control

- Stand-alone appliance for two handles to plug into (i.e. one appliance per rack)
- Leverages the Netbotz 250
- Central authentication via RADIUS
- Remote Syslog capability



### Rack Access Pods

- Rack access pod that is daisy chained off a Netbotz 750 or 755 appliance
- Basement or 19 in. mounting
- Supports NetShelter SX, SV, and CX\*
- Supports up to 200 unique users



\*Note: NetBotz Access Control requires adapter kit for NetShelter CX



**EcoStruxure™**  
Innovation At Every Level

Accessories are now available for pre-integration in NetShelter Racks and Enclosures. For more details see page 37.

Pre-integrate now >

# LCD Monitors and KVM Switches

Optimize rack space.

Maximize system visibility.

Rack LCD Consoles include a keyboard, mouse, 17 in./19 in. LCD console, and optional integrated 8/16 port analog KVM switch (17 in. model only), all in a compact 1U design. This compact design allows a KVM switch to be mounted in the rear of the Rack LCD Console or eliminates the need for a separate KVM switch altogether by choosing a Rack LCD Console with integrated 8/16 port analog KVM switch.

The console is easily installed and minimizes support and maintenance costs, ensuring lower cost of ownership. The ultra-thin LCD screen, touch pad technology, and easy-to-install single user rack-mount kit combine to form a high-quality, streamlined solution built for server management. The Rack LCD Consoles can be used in a variety of IT environments, from computer rooms to large data centers.

- Ultra-thin 17 in. or 19 in. LCD monitor
- Integrated keyboard with number pad
- USB port for external media
- Space-saving 1U design
- Touch pad mouse
- Easy to install

Access your servers across the room or across the world. APC Rack KVM switches empower IT administrators through both local and remote POST- and BIOS-level access and control of connected servers. APC Analog, CAT-5 Analog, and IP KVM switches help reduce total cost of ownership — minimizing space, hardware, electricity, and cabling by leveraging just one keyboard, monitor, and mouse for multiple servers.



AP9224110

Ethernet switch with CAT-5 type connection	SKU
24 Port 10/100 Ethernet Switch	AP9224110



AP5201

KVM switches with coaxial-type connection	SKU
8-Port Analog KVM	AP5201
16-Port Analog KVM	AP5202



AP5808

LCD console	SKU
17 in. Rack LCD console	AP5717
19 in. Rack LCD console	AP5719

LCD LCD console with integrated KVM switches	SKU
17 in. Rack LCD console with integrated 8-port KVM switch	AP5808
17 in. Rack LCD console with integrated 16-port KVM switch	AP5816
KVM USB cable, 6 ft.	AP5821
KVM USB cable, 12 ft.	AP5822
KVM USB cable, 25 ft.	AP5823



AP5816

KVM switches with CAT-5 type connection	SKU
16-port digital IP KVM with virtual media, one remote user	KVM1116R
16-port analog enterprise KVM with virtual media, two local users	KVM0216A
16-port analog KVM, one local user	KVM0116A
8-port analog KVM, one local user	KVM0108A
KVM DVI server module with virtual media and KVM-HDMI/MCACC CAC support	KVM-DVIVMCACC
KVM HDMI server module with virtual media and KVM-HDMI/MCACC CAC support	KVM-HDMIVMCACC
KVM USB server module	KVM-USB
KVM PS/2 server module	KVM-PS2
KVM USB server module with virtual media	KVM-USBVM
KVM PS/2 server module with virtual media	KVM-PS2VM
KVM USB server module with virtual media and CAC support	KVM-USBVMCACC
KVM serial server module	KVM-SERIAL
KVM to rack PDU power management cable	AP5641
KVM 1U bracket for rear mount behind rack LCD console	KVM-LCDMOUNT
KVM access software license upgrade to enterprise (1,024 Nodes)	SEKVM1024N

Cables	2 ft.	3 ft.	6 ft.	12 ft.	25 ft.
KVM USB cable			AP5253	AP5257	AP5261
KVM PS/2 cable		AP5264	AP5250	AP5254	AP5258
KVM Daisy-chain cable	AP5262		AP5263		

# NetShelter Cable Management

## Toolless accessories

### Vertical cable management

APC specializes in toolless-install accessories by the use of the zero-U channels located in the rear of every NetShelter SX enclosure.

#### 1 Vertical 0U accessory for NetShelter SX

- Allows toolless mounting of vertical rack PDUs
- Toollessly mount vertical cable organizers
- Additional vertical 0U accessory channels:
  - AR7502: Vertical 0U accessory channel, 42U, qty. 2
  - AR7552: Vertical 0U accessory channel, 45U, qty. 2
  - AR7572: Vertical 0U accessory channel, 48U, qty. 2
  - AR7511: Narrow vertical 0U accessory channel, 42U
  - AR7505: Vertical cable organizer, center rear mount

#### 2 AR8442 — Vertical cable organizer, eight cable rings, zero U

- Supports 35 to 55 CAT 6/CAT 6A data cables
- Mounts toollessly on the vertical 0U accessory channel

#### 3 AR8443A — Vertical fiber organizer

- Installs toollessly
- Takes up one bay of channel
- Fiber spool only kit available (AR8444)

#### 4 AR8457 — Data distribution 0U SX panel

- Installs toollessly
- Takes up one bay of channel
- Toollessly mount up to four DDC cable heads, 24 ports for rack-to-rack connections

#### 5 AR7710 — Cable containment brackets with rack PDU mounting

- Low-profile vertical cable management
- Supports 60 to 90 CAT 6/CAT 6A data cables
- Mounts toollessly on the vertical 0U accessory channel

#### 6 AR7711 — Zero-U accessory bracket

- Mounts rack PDUs in rear-facing orientation
- Supports third-party accessories in numerous mounting configurations
- Mounts 1U or 2U patch panels or other networking accessories

#### 7 AR8621 — Hook-and-loop cable managers, qty. 10

- Mount toollessly on the vertical 0U accessory channel
- Secure and bundle cables with hook-and-loop ties

#### 8 AR7721, 22, 23 — Low-profile vertical cable managers, zero U

- Supports up to 38 CAT 6A or 251 fiber cables
- Mounts toollessly on the vertical 0U accessory channel

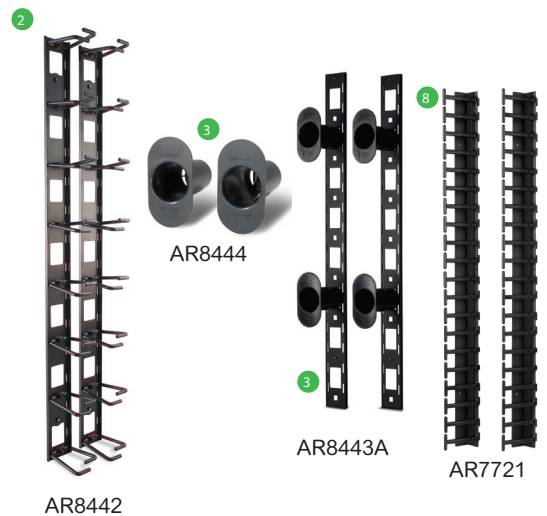

AR8442

AR8444

AR8443A

AR7721



AR8457



AR7710

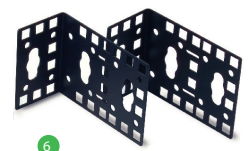

AR7711



AR8621



# NetShelter Cable Management

## Horizontal cable managers

### Finger-type horizontal cable managers

Cable managers for patching and crossover applications featuring smooth radius plastic fingers that protect the cable from kinking and binding. Hinged, snap-on covers provide a clean look and retain large cable bundles. These cable managers include hardware for double-sided configurations with two units.

- AR8602A — 1U horizontal cable manager with 4 in. (101 mm) fingers and snap-on cover
- AR8600A — 2U horizontal cable manager with 4 in. (101 mm) fingers and snap-on cover
- AR8612 — 1U horizontal cable manager with 6 in. (152 mm) fingers and snap-on cover
- AR8606 — 2U horizontal cable manager with 6 in. (152 mm) fingers and snap-on cover
- AR8603A — 2U horizontal cable manager with 6 in. (152 mm) fingers, snap-on cover, rear cable pass-through holes, and slots for AR8008BLK/AR8016ABLK horizontal cable channel
- AR8605 — 3U horizontal cable manager with 6 in. (152 mm) fingers, snap-on cover, rear cable pass-through holes, and cable channel slots

### Ring-type horizontal cable managers

Economical cable managers for patching applications featuring various configurations to meet specific needs.

- AR8425A — 1U horizontal cable manager with four rings
- AR8426A — 2U horizontal cable manager with four rings
- AR8428 — 2U horizontal cable manager with four rings and pass-through holes
- AR8427A — 2U horizontal cable manager with multiple rings and small cable retainers
- AR8113A — Cable management rings, qty. 5 large, 5 small
- AR7707 — Cable management rings, 8 in. (203 mm) deep for 30 in. (750 mm) wide enclosures (AR3x5x), qty. 8

### Horizontal cable management accessories

- AR8429 — 1U cable pass-through manager with brush strip
- AR8129 — Cable management arm for use with sliding shelves
- AR8008BLK — Horizontal cable side channel (18 in. [457 mm] to 30 in. [750 mm] adjustment) for routing cable front-to-back between the standard wide rack mounting rails or AR8603 and AR8428 horizontal cable managers
- AR8016ABLK — Horizontal cable side channel (10 in. [254 mm] to 18 in. [457 mm] adjustment) for routing cable front-to-back between the standard wide rack mounting rails or AR8603 and AR8428 horizontal cable managers
- AR7706 — Mounting rail brush strips for 30 in. (750 mm) wide enclosures (AR3x5x), qty. 6

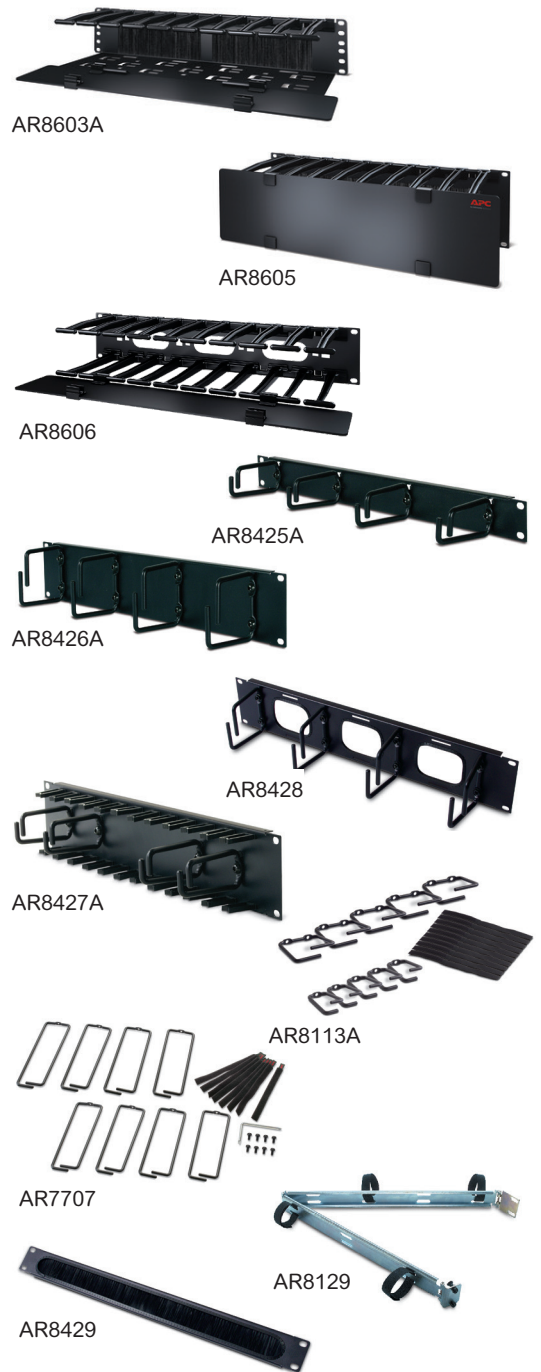

Accessories are now available for pre-integration in NetShelter Racks and Enclosures. For more details see page 37.

[Pre-integrate now >](#)

# Shelves and Mounting Hardware

Mounting accessories to aid in the installation of IT equipment and secure racks into position

## Shelving

Fixed and sliding shelves to enable the mounting of tower units, monitors, and other equipment into the rack environment.

- AR8105BLK — Fixed shelf 50 lb. (22 kg)
- AR8122BLK — Fixed shelf 250 lb. (113 kg)
- AR8123BLK — Sliding shelf 100 lb. (45 kg)
- AR8128BLK — Sliding shelf 200 lb. (90 kg)
- AR8422 — Double-side fixed shelf for two-post rack
- AR8126ABLK — 17 in. (431 mm) sliding keyboard shelf
- AR8127BLK — 19 in. (482 mm) sliding rotating keyboard shelf
- AR8006A — Miscellaneous equipment support rails for 24 in. (600 mm) wide enclosure



AR8105BLK

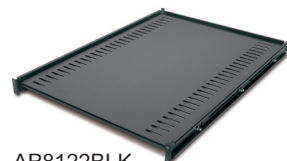

AR8122BLK

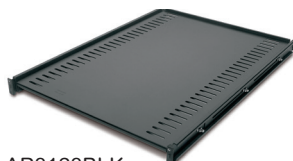

AR8128BLK



AR8422

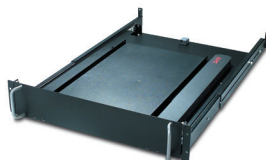

AR8126ABLK/AR8127BLK

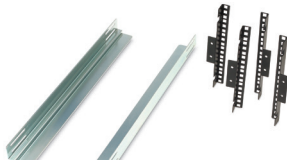

AR8006A

## Bolt-down and stabilization

Stabilization plates and hardware to prevent tip over in stand-alone rack applications and meet specific anchoring requirements.

- AR7700 — NetShelter SX stabilization plate to prevent tipping when sliding out equipment
- AR7701 — NetShelter SX bolt-down kit — meets IBC seismic requirements for moderate seismic zones
- AR7701-S — NetShelter SX bolt-down kit — meets IBC seismic requirements for high seismic zones



AR7701 & AR7701-S



AR7700

## Miscellaneous mounting brackets

Variety of mounting brackets for mounting IT equipment.

- AR7711 — Zero-U multipurpose accessory mounting bracket for side mounting of 1U/2U products and rack PDUs
- AR8150BLK — 23 in. (584 mm) to 19 in. (482 mm) mounting adapter brackets for use with AR7510 23 in. (584 mm) EIA mounting rails



AR7711

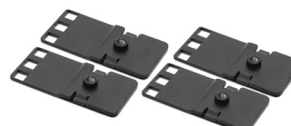

AR8150BLK

## Hardware kits

Available for additional hardware needs or to accommodate equipment mounted in varying mounting options.

- AR8100 — M6 cage nuts and screws, qty. 32
- AR8400 — #12-24 screws, qty. 100
- AR8005 — #10-32 cage nuts, qty. 36

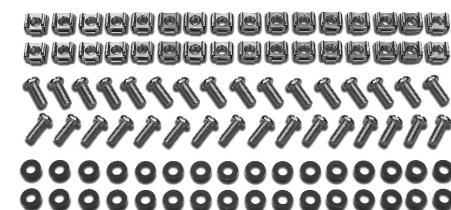

AR8100

# NetShelter Enclosures with Shock Packaging & Shock Pallet

## Rack & Stack made easy for equipment integrators

Secure shipping, fast deployment, and enhanced integrated solutions with APC enclosures with shock packaging and shock pallet. These solutions offer:

- Lower physical layer engineering and production costs
- Faster integration time of overall IT solution
- Reduction in physical layer floor space requirements during rack & stack
- Reduction in packaging and recycling of physical layer materials
- Certifications and reference designs with top IT manufacturers



### Includes:

- Shock pallet
- Cardboard outer wrap and foam
- Plastic covering to keep dust debris out
- Ramp
- Cabinets include heavy duty casters, fixed and swivel for maneuverability



## How does it work?



## Secure shipping and fast deployment with Cisco + Schneider Electric

Today's converged and hyperconverged infrastructures and off-premises data centers require fully populated IT cabinets to be more securely shipped to customer or colocation sites for fast, low-risk deployment. The loss of or damage to even a single rack can run up to a million dollars or more.

Schneider Electric delivers a Cisco-validated shipping solution that simplifies Cisco UCS "rack and stack" and protects IT equipment to lower costs, reduce risk, and provide speed and flexibility for deployment.





# NetShelter Enclosures with Shock Packaging & Shock Pallet

NetShelter SKU	U-space	Height	Width	Depth	Max mounting depth	Shipping load capacity	Packaged
<b>NetShelter SX</b>							
AR3003SP	12U	658mm (25.9 in.)	600mm (24 in.)	900mm (35.4 in.)	756mm (29.8 in.)	272kg (600 lb.)	Shock pallet, packaging, one-time use ramp
AR3006SP	18U	925mm (36.4 in.)	600mm (24 in.)	900mm (35.4 in.)	756mm (29.8 in.)	408kg (900 lb.)	Shock pallet, packaging, one-time use ramp
AR3103SP	12U	658mm (25.9 in.)	600mm (24 in.)	1070mm (42 in.)	921mm (36.3 in.)	272kg (600 lb.)	Shock pallet, packaging, one-time use ramp
AR3106SP	18U	925mm (36.4 in.)	600mm (24 in.)	1070mm (42 in.)	921mm (36.3 in.)	408kg (900 lb.)	Shock pallet, packaging, one-time use ramp
AR3104SP1	24U	1200mm (47 in.)	600mm (24 in.)	1070mm (42 in.)	915mm (36 in.)	907kg (2000 lb.)	Shock pallet, packaging, one-time use ramp
AR3100SP	42U	1991mm (78.4 in.)	600mm (24 in.)	1070mm (42 in.)	915mm (36 in.)	907kg (2000 lb.)	Shock pallet, packaging, one-time use ramp
AR3105SP	45U	2124mm (83 in.)	600mm (24 in.)	1070mm (42 in.)	915mm (36 in.)	907kg (2000 lb.)	Shock pallet, packaging, one-time use ramp
AR3107SP	48U	2258mm (88.9 in.)	600mm (24 in.)	1070mm (42 in.)	915mm (36 in.)	907kg (2000 lb.)	Shock pallet, packaging, one-time use ramp
AR3150SP	42U	1991mm (78.4 in.)	750mm (30 in.)	1070mm (42 in.)	915mm (36 in.)	907kg (2000 lb.)	Shock pallet, packaging, one-time use ramp
AR3155SP	45U	2124mm (83 in.)	750mm (30 in.)	1070mm (42 in.)	915mm (36 in.)	907kg (2000 lb.)	Shock pallet, packaging, one-time use ramp
AR3157SP	48U	2258mm (88.9 in.)	750mm (30 in.)	1070mm (42 in.)	915mm (36 in.)	907kg (2000 lb.)	Shock pallet, packaging, one-time use ramp
AR3300SP	42U	1991mm (78.4 in.)	600mm (24 in.)	1200mm (48 in.)	1048mm (41.3 in.)	907kg (2000 lb.)	Shock pallet, packaging, one-time use ramp
AR9300SP*	42U	1991mm (78.4 in.)	600mm (24 in.)	1200mm (48 in.)	1048mm (41.3 in.)	1587kg (3500 lb.)	Shock pallet & packaging
AR9300SP-R*	42U	1991mm (78.4 in.)	600mm (24 in.)	1200mm (48 in.)	1048mm (41.3 in.)	1587kg (3500 lb.)	Shock pallet, packaging, and reusable ramp
AR3305SP	45U	2124mm (83 in.)	600mm (24 in.)	1200mm (48 in.)	1048mm (41.3 in.)	907kg (2000 lb.)	Shock pallet, packaging, one-time use ramp
AR3307SP	48U	2258mm (88.9 in.)	600mm (24 in.)	1200mm (48 in.)	1048mm (41.3 in.)	907kg (2000 lb.)	Shock pallet, packaging, one-time use ramp
AR9307SP*	48U	2258mm (88.9 in.)	600mm (24 in.)	1200mm (48 in.)	1048mm (41.3 in.)	1587kg (3500 lb.)	Shock pallet & packaging
AR9307SP-R*	48U	2258mm (88.9 in.)	600mm (24 in.)	1200mm (48 in.)	1048mm (41.3 in.)	1587kg (3500 lb.)	Shock pallet, packaging, and reusable ramp
AR3350SP	42U	1991mm (78.4 in.)	750mm (30 in.)	1200mm (48 in.)	1048mm (41.3 in.)	907kg (2000 lb.)	Shock pallet, packaging, one-time use ramp
AR3355SP	45U	2124mm (83 in.)	750mm (30 in.)	1200mm (48 in.)	1048mm (41.3 in.)	907kg (2000 lb.)	Shock pallet, packaging, one-time use ramp
AR3357SP	48U	2258mm (88.9 in.)	750mm (30 in.)	1200mm (48 in.)	1048mm (41.3 in.)	907kg (2000 lb.)	Shock pallet, packaging, one-time use ramp
<b>NetShelter CX</b>							
AR4018SP	18U	1015mm (39 in.)	750mm (30 in.)	1130mm (44 in.)	880mm (34.6 in.)	317kg (700 lb.)	Shock pallet & packaging
AR4024SP	24U	1285mm (50 in.)	750mm (30 in.)	1130mm (44 in.)	880mm (34.6 in.)	363kg (800 lb.)	Shock pallet & packaging
<b>NetShelter Wall-mount</b>							
AR106V	6U	648mm (25.5 in.)	965mm (38 in.)	331mm (13 in.)	762mm (30 in.)	113kg (250 lb.)	Shock packaging
AR106VI	6U	648mm (25.5 in.)	965mm (38 in.)	331mm (13 in.)	762mm (30 in.)	113kg (250 lb.)	Shock packaging

\*For availability check [apc.com](http://apc.com) or request further details from your APC sales representative.

# Pre-integrate Your Rack Configurations

Now you can pre-integrate your rack in local Schneider Electric factories by using Local Edge Configurator for a speedy and hassle free deployment

Pre-integrated racks are assemble-to-order configurations for a speedy and hassle free deployment. They save time, money, and space for end users and system integrators receiving, deploying, and installing products and keep them focused on the IT rather than physical infrastructure.

Your selected rack and other equipment are assembled in one package before shipping from a Schneider Electric factory and are ready to use in your premises. These are ideal solutions for edge and IoT applications where deployment speed, reliability, and security is paramount.

Users can choose to pre-integrate any rack which has at least one piece of equipment in it to pre-integrate.

Pre-integration is limited to Schneider Electric products only and accomplished using Schneider Electric Design Portal Local Edge Configurator accessible by APC sales representatives and partners.

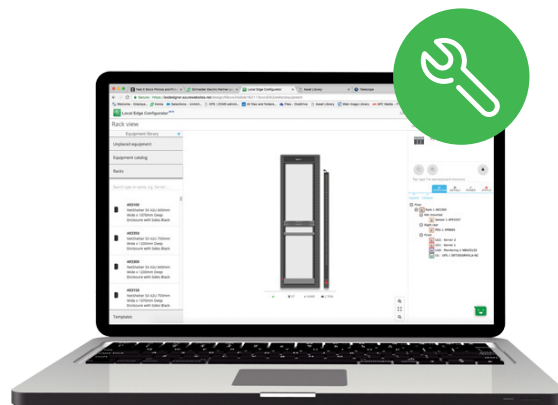

## Three steps to pre-integrate

- 1) Find and add rack and other required equipment into a Local Edge Configurator design.
  - 2) In rack view, drag and drop equipment into the rack.
  - 3) Select "Pre-integrate" from the additional features widget menu.
- Click on rack to view additional features widget
  - Click pre-integration button

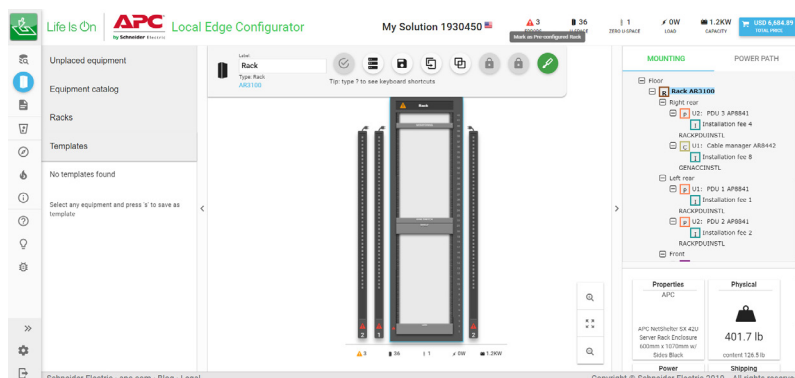

## Products eligible for pre-integration

- NetShelter SX, CX, and 6U Low-Profile Wall-mount Enclosure
- NetShelter rack accessories
- NetShelter Rack PDUs
- Smart-UPS
- NetBotz
- Racks with or without shock pallets for IT integration

Hear from one of our customers on how rack pre-integration sped up their deployment and time to market.

[Watch the video >](#)

Contact your APC sales representative or partner and ask them to integrate your next rack with Local Edge Configurator and NetShelter Racks and Enclosures and Accessories.





**Not a sales representative or registered partner?**

[Click here to find a partner now](#)



Want to be come a partner ? [Click here to register now](#)

# EcoStruxure™ Data Center Solutions

No matter how large or small your next IT deployment, Schneider Electric offers all-in-one critical infrastructure solutions for every environment.

EcoStruxure Micro Data Center	EcoStruxure Row Data Center	EcoStruxure Pod Data Center	EcoStruxure Modular Data Center
			
<p>Manageable, configurable, fast and flexible for IT deployments from the cloud to the edge</p>			
<p>Typical Deployment Size: 1 – 3 Micro Data Centers, 2 – 20 kW</p>	<p>Typical Deployment Size: 3 – 20 Racks, 10 – 100 kW</p>	<p>Typical Deployment Size: 8 – 60 racks in a single pod configuration</p>	<p>Typical Deployment Size: 5 – 24 racks (All-in-One) to 200+ (IT Hall)</p>

## Common attributes for EcoStruxure Data Center solutions

 <h3>Manageable</h3> <p>Schneider Electric has a range of management options to best meet your needs enabled by best-in-class management software and services.</p>	 <h3>Configurable</h3> <p>Pre-engineered system level designs supported by best-in-class design tools and primarily configured from standard components to increase reliability.</p>	 <h3>Fast</h3> <p>EcoStruxure Data Center solutions can be designed and deployed quickly leveraging our global supply chain to meet your delivery requirements.</p>	 <h3>Flexible</h3> <p>Designed with a modular approach that can be configured in a variety of form factors and sizes to adapt to a range of environments and applications.</p>
--	---	---	---

Learn more about EcoStruxure Data Center Solutions.

[Discover more >](#)





# Explore, select, and configure

## How to order?

- Contact your trusted partner OR
- Find a partner at [apc.com/howtobuy](https://apc.com/howtobuy)

## Why APC?

APC is known for its legendary reliability. This reliability is more critical than ever with the expansion of IoT and the growing reliance of businesses on data and connectivity. APC provides end-to-end solutions that ensure certainty in a connected world, as well as access to a strong ecosystem of partners and deployment resources around the globe. We are here to support you in making your next edge computing deployment simple, reliable and predictable in any environment.

## Resources:



Explore all of these products in 3D with SketchFab.

[Read more >](#)



Open the Rack PDU Selector.

[Read more >](#)



Configure your own Rack PDU.

[Read more >](#)



Learn how to choose IT Rack 201.

[Read more >](#)



How to Choose IT Rack Power Distribution 202.

[Read more >](#)

Life Is On



Explore APC Solutions at  
[apc.com](http://apc.com)

Schneider Electric  
One Boston Place  
Floor 27  
Boston, MA 02108  
United States  
[www.apc.com](http://www.apc.com)