



## Advanced User Guide



### Eaton 3P Ellipse

3P550F  
3P550D  
3P550I

3P700F  
3P700D  
3P700I  
3P700UF  
3P700UD  
3P700UI

3P900UF  
3P900UD  
3P900UI

3P1300UF  
3P1300UD  
3P1300UI

3P1700UF  
3P1700UD  
3P1700UI

## Table of Content

1	Special symbols .....	4
2	Introduction .....	5
2.1	Environmental protection .....	5
2.2	Benefits .....	6
3	Presentation .....	7
3.1	Product description .....	7
3.2	Optional accessories .....	7
4	Installation .....	8
4.1	Inspecting the equipment .....	8
4.2	Recommended positions.....	9
4.3	UPS connection.....	9
4.4	Register warranty .....	11
5	Interfaces and communication.....	12
5.1	User settings .....	12
5.2	Communication ports .....	14
5.3	Control panel.....	15
5.4	Cybersecurity .....	16
6	Operation.....	16
6.1	Start-up and normal operation .....	16
6.2	Return of AC input power.....	17
7	UPS maintenance.....	17
7.1	Equipment care .....	17
7.2	Storing the equipment.....	17
7.3	When to replace batteries .....	17
7.4	Replacing batteries.....	17
7.5	Recycling the used equipment.....	21
8	Troubleshooting.....	21
8.1	Service and support.....	22
9	Specification and technical characteristics.....	23
9.1	UPS model list.....	23
9.2	Dimensions and weight.....	23

9.3	Electrical input.....	24
9.4	Electrical input connections.....	25
9.5	Electrical output.....	26
9.6	Electrical output connection.....	26
9.7	Battery.....	27
9.8	Environmental and safety.....	27
10	Glossary .....	29

# 1 Special symbols

The following are examples of symbols used on the UPS or accessories to alert you to important information:



**DANGER:** Dangerous voltage levels are present within the UPS. The UPS has its own internal power source (the battery). Consequently, the power outlets may be energized even if the UPS is disconnected from the AC power source.



**CAUTION:** Batteries present a risk of energy or electrical shock or burn from high short circuit current. Observe proper precaution. Batteries may contain HIGH VOLTAGE and CORROSIVE, TOXIC and EXPLOSIVE substances.

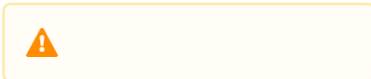

Important instructions that must always be followed.



Information, advice, help.



Read the documentation provided.



Disconnect input plug.



Before maintenance, first shut down the UPS then disconnect the AC power source, internal and external batteries then discharge capacitors by pressing the ON button and wait 5 minutes.



This equipment should only be used in a dry indoor environment.



Operating range of temperature.



Operating range of humidity.



The UPS and their batteries must be kept in a ventilated place.



Battery + Surge Outlet: This outlet offers protection against power supply outages and overvoltage surges.



Surge Outlet: This outlet specifically guards against overvoltage surges.



USB Communication Port



USB Power Port: The USB port is designed for recharging devices, with the maximum current shared between the two ports.



Alternating Current (AC)



Direct Current (DC)

## 2 Introduction

Thank you for selecting an Eaton 3P Ellipse product to protect your electrical equipment.

The Eaton 3P Ellipse range has been designed with the utmost care. We recommend that you take the time to read this advanced user guide to take full advantage of the many features of your UPS (Uninterruptible Power System).

Before installing your Eaton 3P Ellipse, please read the information and safety instructions provided. Follow the instructions in the quick start guide and if necessary, refer to this advance user guide.

To discover the entire range of Eaton products, we invite you to visit our web site at [eaton.com](http://eaton.com) or contact your Eaton local representative.

The Eaton 3P Ellipse Uninterruptible Power System (UPS) is designed for computers and their peripherals, NAS, televisions, internet gateways, etc... It must not be used to supply other electrical equipment (lighting, heating, household appliances, etc.). It prevents your critical equipment from power problems such as power failures and power surges.

### 2.1 Environmental protection

Eaton has implemented an environmental-protection policy. Products are developed according to an eco-design approach.

#### Substances

This product contains no CFC, HCFC or asbestos. This product is compliant with regulations on the restriction of the use of substances in electrical and electronic equipment.

#### Packaging

To improve waste treatment and facilitate recycling, separate the various packing components. Follow local regulations for the disposal of packing materials.

- Packing materials are recyclable and bear the appropriate identification symbol  .
- The cardboard we use comprises over 50% of recycled cardboard.
- Plastic bags are made of polyethylene

Materials	Abbreviations	Number in the symbols
Polyethylene terephthalate	PET	01
High-density polyethylene	HDPE	02
Polyvinyl chloride	PVC	03
Low-density polyethylene	LDPE	04
Polypropylene	PP	05
Polystyrene	PS	06

#### End of life

Eaton will process products at the end of their service life in compliance with local regulations. Eaton works with companies in charge of collecting and eliminating our products at the end of their service life.

#### Product

The product is made from materials that can be recycled. Dismantling and destruction must take place in compliance with all local regulations concerning waste. At the end of its service life, the product must be transported to a processing center for electrical and electronic waste. [eaton.com/recycling](http://eaton.com/recycling)

## Battery

The product contains lead-acid batteries that must be processed according to applicable local regulations concerning batteries. The battery may be removed to comply with regulations and in view of correct disposal.

## 2.2 Benefits

The Eaton 3P Ellipse uninterruptible power system (UPS) protects your sensitive electronic equipment from the most common power problems, including power outages, voltage sags, impulsive transients.

Power outages can occur when you least expect it and power quality can be erratic. These power problems have the potential to corrupt critical data, destroy unsaved work sessions, and damage hardware - causing hours of lost productivity and expensive repairs.

With the Eaton 3P Ellipse, you can safely eliminate the effects of power disturbances and guard the integrity of your equipment. Providing outstanding performance and reliability, the Eaton's unique benefits include:

- Backed by worldwide agency approvals.
- Surge protection – compliant with IEC 61643-11 Standard.
- Slim line & versatile form factor.
- USB Type C + USB Type A charger ports on communication models.
- Optional connectivity cards with enhanced communication capabilities.

# 3 Presentation

## 3.1 Product description

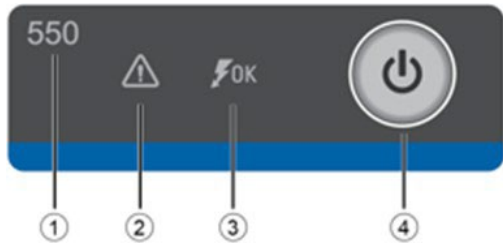

- ① Model
- ② Fault status LED
- ③ Surge protection status LED
- ④ ON/OFF Button



- ⑤ UPS
- ⑥ AC Input
- ⑦ Breaker
- ⑧ AC Output (battery + surge protection)
- ⑧' AC Output (surge protection only)



- ⑨ USB charging ports (USB models only)
- ⑩ USB communication port (USB model only)
- ⑪ Pico-slot (optional, on USB models only)

## 3.2 Optional accessories

### CLOUD-PS

#### Eaton Picoslot Cloud Card

Slotable connectivity card for small UPS. Allows to connect the UPS to Brightlayer Remote Monitoring cloud application.

### ELRACK

**Rack mounting kit** – Allows to install Eaton 3P Ellipse in a 19' rack.

### ELWALL

**Wall mounting kit** – Allows to mount Eaton 3P Ellipse vertically on a wall or on the side of a cabinet.

# 4 Installation

## 4.1 Inspecting the equipment

If any equipment has been damaged during shipment, keep the shipping cartons and packing materials for the carrier or place of purchase and file a claim for shipping damage. If you discover damage after acceptance, file a claim for concealed damage.

To file a claim for shipping damage or concealed damage:

1. File with the carrier within 15 days of receipt of the equipment
2. Send a copy of the damage claim within 15 days to your service representative

**i** Check the battery recharge date on the shipping carton label. If the date has passed and the batteries were never recharged, do not use the UPS. Contact your local service representative.

### Package content

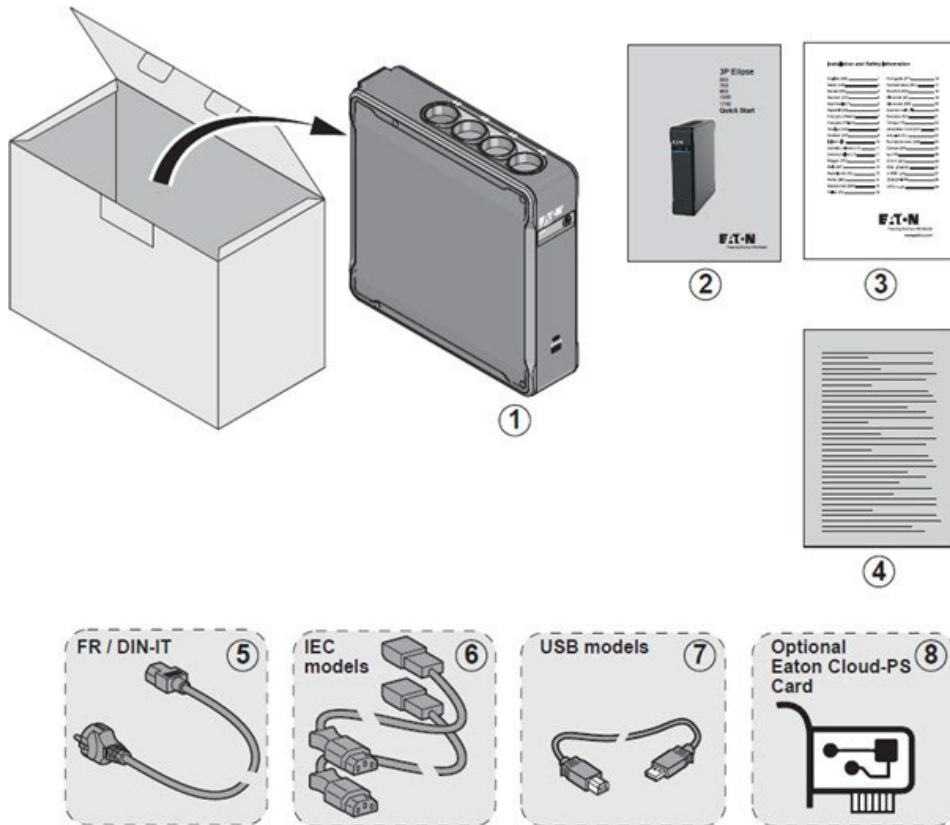

Verify that the following additional items are included with the UPS:

- ① UPS
- ② Quick start
- ③ Instructions and Safety Information
- ④ Warranty card
- ⑤ 1 Schuko input cable (FR & DIN models) / KC power cord set is not shipped with UPS
- ⑥ 2 IEC output cables (IEC models)
- ⑦ 1 USB communication cable (USB models)
- ⑧ Cloud card (optional on USB models)



## 4.2 Recommended positions

Place the Eaton 3P Ellipse on a flat, stable surface in its final location.

The UPS can be installed vertically, horizontally, or placed in rack 2U (optional kit). In both cases, you must check that the UPS is in the upright direction (EATON logo readable).

Horizontally, the Eaton 3P Ellipse can be positioned under an object, provided that the object does not weigh more than 10kg (22 lbs.), does not heat, and that the room temperature does not exceed 30°C.

*Remark: 2 UPS cannot be put on top of one another or side by side.*

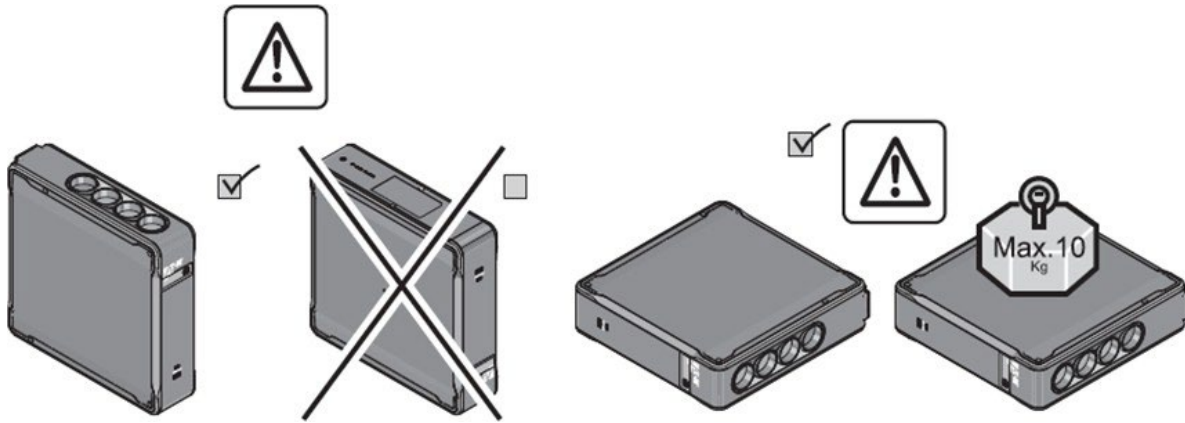

## 4.3 UPS connection

### Power supply connection

**⚠** Check that the indications on the name plate located on the back of the UPS correspond to the AC-power source and the true electrical consumption of the total load.

The socket-outlet shall be installed near the equipment and shall be easily accessible.

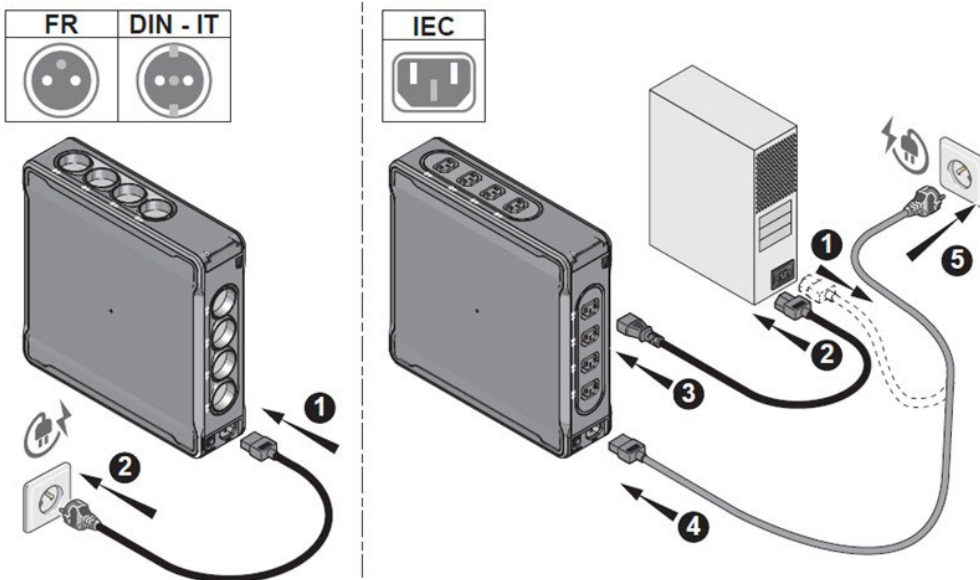

Connect the UPS to the AC-power system via a wall outlet with an earth connector, using the supplied cord for a UPS with FR or DIN-IT sockets or with the supply cord of your computer for a UPS with IEC sockets.

## Protected outlets / Backup & Protected outlets

Plug critical equipment (computer, monitor, modem, etc.) to the backup & protected outlets providing battery backup power and surge protection, taking care not to exceed the rated current indicated in amperes. Other devices (printer, scanner, fax, etc.) can be connected to the protected outlets that provide surge protection only. The protected outlets are not backed up by battery power in the event of a power outage. Equipment connected to these outlets is supplied as soon as the AC cord is plugged in. These are not affected by ON/OFF button.

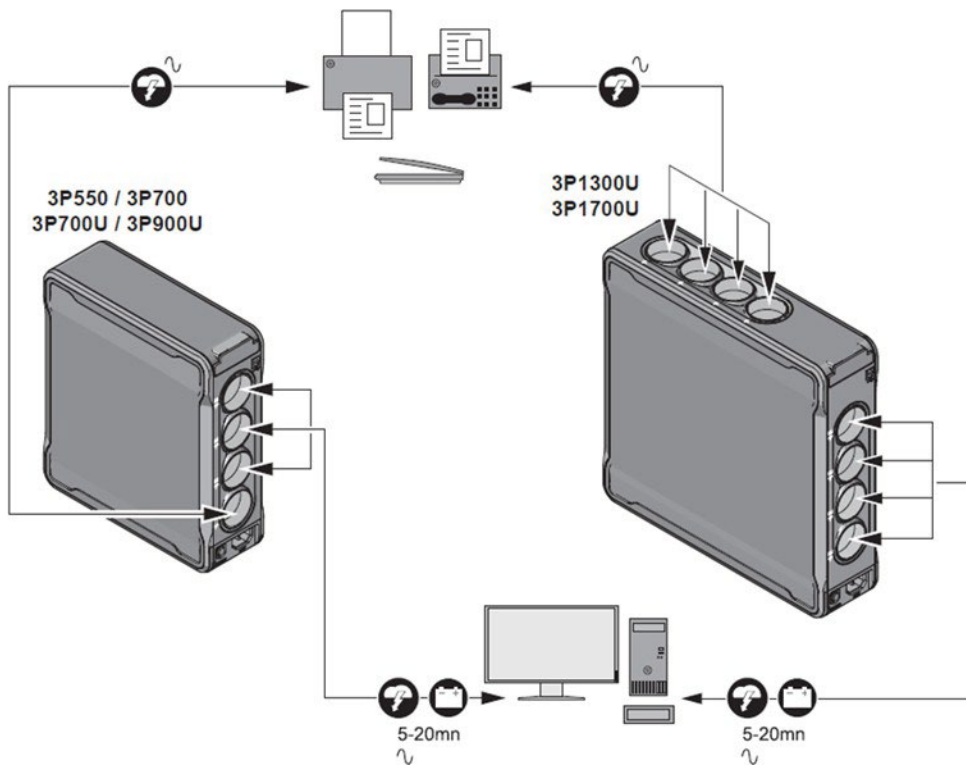

## USB charging port

USB models only: Connect your device to the USB charging ports, 1 USB A, 1 USB C (5V – 2.0 A maximum).

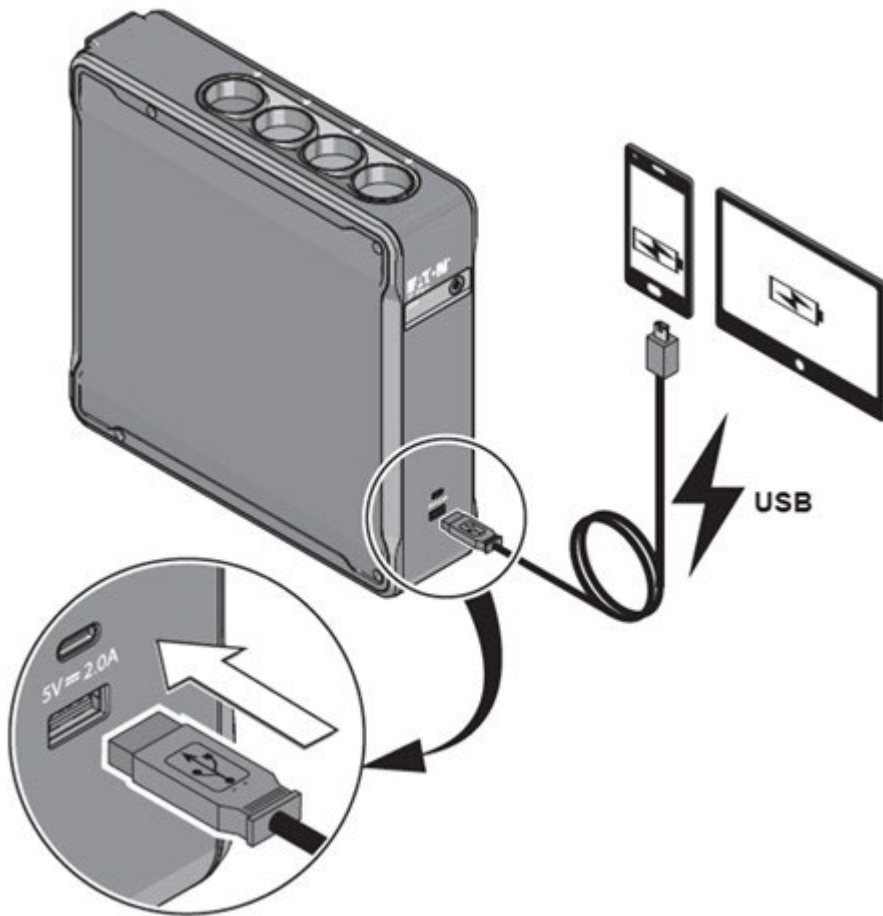

## 4.4 Register warranty

Register warranty at <https://www.pqproductregistration.eaton.com>

# 5 Interfaces and communication

## 5.1 User settings

The following table displays the options that can be changed by the user.

**Only to be used if frequent switching to the UPS battery due to large variations in the AC supply voltage.**

- Accessing the programming mode: with the device switched off but plugged in (all buttons are off, except ③), press button ④ for 6 sec. and release it once LEDs ④ & ② have come on, flashing.

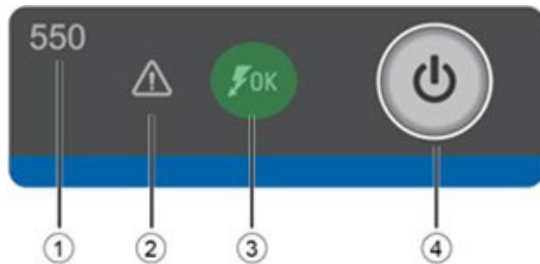

- Change from one mode to another by successively pressing button ④ for 2 sec.
- Display of the 3 possible voltage ranges according to the status of LEDs ④ & ②:
  - o Normal mode (factory configuration): AC supply between 184V and 264V – LEDs ② = ON, FLASHING & ④ = ON, FLASHING

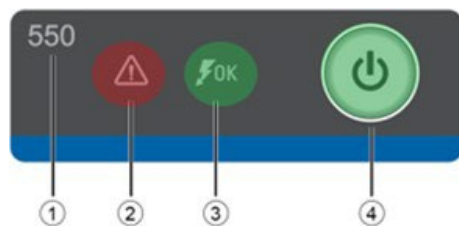

- o Low range mode: AC supply between 161V and 264V – LEDs ② = ON & ④ = OFF

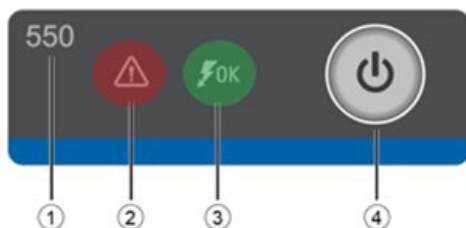

- o Low and high range mode: AC supply between 161V et 284V – LEDs ② = OFF & ④ = ON

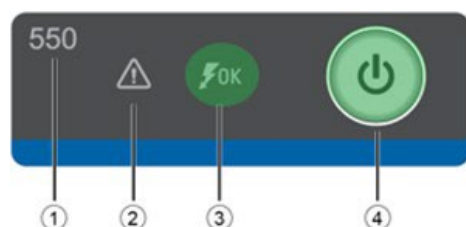

- Memorizing the mode: 10 sec. after the last press of the button.

Sensitivity to variations of the AC power supply

Through the programming mode, it is possible to choose to activate or deactivate the audio alarm of the UPS.

- Accessing the programming mode: with the device switched off but plugged in (all buttons are off, except ③), press button ④ for 11 sec. and release it when the audio alarm sounds.

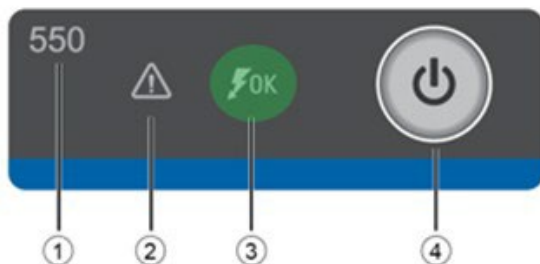

- Display of the 2 possible audio alarm modes:

#### Audible alarm

- o **Normal mode (factory configuration):** the UPS emits a beep every 5 sec. when operating on its battery.
- o **Silent mode:** the UPS emits a single beep when switching to battery operation and then remains silent.

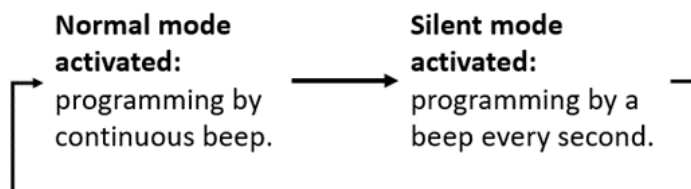

- Change from one mode to another by successively pressing button ④.
- Memorizing the mode: 10 sec. after the last press of the button.

*Note: it is not possible to silence the alarm while the UPS is in on battery mode.*

*Note: Audible mode setting can be performed through Eaton UPS Companion software for USB models.*

## 5.2 Communication ports

### USB Communication port

Connect the UPS to the computer using the USB cable.

Enhance your purchase by downloading the Eaton UPS Companion software using URL: [eaton.com/downloads](http://eaton.com/downloads)

**i** The UPS can now communicate with the power management software.

You can improve the remote monitoring and power management of the UPS by adding a CLOUD-PS card compatible with your product.

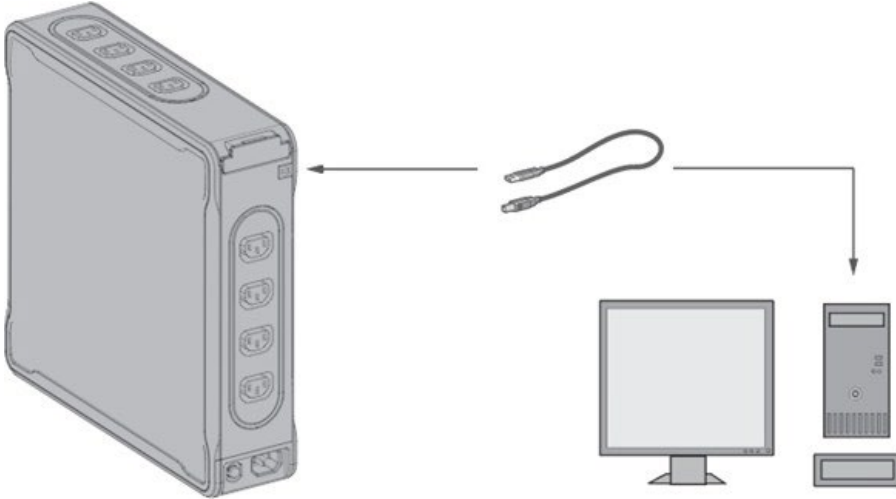

### Eaton Picoslot Cloud Card

Connectivity cards allow the UPS to communicate in a variety of networking environments and with different types of devices. The Eaton 3P Ellipse communication models are compatible with the Cloud communication card that allows to:

- Expose UPS data and status on Remote Monitoring cloud application
- Network settings configuration
- Card logs download
- Card FW upgrade
- UPS FW upgrade
- UPS settings configuration through Remote Monitoring application

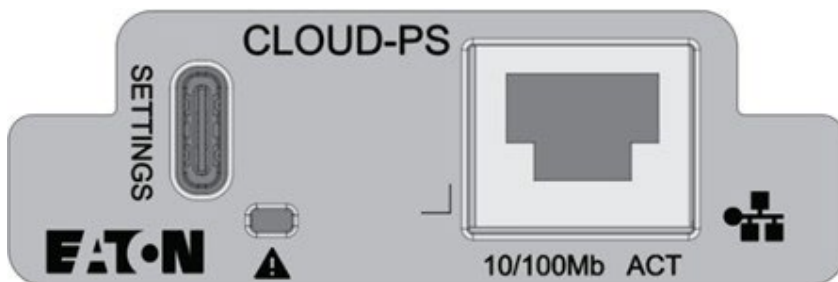

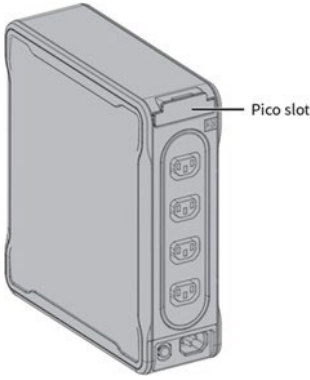

**i** It is not necessary to shut down the UPS before installing a communication card.

1. Remove the slot cover (using a small flat screwdriver if necessary).
2. Insert the communication card in the slot.
3. Clip it back in.

### 5.3 Control panel



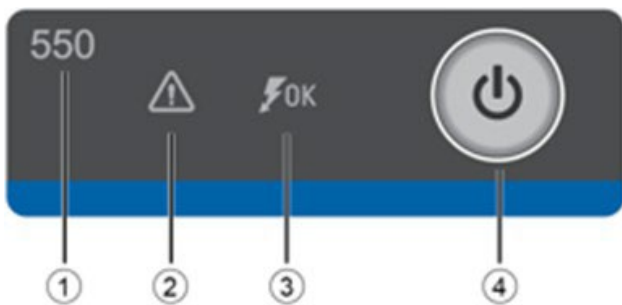

The status LED provides useful information about the UPS behavior.



- ① Model
- ② Fault status LED
- ③ Surge protection status LED
- ④ ON/OFF Button

#### Led indicator

The following table shows the indicator status and description:

Indicator	Status	Description
 Green	On	The UPS is "ON" and the load is protected.
 Green	Flashes	The UPS operates on battery power.
 Green	On	The surge protection is "ON" and the outlets are protected.
 Red	On	Battery fault / UPS fault. See troubleshooting page for additional information.

## 5.4 Cybersecurity

Eaton is committed to minimizing the Cybersecurity risk in its products and employs cybersecurity best practices and the latest cybersecurity technologies in its products and solutions, making them more secure, reliable and competitive for our customers. Eaton also offers Cybersecurity Best Practices whitepapers to its customers, referenced at [www.eaton.com/cybersecurity](http://www.eaton.com/cybersecurity).

## 6 Operation

### 6.1 Start-up and normal operation

**⚠** Check that the indications on the name plate located on the back of the UPS meets to the AC power source and the true electrical consumption of the total load.

#### Battery charge

The UPS charges the battery as soon as it is connected to the AC outlet, whether the ON/OFF button is pressed or not. It is recommended that the UPS be permanently connected to the AC power supply to ensure the best possible autonomy. When used for the first time, the battery will provide its maximum autonomy after it has been charged for eight hours.

#### To start the UPS

1. Verify that the UPS power cord is plugged
2. Switch on the UPS by pressing ON/OFF button during some second.
3. Verify that the  indicator illuminates solid, indicating that the UPS is operating normally and any loads are powered and protected. The UPS should be in Normal mode.

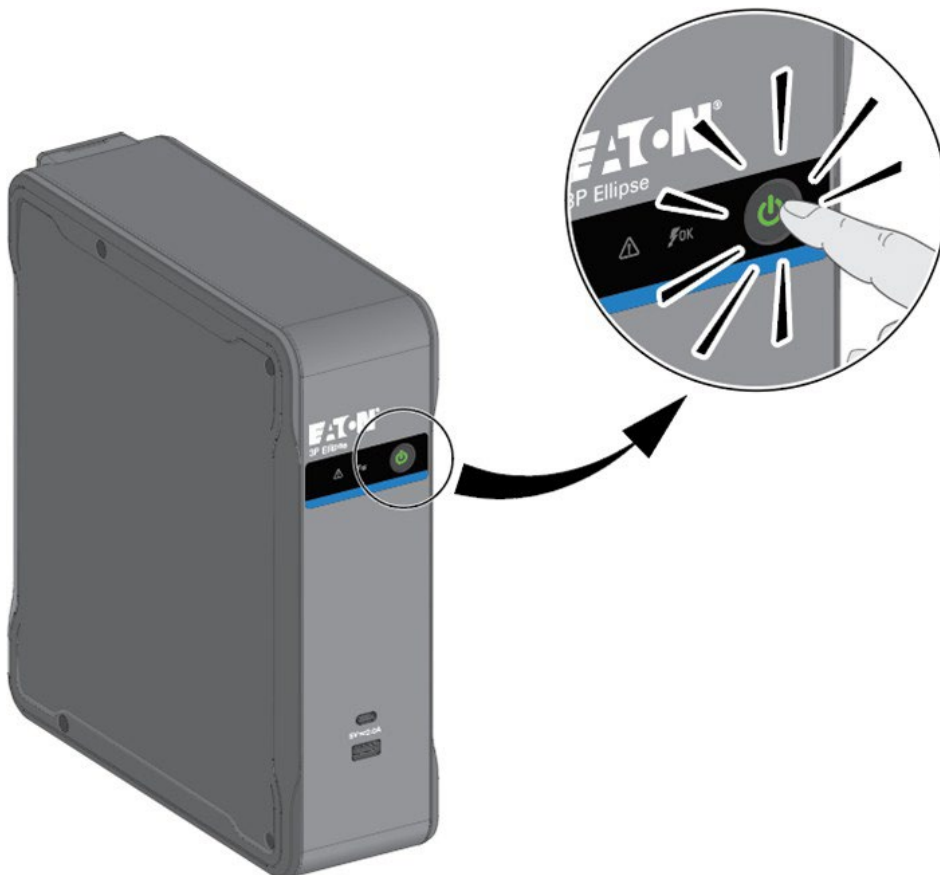



## Surge Protected outlets

All surge protected outlets provide power surges protection, whatever the position of ON/OFF button. The surge protection LED provides the status of the protection. When the surge protection LED is OFF your protection is defective, please contact after sales services or local representative.

## AC-power disturbance

If AC power is disturbed or fails, the UPS continues to operate on battery power. UPS power button flashes green. In battery mode, the audio alarm beeps every five seconds, then every two seconds when the end of battery backup time is near.

If the power outage lasts longer than the battery backup time, the UPS shuts down and automatically restarts when power is restored. Following a complete discharge, at least 48 hours are recommended to recharge the battery back to full backup time.

## 6.2 Return of AC input power

Following an outage, the UPS restarts automatically when AC input power returns and the load is supplied again.

# 7 UPS maintenance

## 7.1 Equipment care

For full battery life, keep the equipment at an ambient temperature of 25 °C (77 °F).

The batteries are rated for a 3-5 years service life. The length of service life varies, depending on the frequency of usage and ambient temperature (life divided by 2 each 10 °C above 25 °C).

If the UPS requires any type of transportation, verify that the UPS is turned off.

Batteries used beyond expected service life will often have severely reduced runtimes. Replace batteries at least every 4 years to keep units running at peak performance.

Batteries runtime will be reduced at low temperature (below 10 °C).

## 7.2 Storing the equipment

If you store the equipment for a long period, recharge the battery every 6 months by connecting the UPS to utility power. The internal batteries charge to 90% capacity in less than 3 hours. However, Eaton recommends that the batteries charge for 48 hours after long-term storage.

Check the battery recharge date on the shipping carton label. If the date has passed and the batteries were never recharged, do not use them. Contact your service representative.

## 7.3 When to replace batteries

Batteries have an expected life span of 3-5 years, after that period you should take proactive steps to ensure batteries replacement for optimal operation and reliability, contact your service representative to order new batteries.

## 7.4 Replacing batteries

For battery replacement, follow instructions provided on Eaton webpage: [www.eaton.eu/BatteryServices](http://www.eaton.eu/BatteryServices) .

Servicing of batteries can be performed by **an ordinary person** -only when the following instructions are understood and respected.

 Take care not to reverse the polarity + (red) and - (black) when connecting the batteries as this will destroy the device.

 DO NOT DISCONNECT the batterie while the UPS is in Battery mode.

 **Risk of Electric Shock:** Switch off and disconnect the UPS from the mains before proceeding to battery replacement.

Consider all warnings, cautions, and notes before replacing batteries.

- Replace with the same type and number of batteries or battery packs. Contact your service representative to order new batteries.
- Batteries can present a risk of electrical shock or burn from high short circuit current.
- Do not wear any metal objects including watches and rings.
- Do not lay tools or metal parts on top of batteries.
- Proper disposal of batteries is required. Refer to your local codes for disposal requirements.
- Do not dispose of batteries in a fire. When exposed to flame, batteries may explode.
- Do not open or mutilate the battery or batteries. Released electrolyte is harmful to the skin and eyes and may be extremely toxic.
- Determine if the battery is inadvertently grounded. If inadvertently grounded, remove source from ground. Contact with any part of a grounded battery can result in electrical shock. The likelihood of such shock can be reduced if such grounds are removed during installation and maintenance (applicable to equipment and remote battery supplies not having a grounded supply circuit).
- ELECTRIC ENERGY HAZARD. Do not attempt to alter any battery wiring or connectors. Attempting to alter wiring can cause injury.
- Failed batteries can reach temperatures that exceed the burn thresholds for touchable surfaces.

**Battery replacement for 3P550, 3P700, 3P900:**

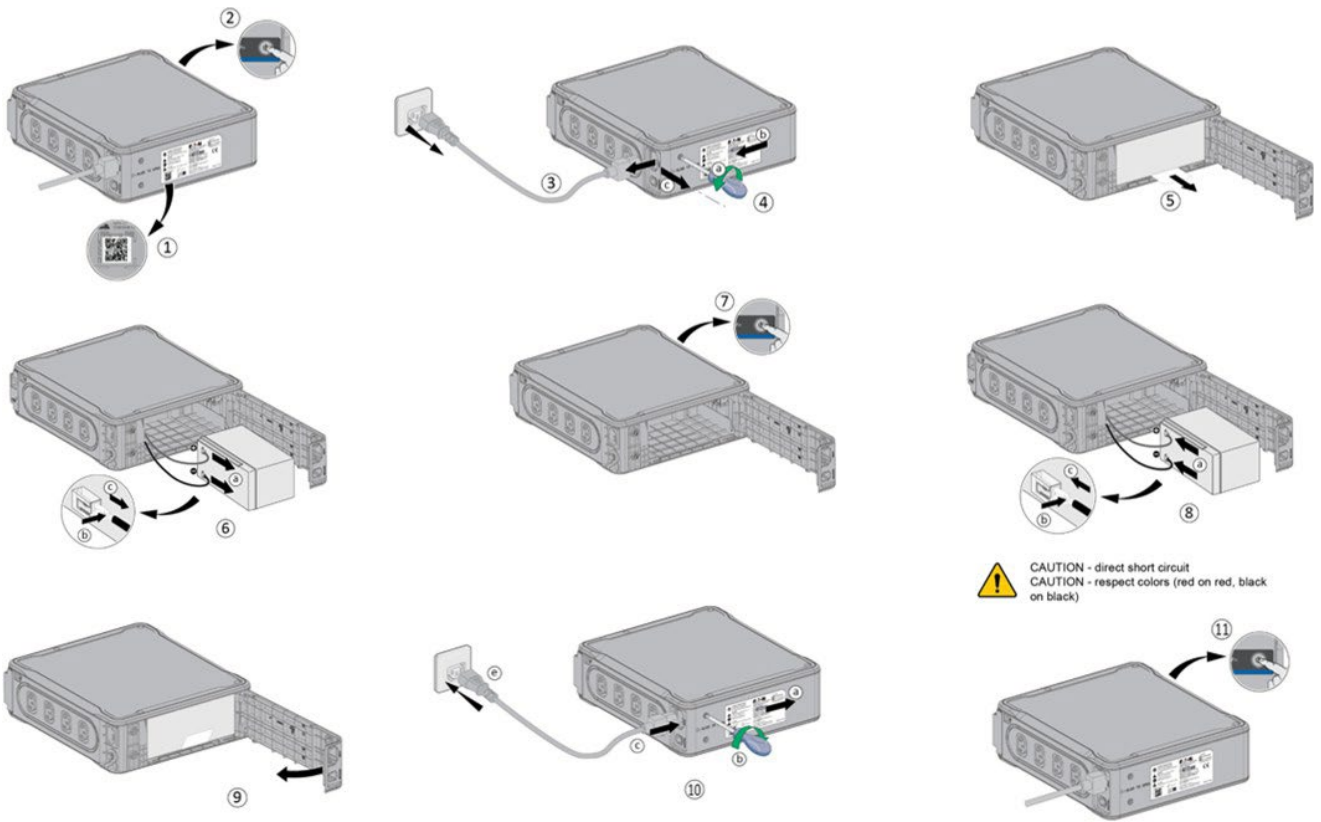

- Step 1: Scan QR Code and read battery replacement instruction
- Step 2: Switch Off the UPS
- Step 3: Disconnect the UPS from the main power
- Step 4: Open the battery door: remove screws with Phillips screwdriver (not provided) and slide to open
- Step 5: Use white plastic strip to pull out battery
- Step 6: Disconnect the battery terminals (red wire first) – Press the small clips (b) to unlock wires

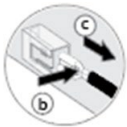

- Step 7: Press ON button to discharge residual energy
- Step 8: Replace the batteries (you can restick the white plastic strip with battery info on new batteries) – CAUTION direct short circuit – CAUTION respect colors (red on red, black on black)
- Step 9: Close battery door, slide it back to its original place and put screws back on with Phillips screwdriver (not provided)
- Step 10: connect the UPS to main power
- Step 11: Switch ON the UPS

**Battery replacement for 3P1300, 3P1700**

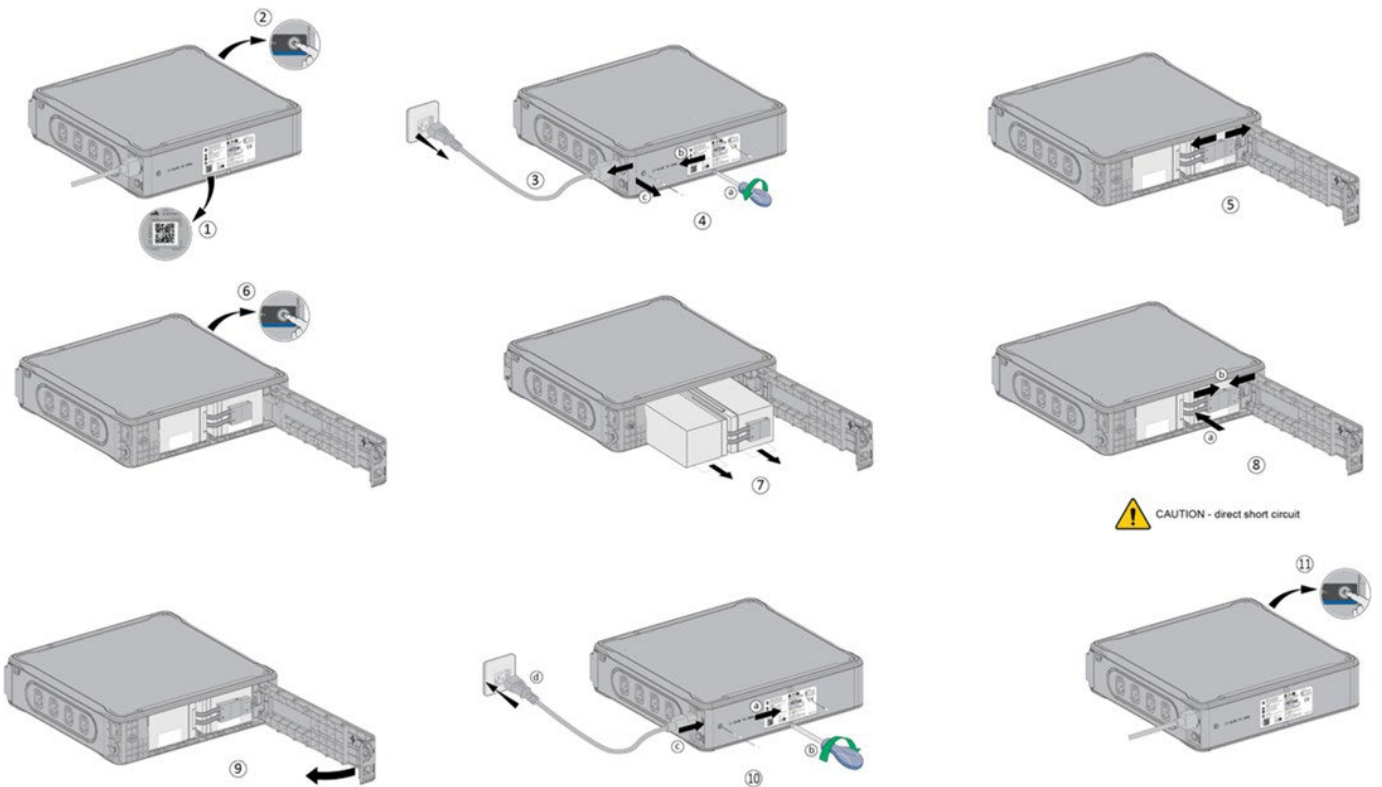

- Step 1: Scan QR Code and read battery replacement instruction
- Step 2: Switch Off the UPS
- Step 3: Disconnect the UPS from the main power
- Step 4: Open the battery door: remove screws with Phillips screwdriver (not provided) and slide to open
- Step 5: Disconnect the battery connector
- Step 6: Press ON button to discharge residual energy
- Step 7: Use white plastic strip to pull out batteries
- Step 8: Replace the batteries and reconnect battery connector – CAUTION direct short circuit
- Step 9: Close battery door, slide it back to its original place and put screws back on with Phillips screwdriver (not provided)
- Step 10: Connect the UPS to main power
- Step 11: Switch ON the UPS

## 7.5 Recycling the used equipment

Contact your local recycling or waste center for information on proper disposal of the used equipment. [eaton.com/recycling](http://eaton.com/recycling).



Do not dispose the battery or batteries in a fire, they may explode. Proper disposal of batteries is required, refer to your local codes for disposal requirements.

Do not open or mutilate the battery or batteries, released electrolyte is harmful to the skin and eyes. It may be toxic.



Pb

Do not discard the UPS or the UPS batteries in the trash. This product contains sealed, lead acid batteries and must be disposed of properly. For more information, contact your local recycling/reuse or hazardous waste center.



Do not discard waste electrical or electronic equipment (WEEE) in the trash. For proper disposal, contact your local recycling/reuse or hazardous waste center.

## 8 Troubleshooting

The Eaton 3P Ellipse is designed for durable, automatic operation and alerts you whenever potential operating problem may occur.

Usually the alarms shown by the product do not mean that the output power is affected. Instead, they are preventive alarms intended to alert the user.

- Some alarms may be announced by a beep in a regular Example = "Battery low".
- Faults are announced by a continuous beep and red LED.

Use the following troubleshooting chart to determine the UPS alarm condition.

Conditions	Possible cause	Action
The battery backup outlets ⑧ are not supplied with power.	Button ④ is not lighted on.	Press button ④ and check that it turns green.
The connected devices are not supplied when AC power fails.	The devices are not connected to the battery backup outlets ⑧.	Connect the devices to the battery backup outlets ⑧.
AC power is available, but the UPS operates on battery power.	Circuit breaker ⑦ located under the UPS has been tripped by an overload on the UPS output.	Disconnect excess equipment and reset the circuit breaker ⑦ by pressing the corresponding button.
The filtered outlets ⑧' are not supplied.	- The wall outlet is not supplied. - Circuit breaker ⑦, located under the UPS, has been tripped by an overload on the UPS output.	- Supply power to the wall outlet. - Disconnect excess equipment and reset the circuit breaker ⑦ by pressing the corresponding button.
Green button ④ flashes frequently and audio alarm beeps.	The UPS frequently operates on battery power because the AC power source is of poor quality.	Have the electrical installation checked by a professional or use another wall outlet.

Conditions	Possible cause	Action
Green button ④ flashes and audio alarm beeps continuously.	The UPS battery backup outlets ⑧ are overloaded.	Disconnect excess equipment connected to the battery backup outlets ⑧.
Red LED ② is on and the audio alarm beeps.	A fault has occurred on the UPS. The battery backup outlets ⑧ are no longer supplied.	Call after-sales support.
Green light ③ is off and the filtered outlets are supplied.	Surge protection is no longer provided	Call after-sales support.
Red LED ② flashes.	The battery has reached the end of its service life.	Have the battery replaced.
AC power is available, but the UPS does not switch on when pressing button ④	The battery has reached the end of its service life.	Have the battery replaced.

## 8.1 Service and support

If you have any question or problem with the UPS, call Eaton or your local service representative in your country / region. Please have the following information ready when you call for service:

- Model number
- Serial number
- Firmware version number
- Date of failure or problem
- Symptoms of failure or problem
- Customer return address and contact information

If repair is required, you will be given a Returned Material Authorization (RMA) number. This number must appear on the outside of the package and on the Bill Of Lading (if applicable). Use the original packaging or request packaging from the Help Desk or distributor. Units damaged in shipment as a result of improper packaging are not covered by warranty. A replacement or repair unit will be shipped freight prepaid for all warrantied units.

 For critical applications, immediate replacement may be available. Call the Help Desk for the dealer or distributor nearest you.

## 9 Specification and technical characteristics

### 9.1 UPS model list

Description	Catalog Number	Power rating	Configuration
Eaton Ellipse 3P 550 FR	3P550F	330W / 550VA	Tower
Eaton Ellipse 3P 550 DIN	3P550D	330W / 550VA	Tower
Eaton Ellipse 3P 550 IEC	3P550I	330W / 550VA	Tower
Eaton Ellipse 3P 700 FR	3P700F	420W / 700VA	Tower
Eaton Ellipse 3P 700 DIN	3P700D	420W / 700VA	Tower
Eaton Ellipse 3P 700 IEC	3P700I	420W / 700VA	Tower
Eaton Ellipse 3P 700 USB FR	3P700UF	420W / 700VA	Tower
Eaton Ellipse 3P 700 USB DIN	3P700UD	420W / 700VA	Tower
Eaton Ellipse 3P 700 USB IEC	3P700UI	420W / 700VA	Tower
Eaton Ellipse 3P 900 USB FR	3P900UF	540W / 900VA	Tower
Eaton Ellipse 3P 900 USB DIN	3P900UD	540W / 900VA	Tower
Eaton Ellipse 3P 900 USB IEC	3P900UI	540W / 900VA	Tower
Eaton Ellipse 3P 1300 USB FR	3P1300UF	840W/1300VA	Tower
Eaton Ellipse 3P 1300 USB DIN	3P1300UD	840W/1300VA	Tower
Eaton Ellipse 3P 1300 USB IEC	3P1300UI	840W/1300VA	Tower
Eaton Ellipse 3P 1700 USB FR	3P1700UF	1040W/1700VA	Tower
Eaton Ellipse 3P 1700 USB DIN	3P1700UD	1040W/1700VA	Tower
Eaton Ellipse 3P 1700 USB IEC	3P1700UI	1040W/1700VA	Tower

### 9.2 Dimensions and weight

Description (UPS)	Weights (kg / lbs.)	Dimensions (mm / inch) D x W x H
3P550F 3P550D 3P550I	3.3 / 7.3	235 x 81 x 263 / 9.3 x 3.2 x 10.4

Description (UPS)	Weights (kg / lbs.)	Dimensions (mm / inch) D x W x H
3P700F 3P700D 3P700I	3.9 / 8.6	235 x 81 x 263 / 9.3 x 3.2 x 10.4
3P700UF 3P700UD 3P700UI 3P900UF 3P900UD 3P900UI	4.1 / 9.0	235 x 81 x 263 / 9.3 x 3.2 x 10.4
3P1300UF 3P1300UD 3P1300UI 3P1700UF 3P1700UD 3P1700UI	7.7 / 16.9	312 x 81 x 305 / 12.3 x 3.2 x 12

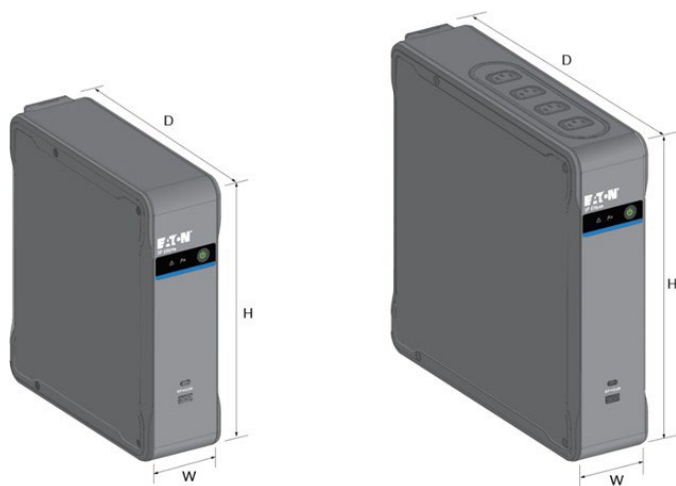

### 9.3 Electrical input

<b>Default frequency</b>	50Hz
<b>Nominal frequency</b>	50/60Hz
<b>Frequency range</b>	47-70Hz
<b>Protective class</b>	Protective class I



Catalog Number	Default input (Voltage/Current)	Input nominal voltages	Input voltage window
3P550F 3P550D 3P550I	230V/10A MAX	220V, <b>230V</b> , 240V	Normal mode:184V-264V Expanded mode: 161V-284V
3P700F 3P700D 3P700I 3P700UF 3P700UD 3P700UI	230V/10A MAX		Normal mode:184V-264V Expanded mode: 161V-284V
3P900UF 3P900UFC 3P900UD 3P900UDC 3P900UI	230V/10A MAX		Normal mode:184V-264V Expanded mode: 161V-284V
3P1300UF 3P1300UD 3P1300UI	230V/10A MAX		Normal mode:184V-264V Expanded mode: 161V-284V
3P1700UF 3P1700UFC 3P1700UD 3P1700UDC 3P1700UI	230V/10A MAX		Normal mode:184V-264V Expanded mode: 161V-284V

## 9.4 Electrical input connections

Catalog Number	Input connection	Input cable
3P550I 3P700I 3P700UI 3P900UI 3P1300UI 3P1700UI	IEC C14-10A	Not provided
3P550F 3P550D 3P700F 3P700D 3P700UF 3P700UD 3P900UF 3P900UD 3P1300UF 3P1300UD 3P1700UF 3P1700UD	Input cord with Schuko plug	1.7m Schuko cable provided

## 9.5 Electrical output

All models	Normal mode	Battery mode
Voltage regulation	Follow input voltage	+15% / -20%
Efficiency	>98%	Between 75% and 84%
Frequency regulation	Same as input	±1 Hz
Nominal output	220/230/240V	
Nominal Frequency	50Hz or 60Hz, autosensing	
Output overload	[105-120%*] 300 sec [120-150%] 10 sec >150% 1s	105%-110% 10s >110% 1s
Short circuit current limitation	Depend on the external fuse or breaker in the upstream of UPS	550 models: max RMS & delay time: 8.09A/19ms; The max peak value: 19A 700 USB models (cover 700 models): max RMS & delay time: 9A/19ms; The max peak value: 19A 900 models: max RMS & delay time: 12.9A/19ms; The max peak value: 32A 1300 models: max RMS & delay time: 21.5A/19ms; The max peak value: 62A 1700 models: max RMS & delay time: 21.6A/19ms; The max peak value: 68A
Voltage waveform	step wave	
Harmonic distortion	same as mains	<40%
Power Factor	550VA, 700VA, 900VA: 0.6 1300VA: 0.646 1700VA: 0.611	

## 9.6 Electrical output connection

Catalog Number	Output connection	Output cable
3P700I 3P700UI 3P900UI 3P1300UI 3P1700UI	IEC- 10A	2 IEC 10A

Catalog Number	Output connection	Output cable
3P550F 3P700F 3P700UF 3P900UF 3P900UFC 3P1300UF 3P1700UF 3P1700UFC	FR 10A	Not provided
3P550D 3P700D 3P700UD 3P900UD 3P900UDC 3P1300UD 3P1700UD 3P1700UDC	DIN-IT 10A	Not provided

## 9.7 Battery

	Internal batteries
<b>Specifications</b>	550VA: 12Vdc – 1 x 12V, 4.5Ah 700VA: 12Vdc – 1 x 12V, 7Ah 900VA: 12Vdc – 1 x 12V, 9Ah 1300VA: 24Vdc – 2 x 12V, 7Ah 1700VA: 24Vdc – 2 x 12V, 9Ah  Brand & Reference: LEOCH/DJW12-XX or equivalent
<b>Type</b>	Valve Regulated Lead-Acid (VRLA) Sealed, maintenance-free, minimum 3-5 years float service life at 25°C (77°F)

## 9.8 Environmental and safety

<b>Standards</b>	IEC/EN 62040-1 Safety IEC/EN 62040-2 Electromagnetic Compatibility IEC/EN 62040-3 Performance
<b>EMC (Emissions)</b>	CISPR32 Class B IEC/EN 61000-3-2 Harmonics IEC/EN 61000-3-3 Flickers EN IEC 62040-2

<b>EMC (Immunity)</b>	IEC 61000-4-2, (ESD): 8 kV Contact Discharge / 15 kV Air Discharge IEC 61000-4-3, (Radiated field): 10 V/m IEC 61000-4-4, (EFT): 4 kV IEC 61000-4-5, (Surges): 2 kV Differential Mode / 4 kV Common Mode  IEC 61000-4-6, (Conducted disturbances immunity): 10 V IEC 61000-4-8, (Power frequency magnetic field): 30 A/m
<b>UPS enclosure IP rating</b>	IP20
<b>Earthing system</b>	This UPS can be connected to TN, TT, IT electrical supply system, same system is supplied to the load.
<b>Operating temperature</b>	0 to 40 °C (32 to 104 °F)
<b>Storage temperature</b>	-15 to 55°C (4.5 to 131 °F)
<b>Relative humidity</b>	0 to 85% (without condensation)
<b>Operating altitude</b>	Up to 3,000 meters (9,843 ft) above sea level, no derating for 40°C (104°F) room temperature. Above 2,000 meters (6,526ft) apply a derating 1% of load per 100 meters.
<b>Transit altitude</b>	Up to 10,000 meters (32,808 ft) above sea level
<b>Audible noise</b>	<25dBA
<b>Overvoltage Category</b>	Category II
<b>Pollution degree</b>	PD2

## 10 Glossary

Backup time	Time during which the load can be supplied by the UPS operating on battery power.
Low-battery warning	This is a battery-voltage level indicating that battery power is low and that the user must take action before the UPS shuts down.
Load	Devices or equipment connected to the UPS output.
Normal mode	The normal UPS operating mode in which the AC source supplies the UPS which, in turn, provides AC power to the connected loads.
Normal AC source	Normal source of power for the UPS.
OVL	Overload. When the load exceeds 100% of the maximum load of the UPS.
UPS	Uninterruptible Power System.