

Ergotron® LX

Dimensional & Range of Motion Illustrations

Wall Mount LCD Arm

Dimensions

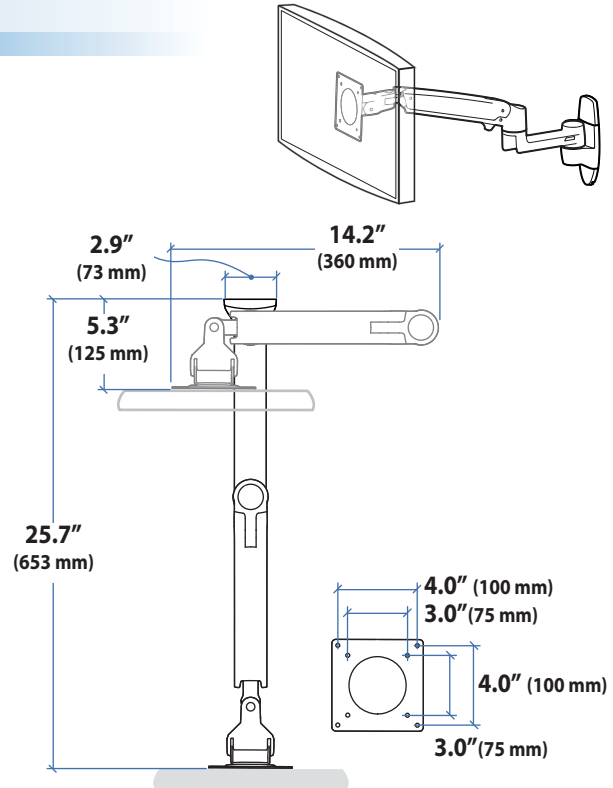
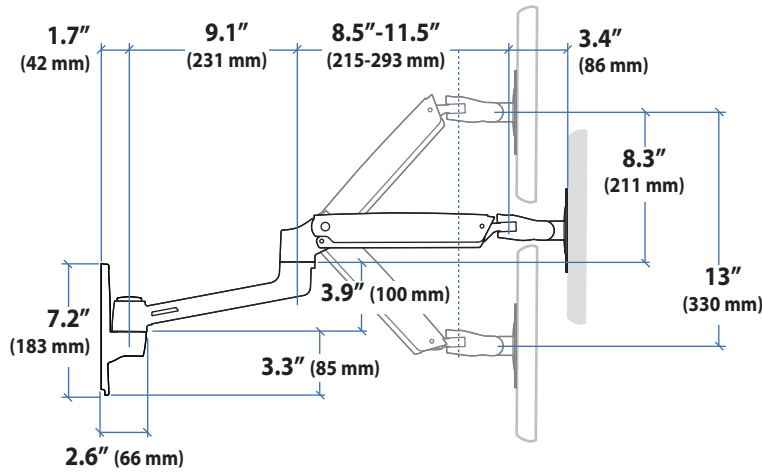

Wall Mount Bracket

Stud mounting:
M8 x 80mm or 5/16" x 3"
and flat washer 8mm or
5/16" (2 places)

Wall Track mounting:
Button head cap screw
#10-24 x 5/8" (4 places)

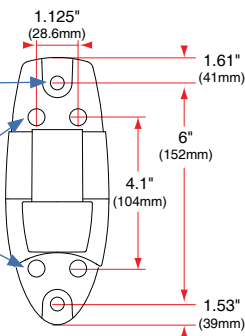

Range of Motion

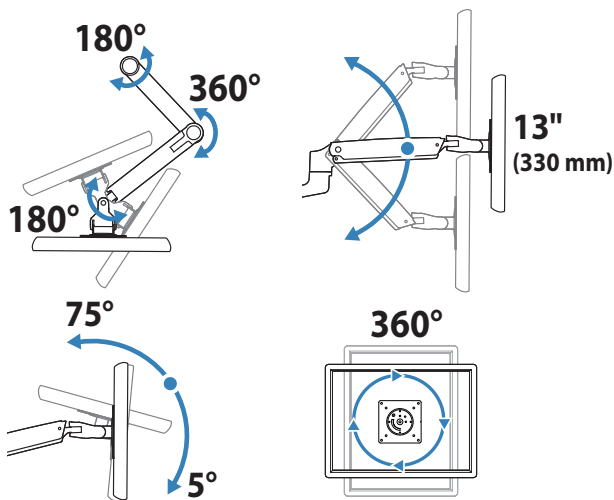

Weight Capacity

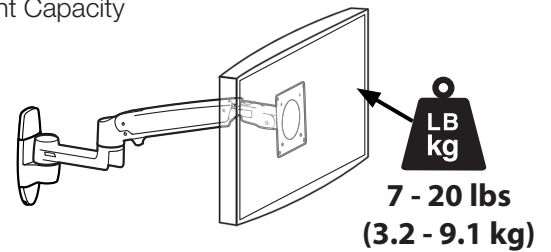

Monitor depth greater than 2.5" (64 mm) may diminish capacity.
Call Ergotron for more information.

© 2010 Ergotron, Inc. rev. 02/09/2010 DIM-LXWM Content is subject to change without notification

Americas Sales and Corporate Headquarters
St. Paul, MN USA
(800) 888-8458
+1-651-681-7600
www.ergotron.com
sales@ergotron.com

EMEA Sales
Amersfoort, The Netherlands
+31 33 45 45 600
www.ergotron.com
info.eu@ergotron.com

APAC Sale
Tokyo, Japan
www.ergotron.com
apaccustomerservice@ergotron.com

Worldwide OEM Sales
www.ergotron.com
info.oem@ergotron.com

