

PX45 / PX65 HIGH PERFORMANCE INDUSTRIAL PRINTER

Configuration Guide



PX65 6-INCH



PX45 4-INCH

THE
FUTURE
IS
WHAT
WE
MAKE IT

Honeywell

TABLE OF CONTENTS

- 1 TABLE OF CONTENTS**
- 2 PX45 PRINTING OPTIONS**
- 3 PX45 MEDIA SPECIFICATIONS**
- 4 PX45 MEDIA ROTATING UNWINDING MEDIA HANGER**
- 5 PX45 4-INCH FEATURE OVERVIEW**
 - TEAR OFF
 - 2.36" LCD WITH KEYPAD - THERMAL TRANSFER
 - 2.36" LCD WITH KEYPAD - THERMAL TRANSFER - **WIFI (ROW)**
 - 2.36" LCD WITH KEYPAD - THERMAL TRANSFER - **WIFI (NA)**
 - 2.36" LCD WITH KEYPAD - THERMAL TRANSFER - **RFID**
 - 2.36" LCD WITH KEYPAD - THERMAL TRANSFER - **PARALLEL INTERFACE**
 - CUTTER
 - 2.36" LCD WITH KEYPAD - THERMAL TRANSFER
 - 2.36" LCD WITH KEYPAD - THERMAL TRANSFER - **WIFI (ROW)**
 - REWINDER + LABEL TAKEN SENSOR
 - 2.36" LCD WITH KEYPAD - THERMAL TRANSFER
 - 2.36" LCD WITH KEYPAD - THERMAL TRANSFER - **WIFI (ROW)**
 - 2.36" LCD WITH KEYPAD - THERMAL TRANSFER - **WIFI (NA)**
 - 2.36" LCD WITH KEYPAD - PARALLEL INTERFACE
- 16 PX45 CONFIGURATION MAP INDUSTRIAL PRINTER**
- 17 PX65 PRINTING OPTIONS**
- 18 PX65 MEDIA SPECIFICATIONS**
- 19 PX65 MEDIA ROTATING UNWINDING MEDIA HANGER**
- 20 PX65 6-INCH FEATURE OVERVIEW**
 - TEAR OFF
 - 2.36" LCD WITH KEYPAD - THERMAL TRANSFER
 - 2.36" LCD WITH KEYPAD - THERMAL TRANSFER - **WIFI (ROW)**
- 22 PX65 6-INCH FEATURE OVERVIEW**
 - TEAR OFF
 - 2.36" LCD WITH KEYPAD - THERMAL TRANSFER - **WIFI (NA)**
 - 2.36" LCD WITH KEYPAD - THERMAL TRANSFER - **RFID**
 - 2.36" LCD WITH KEYPAD - THERMAL TRANSFER - **PARALLEL INTERFACE**
 - CUTTER
 - 2.36" LCD WITH KEYPAD - THERMAL TRANSFER
 - REWINDER + LABEL TAKEN SENSOR
 - 2.36" LCD WITH KEYPAD - THERMAL TRANSFER
 - 2.36" LCD WITH KEYPAD - THERMAL TRANSFER - **WIFI (ROW)**
 - 2.36" LCD WITH KEYPAD - THERMAL TRANSFER - **WIFI (NA)**
- 29 PX65 CONFIGURATION MAP INDUSTRIAL PRINTER**
- 30 HONEYWELL EDGE SERVICES**
 - GOLD REPAIR SERVICES - 3 YEAR
 - PLATINUM REPAIR SERVICES - 3 YEAR
 - GOLD REPAIR SERVICES - 5 YEAR
 - PLATINUM REPAIR SERVICES - 5 YEAR
 - PX45/ PX65 - REPAIR SERVICES COVERAGE
- 33 ACCESSORIES**
 - PX45/ PX65 - I/O CARDS
 - PX45/ PX65 - WIFI CARD
 - PX45 4-INCH CUTTER
 - PX65 6-INCH CUTTER
 - CONSUMABLES AND CABLES
- 37 MISCELLANEOUS AC CORDS**
- 38 APPENDIX**
 - PX4IE/ PX6IE VS PX45/ PX65 ACCESSORIES
 - PX KEYBOARDS - COMPARE PX4I, PX4IE AND PX45
 - PX CONNECTIVITY - COMPARE PX4I, PX4IE AND PX45
 - PX MEDIA COMPARTMENT - COMPARE PX4 TO PX4IE/ PX45

PX45 PRINTING OPTIONS



Tear Off

Most commonly used, print any number of labels and simply tear the labels off from the printer at the end of the print job.

This method of printing is available on any PX45 configuration.



Cutter

A cutter can be added to any configuration of PX45, simply cutting between labels, or at intervals on continuous media.

This method of printing is available on any PX45 configuration.



Peel & Present (Self-Strip)

Self-Strip prints and presents only one label at a time already peeled from the backing strip/ liner, the next label will only be printed once the original label is removed from the media path.

Must be ordered from factory, not field installable.

PX45Axxxxx2xxxx PX45 with Internal Rewind + LTS

ID = Inside Diameter
OD = Outside Diameter

PX45 MEDIA

Specifications

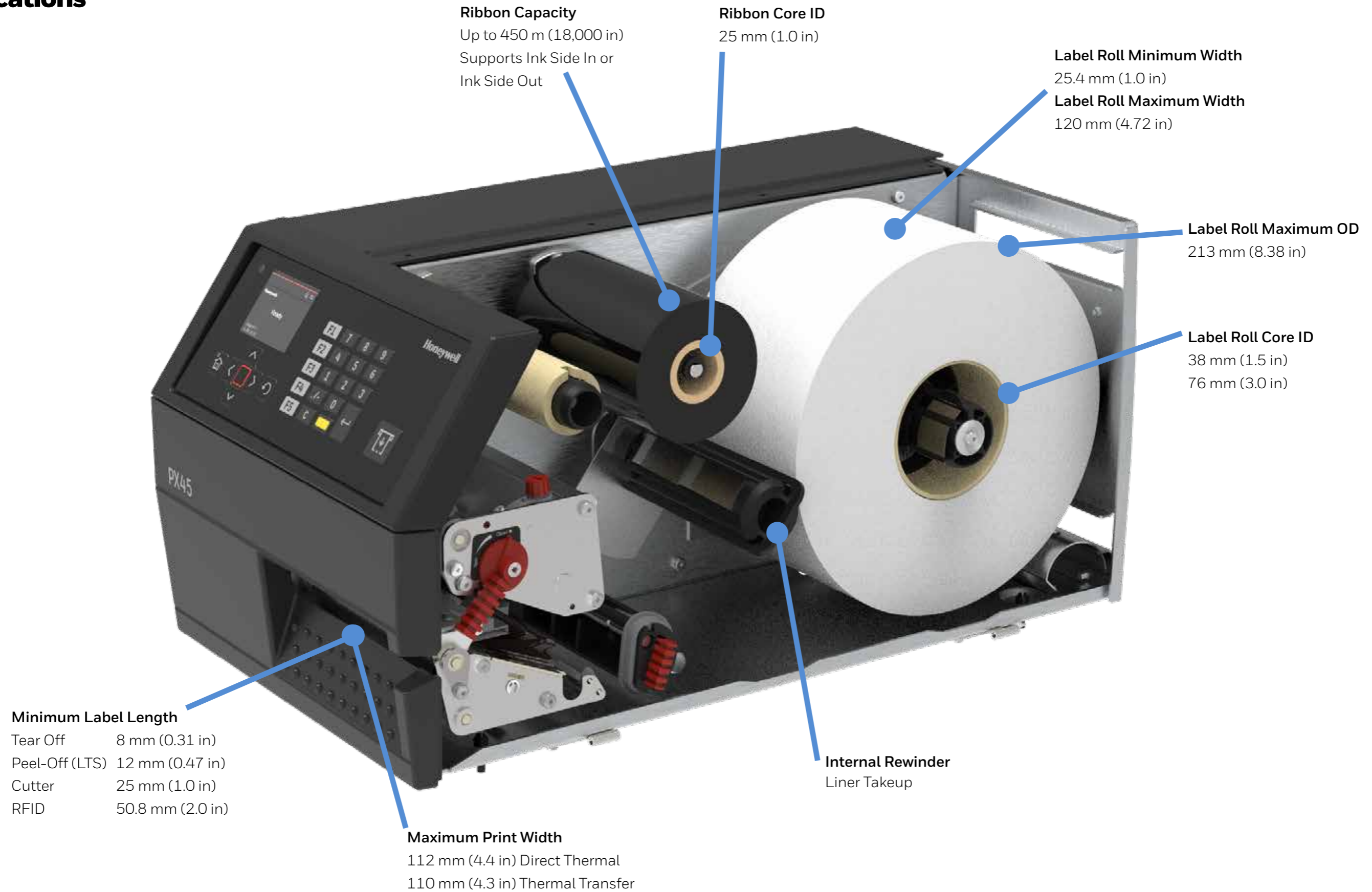

Ribbon Capacity
Up to 450 m (18,000 in)
Supports Ink Side In or
Ink Side Out

Ribbon Core ID
25 mm (1.0 in)

Label Roll Minimum Width
25.4 mm (1.0 in)
Label Roll Maximum Width
120 mm (4.72 in)

Label Roll Maximum OD
213 mm (8.38 in)

Label Roll Core ID
38 mm (1.5 in)
76 mm (3.0 in)

Minimum Label Length

Tear Off	8 mm (0.31 in)
Peel-Off (LTS)	12 mm (0.47 in)
Cutter	25 mm (1.0 in)
RFID	50.8 mm (2.0 in)

Maximum Print Width
112 mm (4.4 in) Direct Thermal
110 mm (4.3 in) Thermal Transfer

Internal Rewinder
Liner Takeup

ID = Inside Diameter
OD = Outside Diameter

PX45 MEDIA

Rotating Unwinding Media Hanger



Rotating Media Hanger with 76 mm (3.0 in) Core Adapter
No media installed

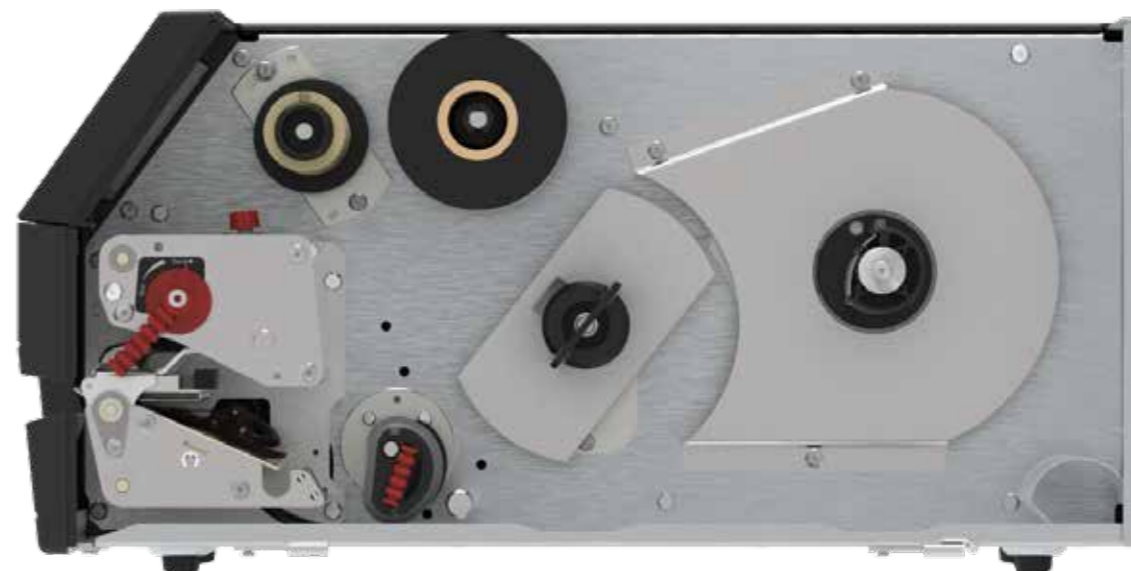

Rotating Media Hanger - 38 mm (1.5 in)
No media installed



Rotating Media Hanger + Label Roll Core 76 mm (3.0 in) ID
Shown with Label Roll 213 mm (8.38 in) OD
Typical length of material with typical thickness of labels ~ 195 m



Rotating Media Hanger + Label Roll Core 38 mm (1.5 in) ID
Shown with Label Roll 213 mm (8.38 in) OD
Typical length of material with typical thickness of labels ~ 220 m

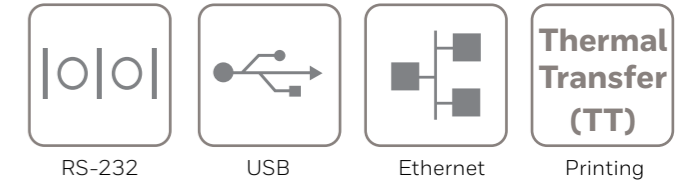

PX45 4-INCH FEATURE OVERVIEW

Tear Off - 2.36" LCD with Keypad - Thermal Transfer



PX45 - 2.36" LCD with Keypad - Thermal Transfer - 203 DPI

PX45A00000000200

PX45, 2.36" LCD with Keypad, Ethernet, Rotating Hanger, Real Time Clock (RTC), Thermal Transfer (TT), 203 DPI, US & EU Power Cord

PX45 - 2.36" LCD with Keypad - Thermal Transfer - 300 DPI

PX45A00000000300

PX45, 2.36" LCD with Keypad, Ethernet, Rotating Hanger, Real Time Clock (RTC), Thermal Transfer (TT), 300 DPI, US & EU Power Cord

PX45 - 2.36" LCD with Keypad - Thermal Transfer - 406 DPI

PX45A00000000400

PX45, 2.36" LCD with Keypad, Ethernet, Rotating Hanger, Real Time Clock (RTC), Thermal Transfer (TT), 406 DPI, US & EU Power Cord

Included in the box:

- PX45
- PX45 Regulatory Sheet (PX45-65-ML-RS)
- Ribbon Core (048524)



- US & EU Power Cord

Note: Not all printer combinations are available in every region. Check your local Price Book to see which part numbers are available for sale.

Honeywell Repair Services

SVCPX45-SG3N

PX45, Edge Service, Gold Maintenance Contract, 3 Year, New Contract

ADD SVCPRINTHEAD-PRN3

AddOn, Edge Service, Printhead Refresh Service, 203 or 300 DPI, 3-Year Contract

ADD SVCACC-PRN3

AddOn, Edge Service, Accessory Service, Printer, 3 Year

PX45 4-INCH FEATURE OVERVIEW

Tear Off - 2.36" LCD with Keypad - Thermal Transfer - WiFi (ROW)

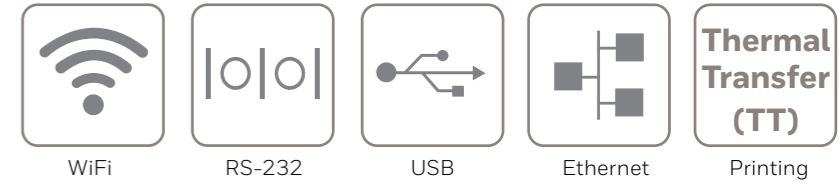

PX45 - 2.36" LCD with Keypad - WiFi (ROW) - Thermal Transfer - 203 DPI

PX45A02000000200

PX45, 2.36" LCD with Keypad, Ethernet, WiFi Rest of World (ROW) IEEE 802.11 a/b/g/n/ac, Rotating Hanger, Real Time Clock (RTC), Thermal Transfer (TT), 203 DPI, US & EU Power Cord

Included in the box:

- PX45
- PX45 Regulatory Sheet (PX45-65-ML-RS)
- Ribbon Core (048524)



- US & EU Power Cord

Note: Not all printer combinations are available in every region. Check your local Price Book to see which part numbers are available for sale.

Honeywell Repair Services

SVCPX45-SG3N

PX45, Edge Service, Gold Maintenance Contract, 3 Year, New Contract

ADD SVCPRINTHEAD-PRN3

AddOn, Edge Service, Printhead Refresh Service, 203 or 300 DPI, 3-Year Contract

ADD SVCACC-PRN3

AddOn, Edge Service, Accessory Service, Printer, 3 Year

PX45 4-INCH FEATURE OVERVIEW

Tear Off - 2.36" LCD with Keypad - Thermal Transfer - WiFi (NA)

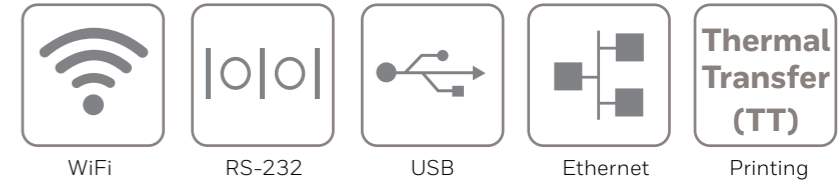

PX45 - 2.36" LCD with Keypad - WiFi (NA) - Thermal Transfer - 203 DPI

PX45A01000000201

PX45, 2.36" LCD with Keypad, Ethernet, WiFi Rest of World (NA) IEEE 802.11 a/b/g/n/ac, Rotating Hanger, Real Time Clock (RTC), Thermal Transfer (TT), 203 DPI, US Power Cord

PX45 - 2.36" LCD with Keypad - WiFi (NA) - Thermal Transfer - 406 DPI

PX45A01000000401

PX45, 2.36" LCD with Keypad, Ethernet, WiFi Rest of World (NA) IEEE 802.11 a/b/g/n/ac, Rotating Hanger, Real Time Clock (RTC), Thermal Transfer (TT), 406 DPI, US Power Cord

Included in the box:

- PX45
- PX45 Regulatory Sheet (PX45-65-ML-RS)
- Ribbon Core (048524)



- US Power Cord

Note: Not all printer combinations are available in every region. Check your local Price Book to see which part numbers are available for sale.

Honeywell Repair Services

SVCPX45-SG3N

PX45, Edge Service, Gold Maintenance Contract, 3 Year, New Contract

ADD SVCPRINTHEAD-PRN3

AddOn, Edge Service, Printhead Refresh Service, 203 or 300 DPI, 3-Year Contract

ADD SVCACC-PRN3

AddOn, Edge Service, Accessory Service, Printer, 3 Year

PX45 4-INCH FEATURE OVERVIEW

Tear Off - 2.36" LCD with Keypad - Thermal Transfer - RFID

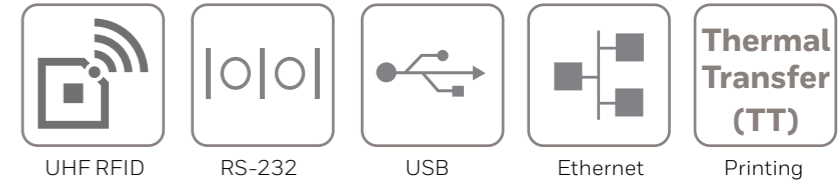

PX45 - 2.36" LCD with Keypad - UHF RFID EU - Thermal Transfer - 203 DPI

PX45A00EU0000200 PX45, 2.36" LCD with Keypad, Ethernet, UHF RFID EU, Rotating Hanger, Real Time Clock (RTC), Thermal Transfer (TT), 203 DPI, US & EU Power Cord

PX45 - 2.36" LCD with Keypad - UHF RFID NA - Thermal Transfer - 203 DPI

PX45A00NA0000201 PX45, 2.36" LCD with Keypad, Ethernet, UHF RFID NA, Rotating Hanger, Real Time Clock (RTC), Thermal Transfer (TT), 203 DPI, US Power Cord

Included in the box:

- PX45
- PX45 Regulatory Sheet (PX45-65-ML-RS)
- Ribbon Core (048524)



- US & EU Power Cord





Note: Not all printer combinations are available in every region. Check your local Price Book to see which part numbers are available for sale.

Honeywell Repair Services

SVC PX45-SG3N	PX45, Edge Service, Gold Maintenance Contract, 3 Year, New Contract
ADD SVCPRINTHEAD-PRN3	AddOn, Edge Service, Printhead Refresh Service, 203 or 300 DPI, 3-Year Contract
ADD SVCACC-PRN3	AddOn, Edge Service, Accessory Service, Printer, 3 Year

PX45 4-INCH FEATURE OVERVIEW

Tear Off - 2.36" LCD with Keypad - Thermal Transfer - Parallel Interface

 Parallel Interface I/O Option 1	 RS-232	 USB	 Ethernet	 Thermal Transfer (TT) Printing
---	---	--	---	---



PX45 - 2.36" LCD with Keypad - Parallel Interface - Thermal Transfer - 203 DPI

PX45A00010000200 PX45, 2.36" LCD with Keypad, Ethernet, Parallel Interface, Rotating Hanger, Real Time Clock (RTC), Thermal Transfer (TT), 203 DPI, US & EU Power Cord

PX45 - 2.36" LCD with Keypad - Parallel Interface - Thermal Transfer - 406 DPI

PX45A00010000400 PX45, 2.36" LCD with Keypad, Ethernet, Parallel Interface, Rotating Hanger, Real Time Clock (RTC), Thermal Transfer (TT), 203 DPI, US Power Cord

Included in the box:

- PX45
- PX45 Regulatory Sheet (PX45-65-ML-RS)
- Ribbon Core (048524)



- US & EU Power Cord

Note: Not all printer combinations are available in every region. Check your local Price Book to see which part numbers are available for sale.

Honeywell Repair Services

SVC SVC PX45-SG3N	PX45, Edge Service, Gold Maintenance Contract, 3 Year, New Contract
ADD SVC PRINT HEAD-PRN3	AddOn, Edge Service, Printhead Refresh Service, 203 or 300 DPI, 3-Year Contract
ADD SVC ACC-PRN3	AddOn, Edge Service, Accessory Service, Printer, 3 Year

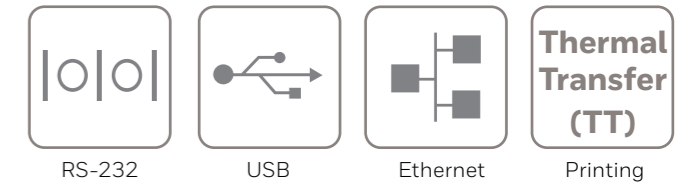

PX45 4-INCH FEATURE OVERVIEW

Cutter - 2.36" LCD with Keypad - Thermal Transfer



PX45 - 2.36" LCD with Keypad - Cutter - Thermal Transfer - 300 DPI

PX45A00000030300

PX45, 2.36" LCD with Keypad, Ethernet, Cutter, Rotating Hanger, Real Time Clock (RTC), Thermal Transfer (TT), 300 DPI, US & EU Power Cord

Included in the box:

- PX45
- PX45 Regulatory Sheet (PX45-65-ML-RS)
- Ribbon Core (048524)



- US & EU Power Cord

Note: Not all printer combinations are available in every region. Check your local Price Book to see which part numbers are available for sale.

Honeywell Repair Services

SVCPX45-SG3N

PX45, Edge Service, Gold Maintenance Contract, 3 Year, New Contract

ADD SVCPRINTHEAD-PRN3

AddOn, Edge Service, Printhead Refresh Service, 203 or 300 DPI, 3-Year Contract

ADD SVCACC-PRN3

AddOn, Edge Service, Accessory Service, Printer, 3 Year

ADD SVCCUTTER2-PRN3

AddOn, Edge Service, Cutter Service for Printers, 3 Year

PX45 4-INCH FEATURE OVERVIEW

Cutter - 2.36" LCD with Keypad - Thermal Transfer - WiFi (ROW)

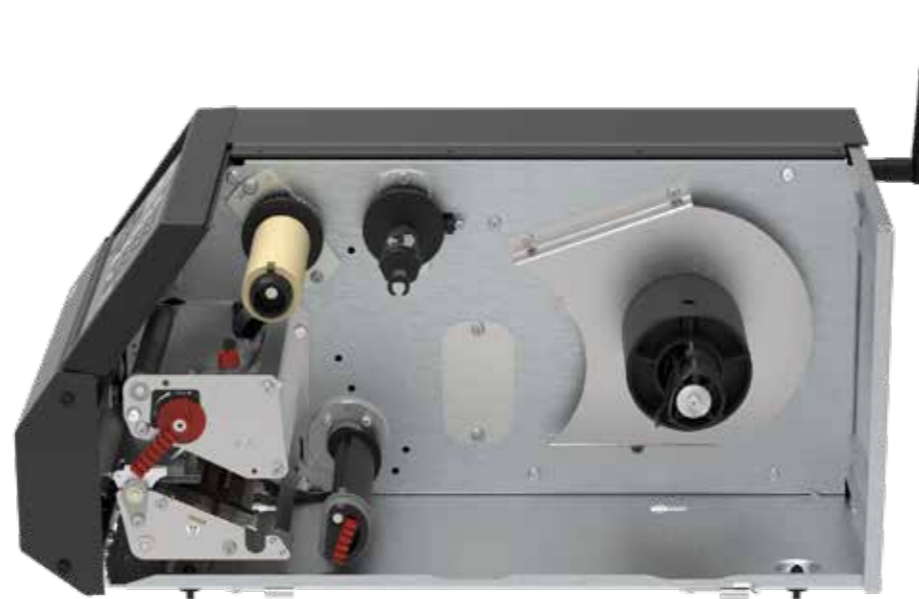
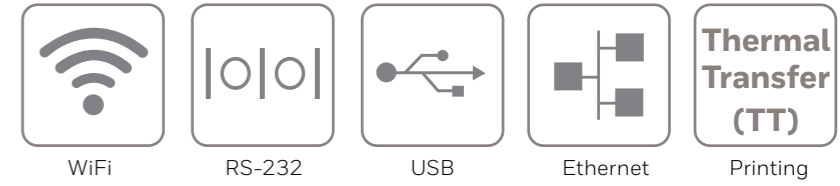

PX45 - 2.36" LCD with Keypad - WiFi (ROW) - Cutter - Thermal Transfer - 203 DPI

PX45A02000030200

PX45, 2.36" LCD with Keypad, Ethernet, WiFi Rest of World (ROW) IEEE 802.11 a/b/g/n/ac, Cutter, Rotating Hanger, Real Time Clock (RTC), Thermal Transfer (TT), 203 DPI, US & EU Power Cord

Included in the box:

- PX45
- PX45 Regulatory Sheet (PX45-65-ML-RS)
- Ribbon Core (048524)



- US & EU Power Cord

Note: Not all printer combinations are available in every region. Check your local Price Book to see which part numbers are available for sale.

Honeywell Repair Services

SVC PX45-SG3N	PX45, Edge Service, Gold Maintenance Contract, 3 Year, New Contract
ADD SVCPRINTHEAD-PRN3	AddOn, Edge Service, Printhead Refresh Service, 203 or 300 DPI, 3-Year Contract
ADD SVCACC-PRN3	AddOn, Edge Service, Accessory Service, Printer, 3 Year
ADD SVCCUTTER2-PRN3	AddOn, Edge Service, Cutter Service for Printers, 3 Year

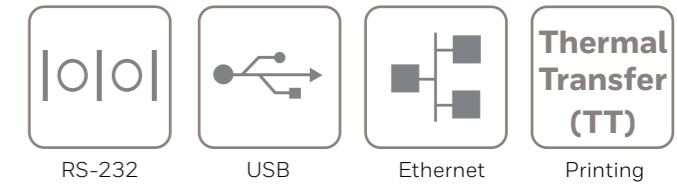

PX45 4-INCH FEATURE OVERVIEW

Rewinder + Label Taken Sensor - 2.36" LCD with Keypad - Thermal Transfer



PX45 - 2.36" LCD with Keypad - Internal Rewind + Label Taken Sensor - Thermal Transfer - 203 DPI

PX45A00000020200 PX45, 2.36" LCD with Keypad, Ethernet, Rotating Hanger, Rewinder + Label Taken Sensor, Real Time Clock (RTC), Thermal Transfer (TT), 203 DPI, US & EU Power Cord

PX45 - 2.36" LCD with Keypad - Internal Rewind + Label Taken Sensor - Thermal Transfer - 300 DPI

PX45A00000020300 PX45, 2.36" LCD with Keypad Ethernet, Rotating Hanger, Rewinder + Label Taken Sensor, Real Time Clock (RTC), Thermal Transfer (TT), 300 DPI, US & EU Power Cord

PX45 - 2.36" LCD with Keypad - Internal Rewind + Label Taken Sensor - Thermal Transfer - 406 DPI

PX45A00000020400 PX45, 2.36" LCD with Keypad, Ethernet, Rotating Hanger, Rewinder + Label Taken Sensor, Real Time Clock (RTC), Thermal Transfer (TT), 406 DPI, US & EU Power Cord

Included in the box:

- PX45
- PX45 Regulatory Sheet (PX45-65-ML-RS)
- Ribbon Core (048524)
- Batch Plate (1-040253-01)



- US & EU Power Cord

Note: Not all printer combinations are available in every region. Check your local Price Book to see which part numbers are available for sale.

Honeywell Repair Services

SVCPX45-SG3N

PX45, Edge Service, Gold Maintenance Contract, 3 Year, New Contract

ADD SVCPRINTHEAD-PRN3

AddOn, Edge Service, Printhead Refresh Service, 203 or 300 DPI, 3-Year Contract

ADD SVCACC-PRN3

AddOn, Edge Service, Accessory Service, Printer, 3 Year

PX45 4-INCH FEATURE OVERVIEW

Rewinder + Label Taken Sensor - 2.36" LCD with Keypad - Thermal Transfer - WiFi (ROW)

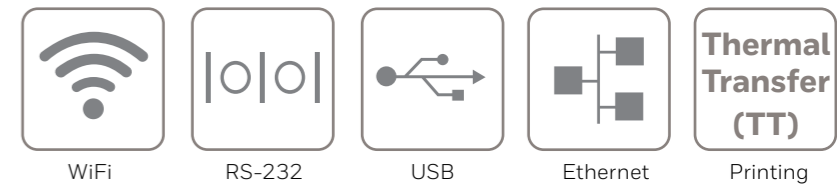

PX45 - 2.36" LCD with Keypad - WiFi (ROW) - Internal Rewind + Label Taken Sensor - Thermal Transfer - 203 DPI

PX45A02000020200

PX45, 2.36" LCD with Keypad, Ethernet, WiFi Rest of World (ROW) IEEE 802.11 a/b/g/n/ac, Rotating Hanger, Rewinder + Label Taken Sensor, Real Time Clock (RTC), Thermal Transfer (TT), 203 DPI, US & EU Power Cord

Included in the box:

- PX45
- PX45 Regulatory Sheet (PX45-65-ML-RS)
- Ribbon Core (048524)
- Batch Plate (1-040253-01)



- US & EU Power Cord

Note: Not all printer combinations are available in every region. Check your local Price Book to see which part numbers are available for sale.

Honeywell Repair Services

SVCPX45-SG3N

PX45, Edge Service, Gold Maintenance Contract, 3 Year, New Contract

ADD SVCPRINTHEAD-PRN3

AddOn, Edge Service, Printhead Refresh Service, 203 or 300 DPI, 3-Year Contract

ADD SVCACC-PRN3

AddOn, Edge Service, Accessory Service, Printer, 3 Year

PX45 4-INCH FEATURE OVERVIEW

Rewinder + Label Taken Sensor - 2.36" LCD with Keypad - Thermal Transfer - WiFi (NA)

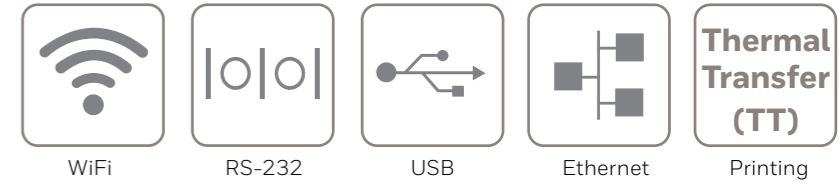

PX45 - 2.36" LCD with Keypad - WiFi (NA) - Internal Rewind + Label Taken Sensor - Thermal Transfer - 203 DPI

PX45A01000020201

PX45, 2.36" LCD with Keypad, Ethernet, WiFi Rest of World (NA) IEEE 802.11 a/b/g/n/ac, Rotating Hanger, Rewinder + Label Taken Sensor, Real Time Clock (RTC), Thermal Transfer (TT), 203 DPI, US Power Cord

Included in the box:

- PX45
- PX45 Regulatory Sheet (PX45-65-ML-RS)
- Ribbon Core (048524)
- Batch Plate (1-040253-01)



- US Power Cord

Note: Not all printer combinations are available in every region. Check your local Price Book to see which part numbers are available for sale.

Honeywell Repair Services

SVCPX45-SG3N

PX45, Edge Service, Gold Maintenance Contract, 3 Year, New Contract

ADD SVCPRINTHEAD-PRN3

AddOn, Edge Service, Printhead Refresh Service, 203 or 300 DPI, 3-Year Contract

ADD SVCACC-PRN3

AddOn, Edge Service, Accessory Service, Printer, 3 Year

PX45 4-INCH FEATURE OVERVIEW

Rewinder + Label Taken Sensor - 2.36" LCD with Keypad - Parallel Interface

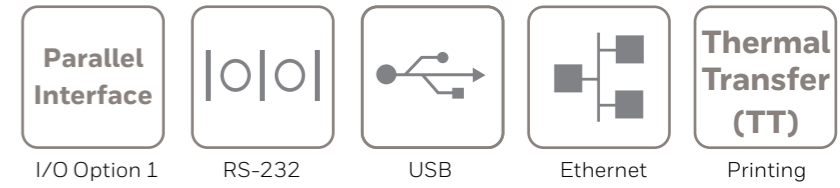

PX45 - 2.36" LCD with Keypad - Internal Rewind + Label Taken Sensor - Parallel Interface - Thermal Transfer - 203 DPI

PX45A00010020200 PX45, 2.36" LCD with Keypad, Ethernet, Parallel Interface, Rotating Hanger, Rewinder + Label Taken Sensor, Real Time Clock (RTC), Thermal Transfer (TT), 203 DPI, US & EU Power Cord

PX45 - 2.36" LCD with Keypad - Internal Rewind + Label Taken Sensor - Parallel Interface - Thermal Transfer - 406 DPI

PX45A00010020400 PX45, 2.36" LCD with Keypad, Ethernet, Parallel Interface, Rotating Hanger, Rewinder + Label Taken Sensor, Real Time Clock (RTC), Thermal Transfer (TT), 406 DPI, US & EU Power Cord

Included in the box:

- PX45
- PX45 Regulatory Sheet (PX45-65-ML-RS)
- Ribbon Core (048524)
- Batch Plate (1-040253-01)



- US & EU Power Cord

Note: Not all printer combinations are available in every region. Check your local Price Book to see which part numbers are available for sale.

Honeywell Repair Services

SVCPX45-SG3N

PX45, Edge Service, Gold Maintenance Contract, 3 Year, New Contract

ADD SVCPRINHEAD-PRN3

AddOn, Edge Service, Printhead Refresh Service, 203 or 300 DPI, 3-Year Contract

ADD SVCACC-PRN3

AddOn, Edge Service, Accessory Service, Printer, 3 Year

PX45 CONFIGURATION MAP

Industrial Printer

VERSION	STANDARD	CONNECTIVITY	I/O OPTION 1	I/O OPTION 2	MEDIA OPTIONS	MEDIA HANDLING	PRINT OPTION	POWER CORD	DESCRIPTION	NOTES
PX45										
A	0								Standard	1 x USB A Port (USB 2.0 Host), 1 x USB B Port (USB 2.0 Device), 1 x DB9F (RS-232, up to 115.2 KB/s), Real Time Clock (RTC)
		0							Standard	
			0						Ethernet	Ethernet 10/100/1000 Mbps
				1					Ethernet + WLAN North America (NA)	Available as Kit - Part# 50147002-001 WiFi 802.11 a/b/g/n/ac (North America)
					2				Ethernet + WLAN Rest Of World (ROW)	Available as Kit - Part# 50147002-002 WiFi 802.11 a/b/g/n/ac (Rest Of World)
						00			None	
							01		Parallel Interface	Available as Kit - Part# 50147017-001 PARALLEL IEEE 1284 INTERFACE
								EU	UHF RFID Europe (EU) - 869MHz	Available as Kit - Part# 50147010-002 KIT RFID, 869MHz, PX45, EU
								NA	UHF RFID North America (NA) - 915MHz	Available as Kit - Part# 50147009-002 KIT RFID, 915MHz, PX45, North America
									00	None
									01	Parallel Interface
									EU	UHF RFID Europe (EU) - 869MHz
									NA	UHF RFID North America (NA) - 915MHz
									0	None
									2	Enhanced Rewinder + Label Taken Sensor (LTS)
									3	Cutter
										Available as Kit - Part# 1-041574-900 KIT CUTTER, PX4i + PX4ie + PX45
									0	Rotating Unwinding Media Hanger
									20	Thermal Transfer (TT) 203 DPI
									30	Thermal Transfer (TT) 300 DPI
									40	Thermal Transfer (TT) 406 DPI
									0	US & EU Power Cord
									1	US Power Cord
									6	India Power Cord



PX65 PRINTING OPTIONS



Tear Off

Most commonly used, print any number of labels and simply tear the labels off from the printer at the end of the print job.

This method of printing is available on any PX65 configuration.

Cutter

A cutter can be added to any configuration of PX65, simply cutting between labels, or at intervals on continuous media.

This method of printing is available on any PX65 configuration.

Peel & Present (Self-Strip)

Self-Strip prints and presents only one label at a time already peeled from the backing strip/ liner, the next label will only be printed once the original label is removed from the media path.

Must be ordered from factory, not field installable.

PX65Axxxxx1xxxx PX65 with Internal Rewind + LTS

ID = Inside Diameter
 OD = Outside Diameter

PX65 MEDIA

Specifications

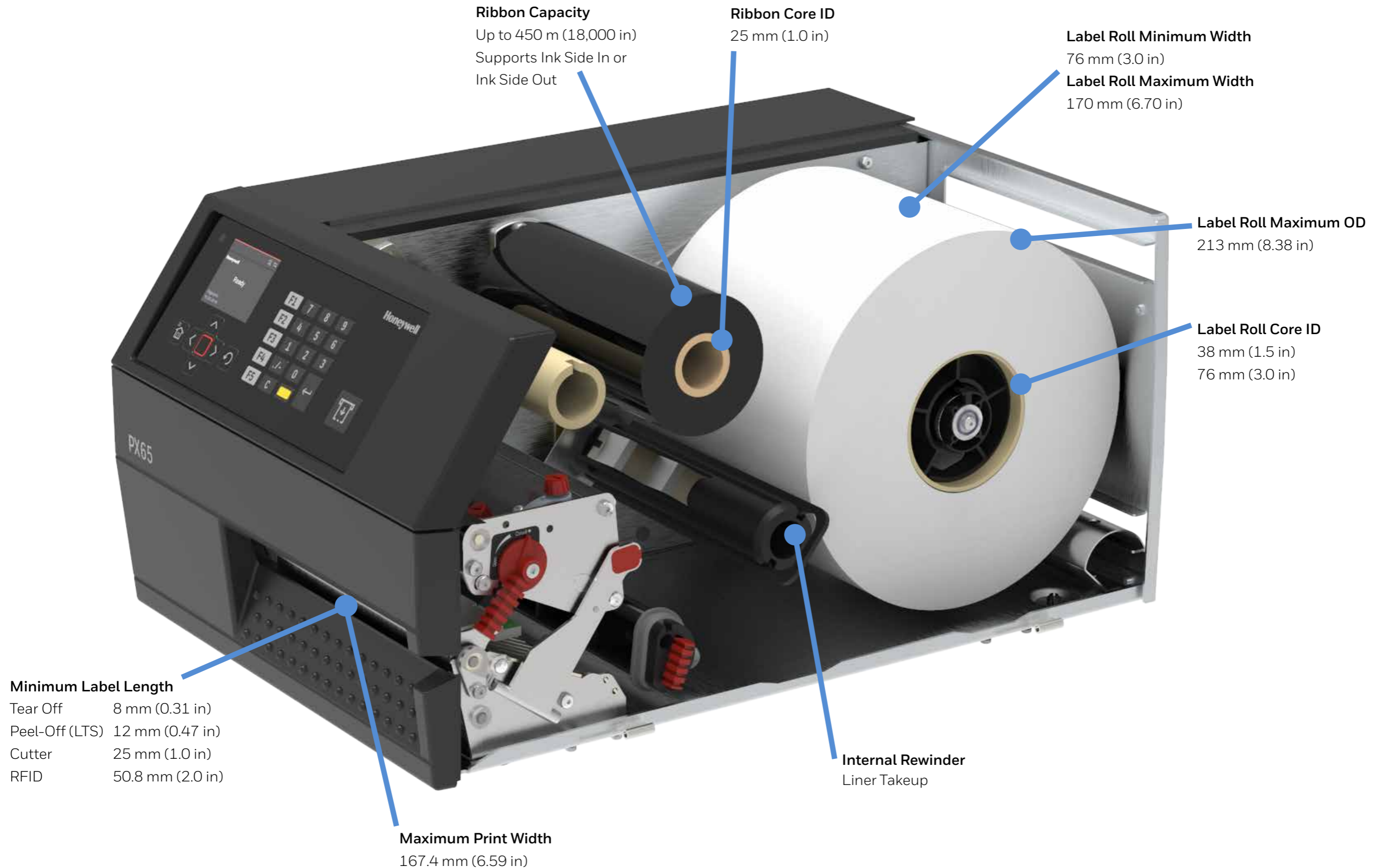

ID = Inside Diameter
OD = Outside Diameter

PX65 MEDIA

Rotating Unwinding Media Hanger



Rotating Media Hanger with 76 mm (3.0 in) Core Adapter
No media installed



Rotating Media Hanger - 38 mm (1.5 in)
No media installed



Rotating Media Hanger + Label Roll Core 76 mm (3.0 in) ID
Shown with Label Roll 213 mm (8.38 in) OD
Typical length of material with typical thickness of labels ~ 195 m



Rotating Media Hanger + Label Roll Core 38 mm (1.5 in) ID
Shown with Label Roll 213 mm (8.38 in) OD
Typical length of material with typical thickness of labels ~ 220 m

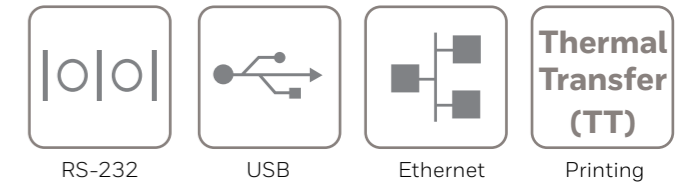

PX65 6-INCH FEATURE OVERVIEW

Tear Off - 2.36" LCD with Keypad - Thermal Transfer



PX65 - 2.36" LCD with Keypad - Thermal Transfer - 203 DPI

PX65A0000000200

PX65, 2.36" LCD with Keypad, Ethernet, Rotating Hanger, Real Time Clock (RTC), Thermal Transfer (TT), 203 DPI, US & EU Power Cord

PX65 - 2.36" LCD with Keypad - Thermal Transfer - 300 DPI

PX65A0000000300

PX65, 2.36" LCD with Keypad, Ethernet, Rotating Hanger, Real Time Clock (RTC), Thermal Transfer (TT), 300 DPI, US & EU Power Cord

Included in the box:

- PX65
- PX65 Regulatory Sheet (PX45-65-ML-RS)
- Ribbon Core (061605-001)



- US & EU Power Cord

Note: Not all printer combinations are available in every region. Check your local Price Book to see which part numbers are available for sale.

Honeywell Repair Services

SVCPX65-SG3N

PX65, Edge Service, Gold Maintenance Contract, 3 Year, New Contract

ADD SVCPRINTHEAD-PRN3

AddOn, Edge Service, Printhead Refresh Service, 203 or 300 DPI, 3-Year Contract

ADD SVCACC-PRN3

AddOn, Edge Service, Accessory Service, Printer, 3 Year

PX65 6-INCH FEATURE OVERVIEW

Tear Off - 2.36" LCD with Keypad - Thermal Transfer - WiFi (ROW)

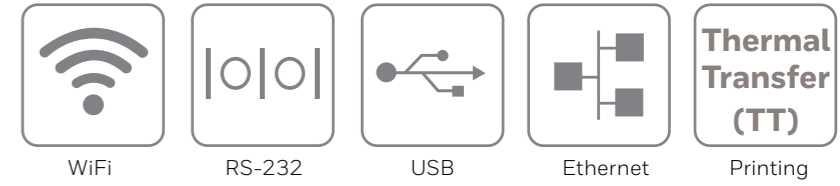

PX65 - 2.36" LCD with Keypad - WiFi (ROW) - Thermal Transfer - 203 DPI

PX65A02000000200

PX65, 2.36" LCD with Keypad, Ethernet, WiFi Rest of World (ROW) IEEE 802.11 a/b/g/n/ac, Rotating Hanger, Real Time Clock (RTC), Thermal Transfer (TT), 203 DPI, US & EU Power Cord

PX65 - 2.36" LCD with Keypad - WiFi (ROW) - Thermal Transfer - 300 DPI

PX65A02000000300

PX65, 2.36" LCD with Keypad, Ethernet, WiFi Rest of World (ROW) IEEE 802.11 a/b/g/n/ac, Rotating Hanger, Real Time Clock (RTC), Thermal Transfer (TT), 300 DPI, US & EU Power Cord

Included in the box:

- PX65
- PX65 Regulatory Sheet (PX45-65-ML-RS)
- Ribbon Core (061605-001)



- US & EU Power Cord

Note: Not all printer combinations are available in every region. Check your local Price Book to see which part numbers are available for sale.

Honeywell Repair Services

SVCPX65-SG3N

PX65, Edge Service, Gold Maintenance Contract, 3 Year, New Contract

ADD SVCPRINTHEAD-PRN3

AddOn, Edge Service, Printhead Refresh Service, 203 or 300 DPI, 3-Year Contract

ADD SVCACC-PRN3

AddOn, Edge Service, Accessory Service, Printer, 3 Year

PX65 6-INCH FEATURE OVERVIEW

Tear Off - 2.36" LCD with Keypad - Thermal Transfer - WiFi (NA)

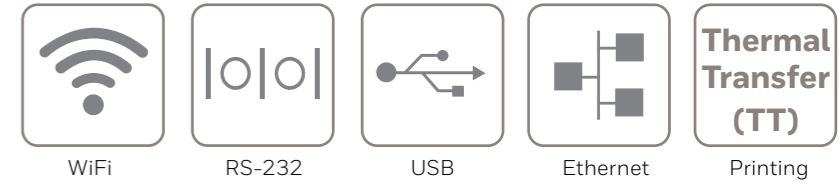

PX65 - 2.36" LCD with Keypad - WiFi (NA) - Thermal Transfer - 203 DPI

PX65A01000000201

PX65, 2.36" LCD with Keypad, Ethernet, WiFi Rest of World (NA) IEEE 802.11 a/b/g/n/ac, Rotating Hanger, Real Time Clock (RTC), Thermal Transfer (TT), 203 DPI, US Power Cord

Included in the box:

- PX65
- PX65 Regulatory Sheet (PX45-65-ML-RS)
- Ribbon Core (061605-001)



- US Power Cord

Note: Not all printer combinations are available in every region. Check your local Price Book to see which part numbers are available for sale.

Honeywell Repair Services

SVCPX65-SG3N

PX65, Edge Service, Gold Maintenance Contract, 3 Year, New Contract

ADD SVCPRINTHEAD-PRN3

AddOn, Edge Service, Printhead Refresh Service, 203 or 300 DPI, 3-Year Contract

ADD SVCACC-PRN3

AddOn, Edge Service, Accessory Service, Printer, 3 Year

PX65 6-INCH FEATURE OVERVIEW

Tear Off - 2.36" LCD with Keypad - Thermal Transfer - RFID

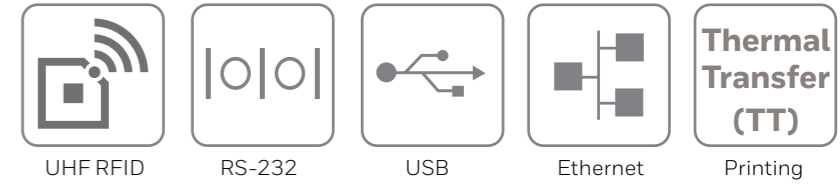

PX65 - 2.36" LCD with Keypad - UHF RFID EU - Thermal Transfer - 203 DPI

PX65A00EU0000200 PX65, 2.36" LCD with Keypad, Ethernet, UHF RFID EU, Rotating Hanger, Real Time Clock (RTC), Thermal Transfer (TT), 203 DPI, US & EU Power Cord

PX65 - 2.36" LCD with Keypad - UHF RFID NA - Thermal Transfer - 203 DPI

PX65A00NA0000201 PX65, 2.36" LCD with Keypad, Ethernet, UHF RFID NA, Rotating Hanger, Real Time Clock (RTC), Thermal Transfer (TT), 203 DPI, US & EU Power Cord

PX65 - 2.36" LCD with Keypad - UHF RFID EU - Thermal Transfer - 300 DPI

PX65A00EU0000300 PX65, 2.36" LCD with Keypad, Ethernet, UHF RFID EU, Rotating Hanger, Real Time Clock (RTC), Thermal Transfer (TT), 300 DPI, US & EU Power Cord

Included in the box:

- PX65
- PX65 Regulatory Sheet (PX45-65-ML-RS)
- Ribbon Core (061605-001)



- US & EU Power Cord

Note: Not all printer combinations are available in every region. Check your local Price Book to see which part numbers are available for sale.

Honeywell Repair Services

SVCPX65-SG3N PX65, Edge Service, Gold Maintenance Contract, 3 Year, New Contract

ADD SVCPRINHEAD-PRN3 AddOn, Edge Service, Printhead Refresh Service, 203 or 300 DPI, 3-Year Contract

ADD SVCACC-PRN3 AddOn, Edge Service, Accessory Service, Printer, 3 Year

PX65 6-INCH FEATURE OVERVIEW

Tear Off - 2.36" LCD with Keypad - Thermal Transfer - Parallel Interface

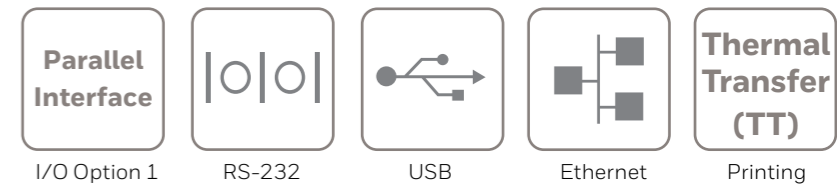

PX65 - 2.36" LCD with Keypad - Parallel Interface - Thermal Transfer - 203 DPI

PX65A00010000200 PX65, 2.36" LCD with Keypad, Ethernet, Parallel Interface, Rotating Hanger, Real Time Clock (RTC), Thermal Transfer (TT), 203 DPI, US & EU Power Cord

PX65 - 2.36" LCD with Keypad - Parallel Interface - Thermal Transfer - 300 DPI

PX65A00010000300 PX65, 2.36" LCD with Keypad, Ethernet, Parallel Interface, Rotating Hanger, Real Time Clock (RTC), Thermal Transfer (TT), 300 DPI, US & EU Power Cord

Included in the box:

- PX65
- PX65 Regulatory Sheet (PX45-65-ML-RS)
- Ribbon Core (061605-001)



- US & EU Power Cord

Note: Not all printer combinations are available in every region. Check your local Price Book to see which part numbers are available for sale.

Honeywell Repair Services

SVCPX65-SG3N PX65, Edge Service, Gold Maintenance Contract, 3 Year, New Contract

ADD SVCPRINTHEAD-PRN3 AddOn, Edge Service, Printhead Refresh Service, 203 or 300 DPI, 3-Year Contract

ADD SVCACC-PRN3 AddOn, Edge Service, Accessory Service, Printer, 3 Year

PX65 6-INCH FEATURE OVERVIEW

Cutter - 2.36" LCD with Keypad - Thermal Transfer

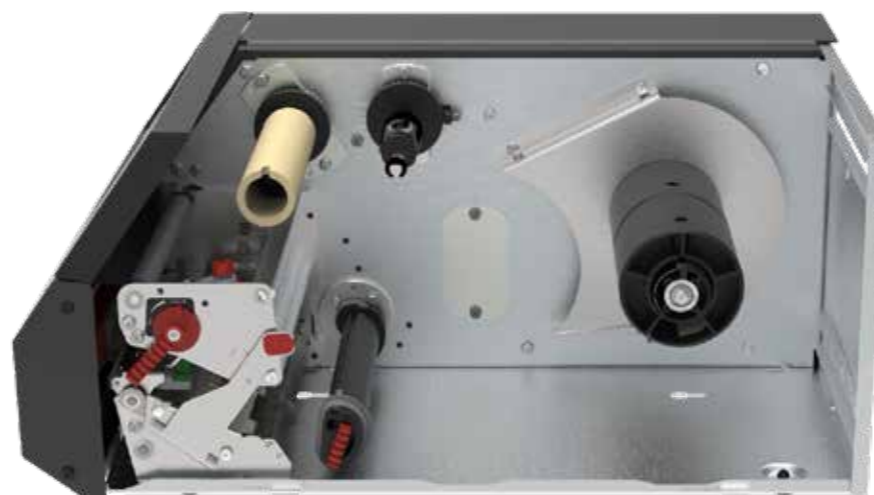
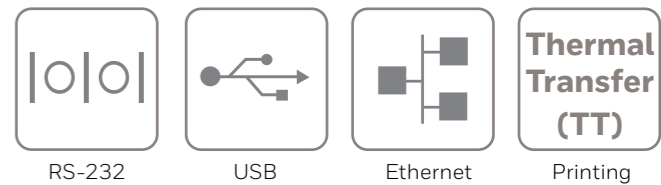

PX65 - 2.36" LCD with Keypad - Cutter - Thermal Transfer - 203 DPI

PX65A00000030200

PX65, 2.36" LCD with Keypad, Ethernet, Cutter, Rotating Hanger, Real Time Clock (RTC), Thermal Transfer (TT), 203 DPI, US & EU Power Cord

PX65 - 2.36" LCD with Keypad - Cutter - Thermal Transfer - 300 DPI

PX65A00000030300

PX65, 2.36" LCD with Keypad, Ethernet, Cutter, Rotating Hanger, Real Time Clock (RTC), Thermal Transfer (TT), 300 DPI, US & EU Power Cord

Included in the box:

- PX65
- PX65 Regulatory Sheet (PX45-65-ML-RS)
- Ribbon Core (061605-001)



- US & EU Power Cord

Note: Not all printer combinations are available in every region. Check your local Price Book to see which part numbers are available for sale.

Honeywell Repair Services

SVCPX65-SG3N

PX65, Edge Service, Gold Maintenance Contract, 3 Year, New Contract

ADD SVCPRINTHEAD-PRN3

AddOn, Edge Service, Printhead Refresh Service, 203 or 300 DPI, 3-Year Contract

ADD SVCACC-PRN3

AddOn, Edge Service, Accessory Service, Printer, 3 Year

ADD SVCCUTTER2-PRN3

AddOn, Edge Service, Cutter Service for Printers, 3 Year

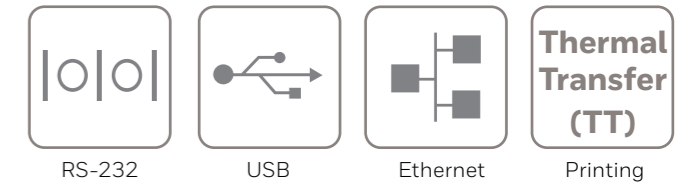

PX65 6-INCH FEATURE OVERVIEW

Rewinder + Label Taken Sensor - 2.36" LCD with Keypad - Thermal Transfer



PX65 - 2.36" LCD with Keypad - Internal Rewind + Label Taken Sensor - Thermal Transfer - 203 DPI

PX65A00000010200 PX65, 2.36" LCD with Keypad, Ethernet, Rotating Hanger, Rewinder + Label Taken Sensor, Real Time Clock (RTC), Thermal Transfer (TT), 203 DPI, US & EU Power Cord

PX65 - 2.36" LCD with Keypad - Internal Rewind + Label Taken Sensor - Thermal Transfer - 300 DPI

PX65A00000010300 PX65, 2.36" LCD with Keypad Ethernet, Rotating Hanger, Rewinder + Label Taken Sensor, Real Time Clock (RTC), Thermal Transfer (TT), 300 DPI, US & EU Power Cord

Included in the box:

- PX65
- PX65 Regulatory Sheet (PX45-65-ML-RS)
- Ribbon Core (061605-001)
- Batch Plate (1-040253-11)

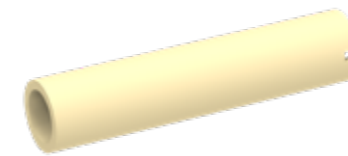

- US & EU Power Cord

Note: Not all printer combinations are available in every region. Check your local Price Book to see which part numbers are available for sale.

Honeywell Repair Services

SVC **PX65-SG3N** PX65, Edge Service, Gold Maintenance Contract, 3 Year, New Contract

ADD **SVC** **PRINTHEAD-PRN3** AddOn, Edge Service, Printhead Refresh Service, 203 or 300 DPI, 3-Year Contract

ADD **SVC** **ACC-PRN3** AddOn, Edge Service, Accessory Service, Printer, 3 Year

PX65 6-INCH FEATURE OVERVIEW

Rewinder + Label Taken Sensor - 2.36" LCD with Keypad - Thermal Transfer - WiFi (ROW)

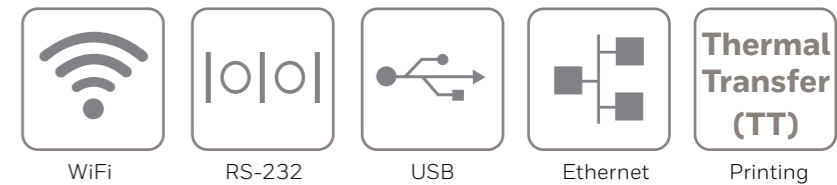

PX65 - 2.36" LCD with Keypad - WiFi (ROW) - Internal Rewind + Label Taken Sensor - Thermal Transfer - 203 DPI

PX65A02000000200 PX65, 2.36" LCD with Keypad, Ethernet, WiFi Rest of World (ROW) IEEE 802.11 a/b/g/n/ac, Rotating Hanger, Rewinder + Label Taken Sensor, Real Time Clock (RTC), Thermal Transfer (TT), 203 DPI, US & EU Power Cord

PX65 - 2.36" LCD with Keypad - WiFi (ROW) - Internal Rewind + Label Taken Sensor - Thermal Transfer - 300 DPI

PX65A02000000300 PX65, 2.36" LCD with Keypad, Ethernet, WiFi Rest of World (ROW) IEEE 802.11 a/b/g/n/ac, Rotating Hanger, Rewinder + Label Taken Sensor, Real Time Clock (RTC), Thermal Transfer (TT), 300 DPI, US & EU Power Cord

Included in the box:

- PX65
- PX65 Regulatory Sheet (PX45-65-ML-RS)
- Ribbon Core (061605-001)
- Batch Plate (1-040253-11)

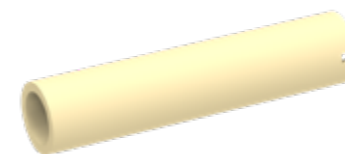

- US & EU Power Cord

Note: Not all printer combinations are available in every region. Check your local Price Book to see which part numbers are available for sale.

Honeywell Repair Services

SVCPX65-SG3N

PX65, Edge Service, Gold Maintenance Contract, 3 Year, New Contract

ADD SVCPRINTHEAD-PRN3

AddOn, Edge Service, Printhead Refresh Service, 203 or 300 DPI, 3-Year Contract

ADD SVCACC-PRN3

AddOn, Edge Service, Accessory Service, Printer, 3 Year

PX65 6-INCH FEATURE OVERVIEW

Rewinder + Label Taken Sensor - 2.36" LCD with Keypad - Thermal Transfer - WiFi (NA)

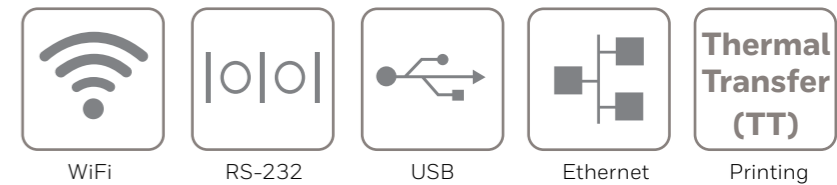

PX65 - 2.36" LCD with Keypad - WiFi (NA) - Internal Rewind + Label Taken Sensor - Thermal Transfer - 203 DPI

PX65A01000010201

PX65, 2.36" LCD with Keypad, Ethernet, WiFi Rest of World (NA) IEEE 802.11 a/b/g/n/ac, Rotating Hanger, Rewinder + Label Taken Sensor, Real Time Clock (RTC), Thermal Transfer (TT), 203 DPI, US Power Cord

Included in the box:

- PX65
- PX65 Regulatory Sheet (PX45-65-ML-RS)
- Ribbon Core (061605-001)
- Batch Plate (1-040253-11)

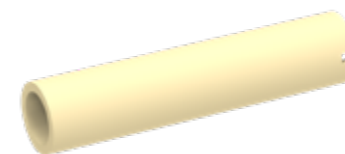

- US Power Cord

Note: Not all printer combinations are available in every region. Check your local Price Book to see which part numbers are available for sale.

Honeywell Repair Services

SVCPX65-SG3N

PX65, Edge Service, Gold Maintenance Contract, 3 Year, New Contract

ADD SVCPRINTHEAD-PRN3

AddOn, Edge Service, Printhead Refresh Service, 203 or 300 DPI, 3-Year Contract

ADD SVCACC-PRN3

AddOn, Edge Service, Accessory Service, Printer, 3 Year

PX65 CONFIGURATION MAP

Industrial Printer

VERSION	STANDARD	CONNECTIVITY	I/O OPTION 1	I/O OPTION 2	MEDIA OPTIONS	MEDIA HANDLING	PRINT OPTION	POWER CORD	DESCRIPTION	NOTES
PX65										
A									Standard	1 x USB A Port (USB 2.0 Host), 1 x USB B Port (USB 2.0 Device), 1 x DB9F (RS-232, up to 115.2 KB/s), Real Time Clock (RTC)
	0								Standard	
		0							Ethernet	Ethernet 10/100/1000 Mbps
			1						Ethernet + WLAN North America (NA)	Available as Kit - Part# 50147002-001 WiFi 802.11 a/b/g/n/ac (North America)
				2					Ethernet + WLAN Rest Of World (ROW)	Available as Kit - Part# 50147002-002 WiFi 802.11 a/b/g/n/ac (Rest Of World)
					00				None	
					01				Parallel Interface	Available as Kit - Part# 50147017-001 PARALLEL IEEE 1284 INTERFACE
					EU				UHF RFID Europe (EU) - 869MHz	Available as Kit - Part# 50147012-002 KIT RFID, 869MHz, PX65, EU
					NA				UHF RFID North America (NA) - 915MHz	Available as Kit - Part# 50147011-002 KIT RFID, 915MHz, PX65, North America
					00				None	
					01				Parallel Interface	Available as Kit - Part# 50147017-001 PARALLEL IEEE 1284 INTERFACE
					EU				UHF RFID Europe (EU) - 869MHz	Available as Kit - Part# 50147012-002 KIT RFID, 869MHz, PX65, EU
					NA				UHF RFID North America (NA) - 915MHz	Available as Kit - Part# 50147011-002 KIT RFID, 915MHz, PX65, North America
						0			None	
						1			Rewinder + Label Taken Sensor (LTS)	Factory Option Only - not field installable
						3			Cutter	Available as Kit - Part# 1-041584-900 KIT CUTTER, PX6i + PX6ie + PX65
							0		Rotating Unwinding Media Hanger	
							20		Thermal Transfer (TT) 203 DPI	Available as Kit - Part# 1-040084-900 KIT, PRINTHEAD 203 DPI, PX6i, PX6ie, PX65
							30		Thermal Transfer (TT) 300 DPI	Available as Kit - Part# 1-040085-900 KIT, PRINTHEAD 300 DPI, PX6i, PX6ie, PX65
								0	US & EU Power Cord	AC Power Cord C13 Type Connector
								1	US Power Cord	AC Power Cord C13 Type Connector
								6	India Power Cord	AC Power Cord C13 Type Connector



HONEYWELL EDGE SERVICES

PX45 / PX65 – Repair Services

Honeywell Edge Services give you the confidence of having leading-class technologies combined with service and support plans that are designed to keep you operational for longer.

Gold Repair Services – 3 Year

The most flexible contract in the industry. The Edge Services Gold Support contract allows you to select the right coverage for your organization, including 5-Day Depot Repairs and:

Service Overview

- Repair or replacement of damaged components, wear and tear, and accidental damage.
- Flexibility to add any Add-On Service

PART NUMBER	DESCRIPTION
SVCPX45-SG3N	PX45, Edge Service, GOLD Maintenance Contract, 5 Day Turnaround, 3 Year , New Contract
SVCPX65-SG3N	PX65, Edge Service, GOLD Maintenance Contract, 5 Day Turnaround, 3 Year , New Contract

Add-On Accessory Replacement Service

Provides replacement cables, interface cards or platen rollers should they be damaged or stop working.

ADD SVCACC-PRN3	AddOn, Edge Service, Accessory Service , Printer, 3 Year
------------------------	---

Add-On Printhead Refresh Service

Provides replacement 203 or 300 DPI printhead at 18 months after purchase.

ADD SVCPRINTHEAD-PRN3	AddOn, Edge Service, Printhead Refresh Service, 200 or 300 dpi, 3 Year , 1 replacement printhead
------------------------------	---

Add-On Device Replacement Service

Replacement devices should a device be damaged beyond repair.

ADD SVCREPLACE-PRN3	AddOn, Edge Service, Device Replacement, Printer, 3 Year
----------------------------	---

Add-On Cutter Replacement Service

Provides replacement cutters should they be damaged or stop working.

ADD SVCCUTTER2-PRN3	AddOn, Edge Service, Cutter Service for Printers, 3 Year
----------------------------	---

Add-On Spare Management Service

Manages every aspect of your spare pool.

ADD SVCSPAREMGMT-PRN3	AddOn, Edge Service, Advanced Exchange, Printer, 3 Year . Customer owned spare pool, Minimum Purchase required, contact your local Honeywell Service Representative for more information.
------------------------------	--

Add-On 2-Day Turnaround Depot Upgrade

Upgrade your Gold Maintenance Contract from 5-Day to 2-Day turnaround at the repair depot.

ADD SVC2DAYDEPOT-PRN3	AddOn, Edge Service, 2-Day Depot Upgrade, 3-Year Agreement, Requires purchase of a 3 Year Gold Maintenance Contract.
------------------------------	---

Platinum Repair Services – 3 Year

The Edge Services Platinum Support contract is the only total support contract in the industry today offering 2-Day Depot Repairs or Spare Pool Management with 3-year contract, that includes:

Service Overview

- Repair or replacement of damaged components
- SVCREPLACE-PRN3 - Replacement devices should a device be damaged beyond repair
- SVCACC-PRN3 - Accessory replacement service
- SVCPRINTHEAD-PRN3 - Provides replacement 203 or 300 DPI printhead at 18 months after purchase.
- SVCSPAREMGMT-PRN3 - Spare pool management (optional, minimum quantity required)
- SVCCUTTER2-PRN3 - Provides replacement cutters should they be damaged or stop working.
- Telephone-based technical support

PART NUMBER	DESCRIPTION
SVCPX45-SP3N	PX45, Edge Service, PLATINUM, 2 Day Turnaround, 3 Year, New Contract
SVCPX65-SP3N	PX65, Edge Service, PLATINUM, 2 Day Turnaround, 3 Year, New Contract



HONEYWELL EDGE SERVICES

PX45 / PX65 – Repair Services

Honeywell Edge Services give you the confidence of having leading-class technologies combined with service and support plans that are designed to keep you operational for longer.

Gold Repair Services – 5 Year

The most flexible contract in the industry. The Edge Services Gold Support contract allows you to select the right coverage for your organization, including 5-Day Depot Repairs and:

Service Overview

- Repair or replacement of damaged components, wear and tear, and accidental damage.
- Flexibility to add any Add-On Service

PART NUMBER	DESCRIPTION
SVCPX45-SG5N	PX45, Edge Service, GOLD Maintenance Contract, 5 Day Turnaround, 5 Year , New Contract
SVCPX65-SG5N	PX65, Edge Service, GOLD Maintenance Contract, 5 Day Turnaround, 5 Year , New Contract

Add-On Accessory Replacement Service

Provides replacement cables, interface cards or platen rollers should they be damaged or stop working.

ADD SVCACC-PRN5	AddOn, Edge Service, Accessory Service , Printer, 5 Year
------------------------	---

Add-On Printhead Refresh Service

Provides replacement 203 or 300 DPI printhead at 18 and 36 months after purchase.

ADD SVCPRINTHEAD-PRN5	AddOn, Edge Service, Printhead Refresh Service, 200 or 300 dpi, 5 Year , 2 replacement printheads
------------------------------	--

Add-On Device Replacement Service

Replacement devices should a device be damaged beyond repair.

ADD SVCREPLACE-PRN5	AddOn, Edge Service, Device Replacement, Printer, 5 Year
----------------------------	---

Add-On Cutter Replacement Service

Provides replacement cutters should they be damaged or stop working.

ADD SVCCUTTER2-PRN5	AddOn, Edge Service, Cutter Service for Printers, 5 Year
----------------------------	---

Add-On Spare Management Service

Manages every aspect of your spare pool.

ADD SVCSPAREMGMT-PRN5	AddOn, Edge Service, Advanced Exchange, Printer, 5 Year . Customer owned spare pool, Minimum Purchase required, contact your local Honeywell Service Representative for more information.
------------------------------	--

Add-On 2-Day Turnaround Depot Upgrade

Upgrade your Gold Maintenance Contract from 5-Day to 2-Day turnaround at the repair depot.

ADD SVC2DAYDEPOT-PRN5	AddOn, Edge Service, 2-Day Depot Upgrade, 3-Year Agreement, Requires purchase of a 5 Year Gold Maintenance Contract.
------------------------------	---

Platinum Repair Services – 5 Year

The Edge Services Platinum Support contract is the only total support contract in the industry today offering 2-Day Depot Repairs or Spare Pool Management with 5-year contract, that includes:

Service Overview

- Repair or replacement of damaged components
- SVCREPLACE-PRN5 - Replacement devices should a device be damaged beyond repair
- SVCACC-PRN5 - Accessory replacement service
- SVCPRINTHEAD-PRN5 - Provides replacement 203 or 300 DPI printhead at 18 and 36 months after purchase.
- SVCSPAREMGMT-PRN5 - Spare pool management (optional, minimum quantity required)
- SVCCUTTER2-PRN5 - Provides replacement cutters should they be damaged or stop working.
- Telephone-based technical support

PART NUMBER	DESCRIPTION
SVCPX45-SP5N	PX45, Edge Service, PLATINUM, 2 Day Turnaround, 5 Year, New Contract
SVCPX65-SP5N	PX65, Edge Service, PLATINUM, 2 Day Turnaround, 5 Year, New Contract



HONEYWELL REPAIR SERVICES

PX45/ PX65 – Repair Services Coverage

For Best-In-Class Service



PX45



PX65

Warranty Cover Against Product Defect

BASIC Service

Gold Coverage:

- Accidental Damage
- Wear & Tear

Includes Replacement of:

- Platen Roller



Flexible GOLD Add-Ons ordered separately

- SVCACC-PRN3 Accessories
- SVCPRINTHEAD-PRN3 Printhead Replacement
- SVCREPLACE-PRN3 Device Replacement
- SVCCUTTER2-PRN3 Cutter Replacement
- SVCSPAREMGMT-PRN3 Advanced Exchange

GOLD Service

Platinum Coverage

- Printhead Replacement
- Coverage for Cables and Interface Cards
- Cutter Replacement

- Accidental Damage
- Device Replacement
- Wear & Tear



Printhead
(3 Year – 1 replacement printhead)
(5 Year – 2 replacement printheads)



Cutter



I/O Cards

PLATINUM Service

MODEL	COVERAGE	PART NUMBER	DESCRIPTION
PX45	BASIC	SVCPX45-EXW3	PX45, BASIC, 10-15 Day Turnaround, 3 Years (1 Year Factory Warranty + 2 Years Extended)
PX65	BASIC	SVCPX65-EXW3	PX65, BASIC, 10-15 Day Turnaround, 3 Years (1 Year Factory Warranty + 2 Years Extended)
PX45	GOLD	SVCPX45-SG3N	PX45, Edge Service, GOLD Maintenance Contract, 5 Day Turnaround, 3 Year, New Contract
PX65	GOLD	SVCPX65-SG3N	PX65, Edge Service, GOLD Maintenance Contract, 5 Day Turnaround, 3 Year, New Contract
	ADD	SVCACC-PRN3	AddOn, Edge Service, Accessory Service, Printer, 3 Year.
	ADD	SVCPRINTHEAD-PRN3	AddOn, Edge Service, 203 or 300 DPI Printhead Refresh Service, 3-Year Contract, 1 replacement printhead
	ADD	SVCREPLACE-PRN3	AddOn, Edge Service, Device Replacement, Printer, 3 Year
	ADD	SVCCUTTER2-PRN3	AddOn, Edge Service, Cutter Service for Printers, 3-Year
PX45	PLATINUM	SVCPX45-SP3N	PX45, Edge Service, PLATINUM, 2 Day Turnaround, 3 Year, New Contract
PX65	PLATINUM	SVCPX65-SP3N	PX65, Edge Service, PLATINUM, 2 Day Turnaround, 3 Year, New Contract

ACCESSORIES

PX45/ PX65 - I/O Cards

Expand your I/O with additional interface cards.

Warning: The I/O Cards must only be installed by an authorized service technician, as you need to open the printer and physically install the cards in the printer.



PX45 / PX65 has 2 x I/O Expansion Slots



PART NUMBER	DESCRIPTION
50147019-001	UART Industrial Interface Card (DB44 8 digital in/out, 4 analogue relays, DB9 RS-232/422/485 port)



PART NUMBER	DESCRIPTION
50147001-001	Applicator Interface Card The applicator interface supports applicator signals with 8 digital IN ports with optocouplers, 8 digital Out ports with optocouplers, and 4 OUT ports with relays. All signals are available on a DB44 pin socket.



PART NUMBER	DESCRIPTION
50147018-001	KIT, DUART Interface RS232+RS232 (RS-232, RS-422, RS-485, and 20 mA Current Loop)



PART NUMBER	DESCRIPTION
50147017-001	KIT, PARALLEL PORT Use with Part# 1-974022-018 Parallel Cable



PART NUMBER	REGION	DESCRIPTION
50147009-002	North America	KIT RFID, 915MHz, PX45 , North America
50147010-002	EU / ROW	KIT RFID, 869MHz, PX45 , EU
50147011-002	North America	KIT RFID, 915MHz, PX65 , North America
50147012-002	EU / ROW	KIT RFID, 869MHz, PX65 , EU

ACCESSORIES

PX45/ PX65 - WiFi Card

Expand your I/O with additional interface cards.

Warning: The I/O Cards must only be installed by an authorized service technician, as you need to open the printer and physically install the cards in the printer.



PART NUMBER	REGION	DESCRIPTION
50147002-001	North America	WiFi 802.11 a/b/g/n/ac Kit (North America)
50147002-002	EU / Rest Of World	WiFi 802.11 a/b/g/n/ac Kit (Rest Of World)

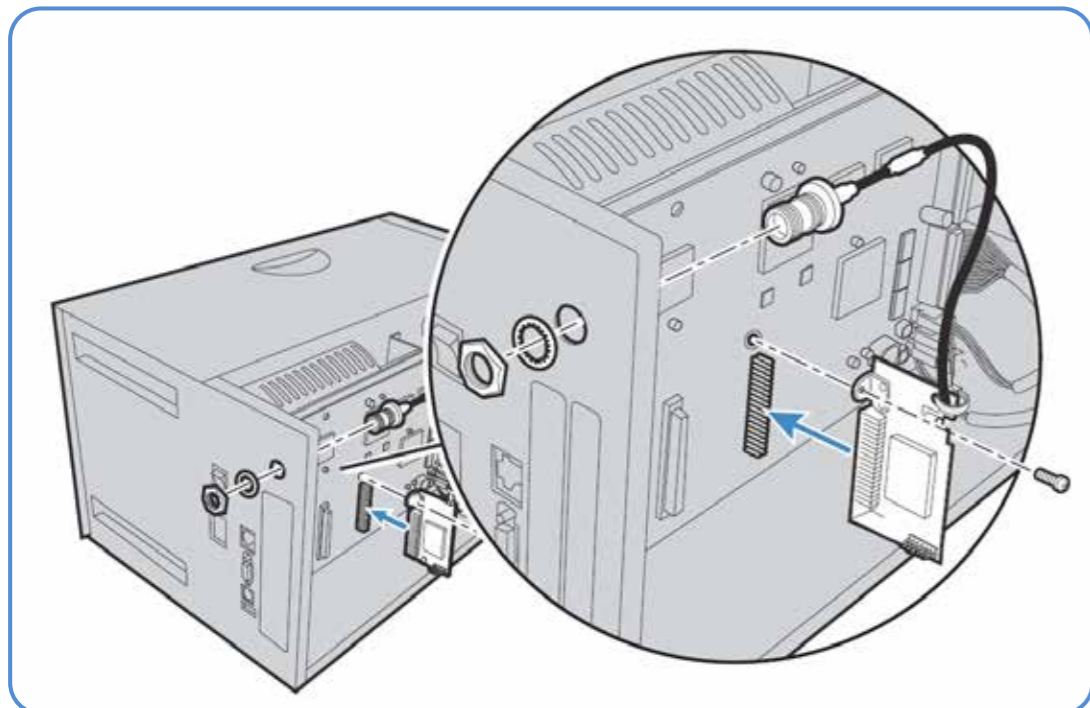
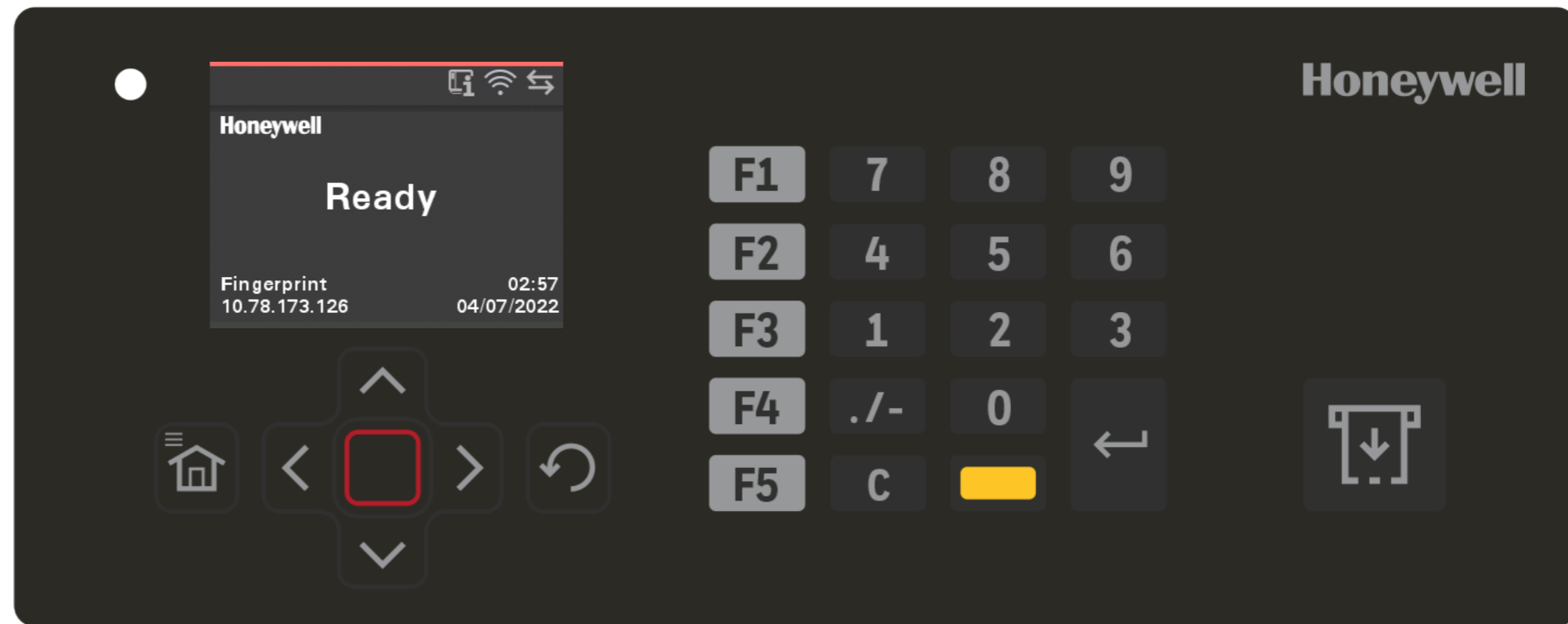

Install WiFi card onto MLB

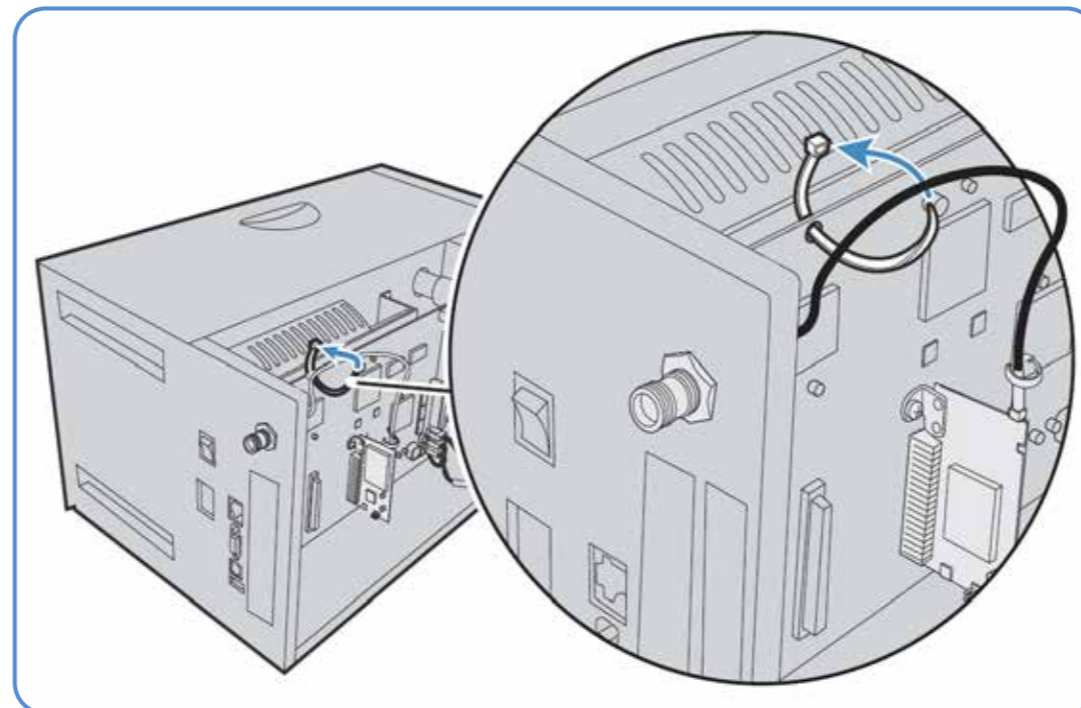

Route antenna cable to back plate



PX45 Rear I/O View

ACCESSORIES

PX45 4-inch Cutter

In cut-off printing, each label is automatically cut from the media roll immediately after the label is printed. You can print on non-adhesive, continuous label stock, and also self-adhesive labels with a liner.



PART NUMBER	DESCRIPTION
1 1-041574-900	KIT CUTTER, PX4i + PX4ie + PX45

PX65 6-inch Cutter

In cut-off printing, each label is automatically cut from the media roll immediately after the label is printed. You can print on non-adhesive, continuous label stock, and also self-adhesive labels with a liner.



PART NUMBER	DESCRIPTION
1 1-041584-900	KIT CUTTER, PX6i + PX6ie + PX65

ACCESSORIES

Consumables and Cables



MODEL	PART NUMBER	DESCRIPTION
PX4ie / PX45	1-040082-900	KIT, PRINthead 203 DPI, PX4i, PX4ie, PX45
PX4ie / PX45	1-040083-900	KIT, PRINthead 300 DPI, PX4i, PX4ie, PX45
PX4ie / PX45	850-812-900	KIT, PRINthead 406 DPI, PX4i, PX4ie, PX45
PX6ie / PX65	1-040084-900	KIT, PRINthead 203 DPI, PX6i, PX6ie, PX65
PX6ie / PX65	1-040085-900	KIT, PRINthead 300 DPI, PX6i, PX6ie, PX65



PART NUMBER	DESCRIPTION
321-576-004	USB (USB-A to USB-B) cable, 6.5 ft. (2 m) length



PART NUMBER	DESCRIPTION
1-974024-018	RS-232 (DB9F to DB9M) cable, 5.9 ft. (1.8 m) length

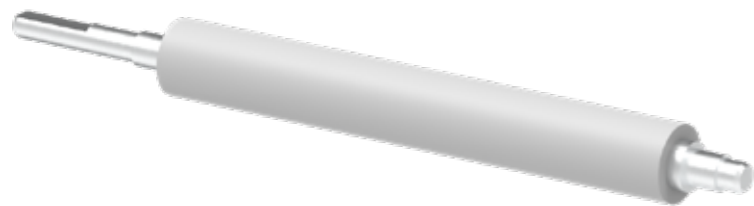

MODEL	PART NUMBER	DESCRIPTION
PX4ie / PX45	1-040230-93	PX4i, PX4ie and PX45, Platen Roller Assembly
PX6ie / PX65	1-010110-90	PX6i, PX6ie and PX65, Platen Roller Assembly



PART NUMBER	DESCRIPTION
1-974022-018	Parallel (IEEE 1284) cable, 5.9 ft. (1.8 m) length



MODEL	PART NUMBER	DESCRIPTION
PX4ie / PX45	1-110501-00	Cleaning Card, 4.5"x6", box of 25
PX6ie / PX65	1-110601-00	Cleaning Card, 6" wide printers, box of 25

MISCELLANEOUS

AC Cords

Regional Power Cords



PX45 Rear I/O View



AC Power - C13 Type Connector

PART NUMBER	TYPE	DESCRIPTION
50117501-001	C13	POWER CORD AUSTRALIA 2500MM,SLED CB
321-501-002	C13	AC Power Cord, Denmark RoHS
77900508E	C13	Cable: power cord, straight, Power cord, Europe EU, IEC320-C13, 2.5 m (8.2 ft)
50131491-001	C13	Cable: power cord, straight - Power cord, India, 1.5 m (5.0 ft)
321-500-002	C13	AC Power Cord, Japan RoHS
9000093CABLE	C13	AC POWER CABLE, C14 TYPE, SWITZERLAND 3-PIN
77900507E	C13	Cable: power cord, straight - Power cord, UK, IEC320-C13, 2.5 m (8.2 ft)
77900506E	C13	Cable: power cord, straight - Power cord, USA, 1.8 m (6.0 ft)

APPENDIX

PX4ie/ PX6ie vs PX45/ PX65 Accessories

ACCESSORIES									
Category	Description	 PX45	 PX65	 PX4ie	 PX6ie	Is the PX45/ PX65 part the same as PX4ie/ PX6ie?	Is the PX4ie/ PX6ie part compatible with PX45/ PX65?	Customer Installable	Notes
Platen Roller	Platen Roller Kit	 1-040230-93	 1-010110-90	 1-040230-93	 1-010110-90	Yes	Yes	Yes	
Printheads	203 DPI Printhead Assembly	1-040082-900	1-040084-900	1-040082-900	1-040084-900	Yes	Yes	Yes	
	300 DPI Printhead Assembly	1-040083-900	1-040085-900	1-040083-900	1-040085-900	Yes	Yes	Yes	
	406 DPI Printhead Assembly	850-812-900	-	850-812-900	-	Yes	Yes	Yes	
WiFi	Kit, Wireless LAN, North America (NA)	50147002-001 (a/b/g/n/ac)	50147002-001 (a/b/g/n/ac)	50147002-001 (a/b/g/n/ac)	50147002-001 (a/b/g/n/ac)	Yes	Yes	No	Upgrade Kit - Requires authorized technician to install
	Kit, Wireless LAN, Rest Of World (ROW)	50147002-002 (a/b/g/n/ac)	50147002-002 (a/b/g/n/ac)	50147002-002 (a/b/g/n/ac)	50147002-002 (a/b/g/n/ac)	Yes	Yes	No	Upgrade Kit - Requires authorized technician to install
RFID	RFID UHF North America (NA)	50147009-002	50147011-002	50147009-001	50147011-001	No	No	No	Upgrade Kit - Requires authorized technician to install
	RFID UHF Europe (EU) / Rest Of World (ROW)	50147010-002	50147012-002	50147010-001	50147012-001	No	No	No	Upgrade Kit - Requires authorized technician to install
Cutter	Cutter Kit	 1-041574-900	 1-041584-900	 1-041574-900	 1-041584-900	Yes	Yes	Yes	
Interface Boards	Applicator	50147001-001	50147001-001	50147001-001	50147001-001	Yes	Yes	No	Upgrade Kit - Requires authorized technician to install
	DUART Industrial Interface Card	50147018-001	50147018-001	50147018-001	50147018-001	Yes	Yes	No	Upgrade Kit - Requires authorized technician to install
	Industrial Interface Board	50147019-001	50147019-001	50147019-001	50147019-001	Yes	Yes	No	Upgrade Kit - Requires authorized technician to install
	Parallel Port Card	50147017-001	50147017-001	50147017-001	50147017-001	Yes	Yes	No	Upgrade Kit - Requires authorized technician to install

APPENDIX

PX Keyboards – Compare PX4i, PX4ie and PX45

Compare the previous IPL and Fingerprint keyboards to the new PX45 keyboard layout.

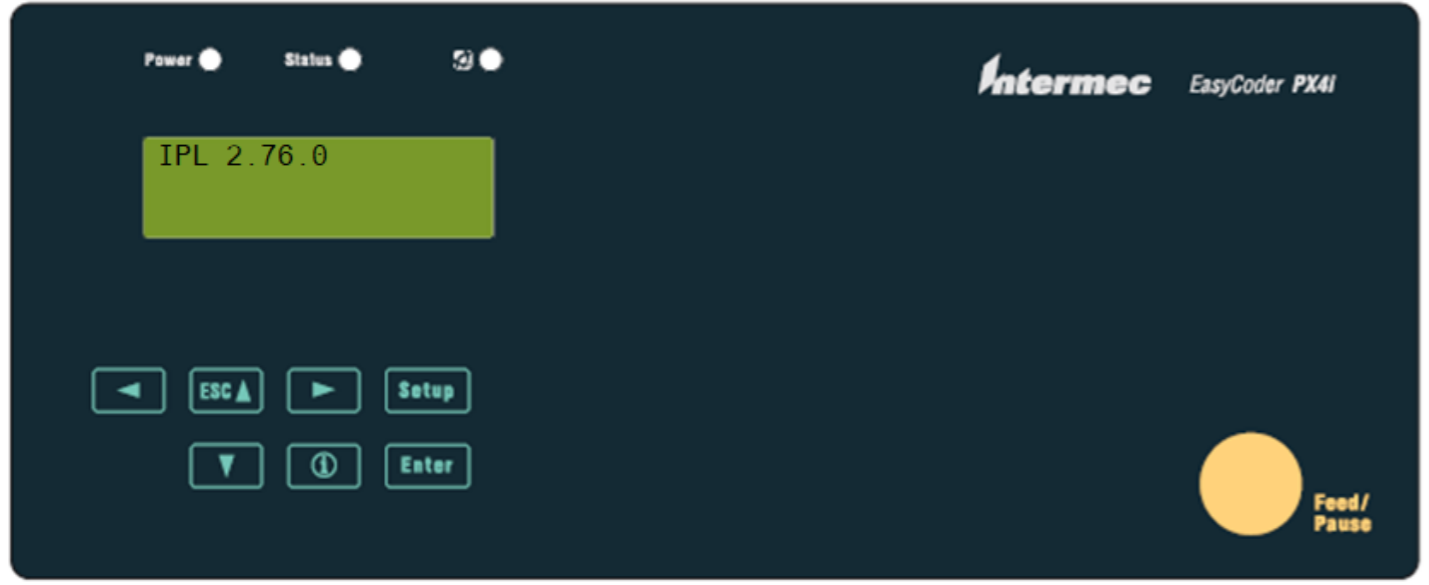

PX4A / PX4B - IPL

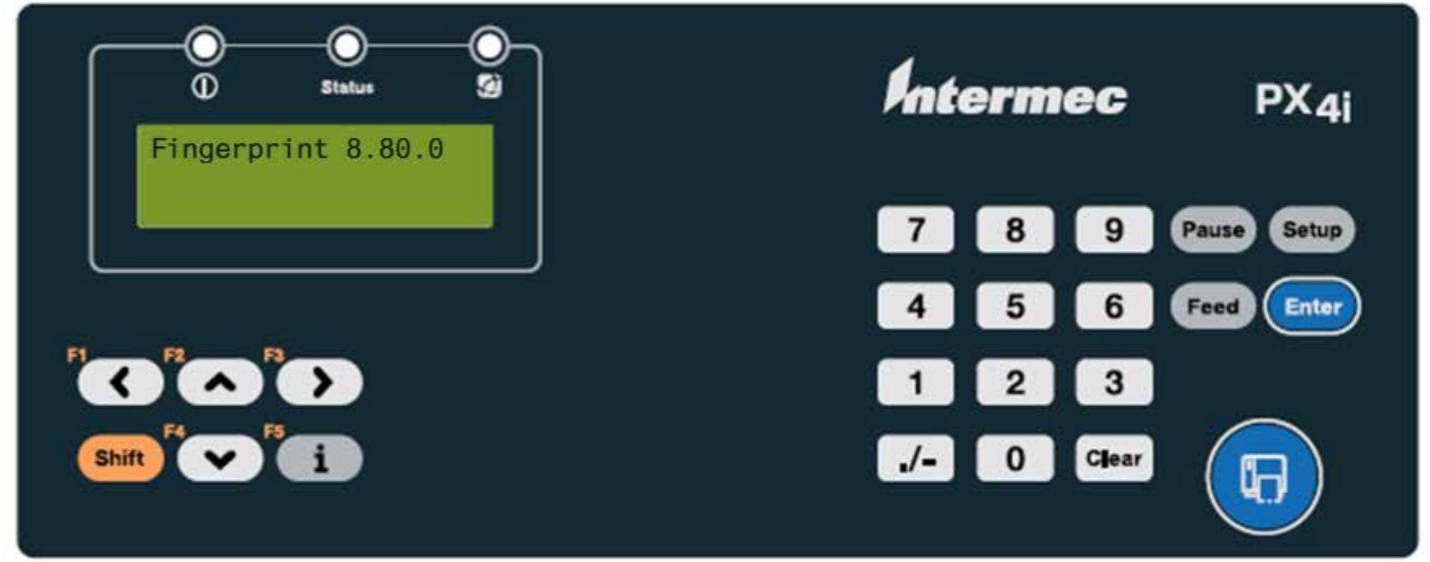

PX4C – Multi-Firmware



PX4A / PX4B - Fingerprint

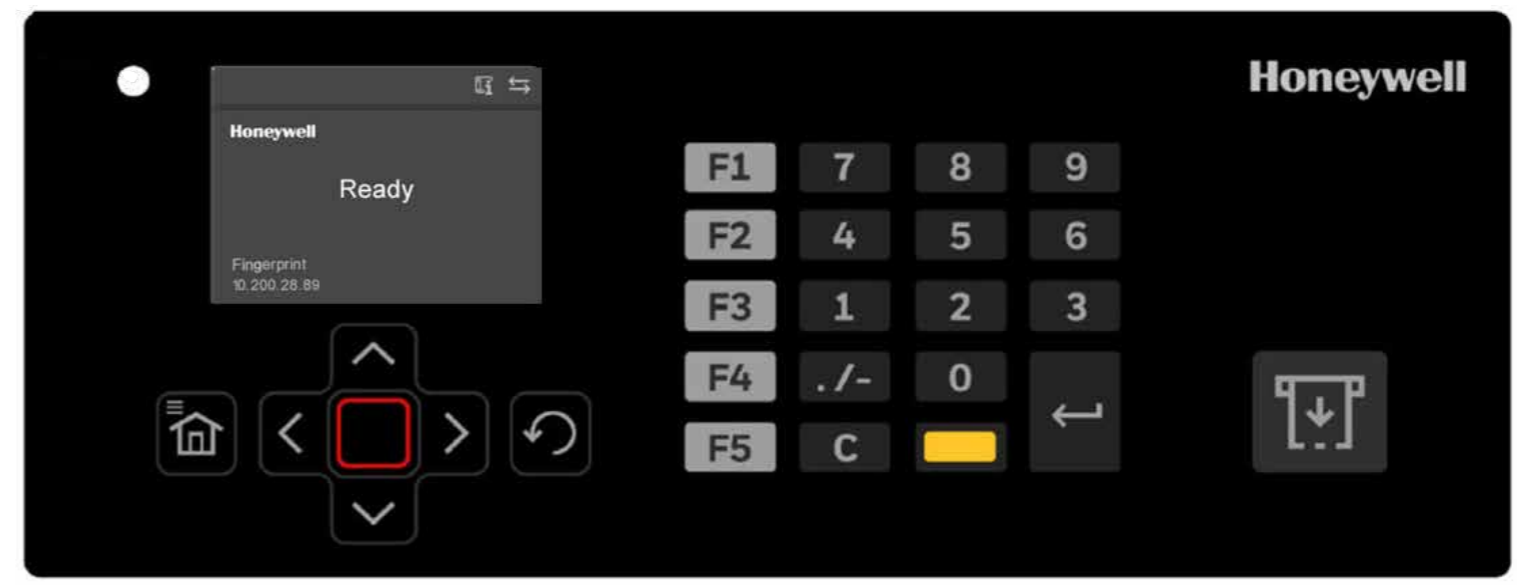

PX4E / PX45 – Multi-Firmware

APPENDIX

PX Connectivity - Compare PX4i, PX4ie and PX45

Compare the previous communications ports.



PART NUMBER DESCRIPTION

PX4A/B/C	270-162-001	PX4, PX6, Legacy, Wireless Interface, IEEE 802.11 b/g North America Only
PX4A/B/C	270-162-002	PX4, PX6, Legacy, Wireless Interface, IEEE 802.11 b/g Rest Of World (ROW)

PART NUMBER DESCRIPTION

PX4E/PX45/PX6E/PX65	50147002-001	KIT Wireless LAN, IEEE 802.11 a/b/g/n/ac (North America)
PX4E/PX45/PX6E/PX65	50147002-002	KIT Wireless LAN IEEE 802.11 a/b/g/n/ac (Rest Of World)

APPENDIX

PX Media Compartment – Compare PX4 to PX4ie/ PX45

Compare the media compartment.

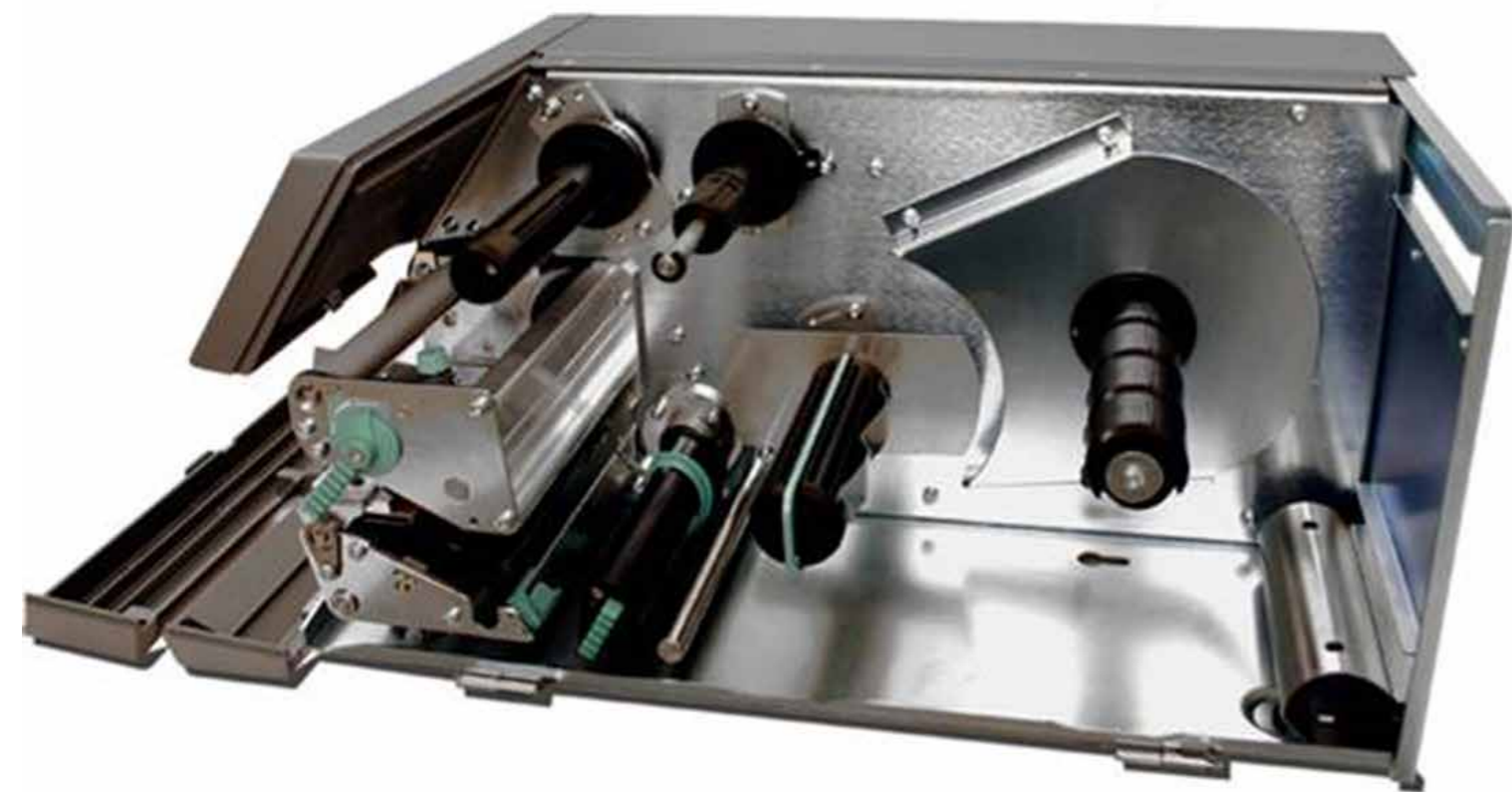

PX4A / PX4B / PX4C



PX4E / PX45

MISCELLANEOUS

Disclaimer

Disclaimer

Honeywell International Inc. ("HII") reserves the right to make changes in specification and other information contained in this document without prior notice, and the reader should in all cases consult HII to determine whether any such changes have been made. The information in this publication does not represent a commitment on the part of HII.

HII shall not be liable for technical or editorial errors or omissions contained herein; nor for incidental or consequential damages resulting the furnishing, performance, or use of this material.

This document contains proprietary information that is protected by copyright. All rights are reserved. No part of this document may be photocopied, reproduced, or translated into another language with-out prior written consent of HII.

Web Address: www.honeywellaidc.com

The Bluetooth trademarks are owned by Bluetooth SIG, Inc., U.S.A and licensed to Honeywell.

Other product names mentioned in the manual may be trademarks of registered trademarks of their respective companies and are the property of their respective owners.

All rights reserved.

For more information

sps.honeywell.com

Honeywell Safety and Productivity Solutions

300 S Tryon St Suite 500
Charlotte, NC 28202
800-582-4263
www.honeywell.com