



EV2360-BK

Your advantages

5
YEAR WARRANTY

The all-round monitor for the office. The monitor's viewing angle, contrast ratio and brightness help deliver superb ergonomics for everyday use in the office. The clear display with an aspect ratio of 16:10 and a resolution of 1920 x 1200 pixels boosts work productivity. Visual elements and colours are displayed crisply and clearly. The EV2360's optional Auto EcoView function automatically adjusts the screen's brightness. This reduces energy consumption and lowers CO2 emissions from power generation. As an added bonus, having the right brightness levels helps prevent distracting glare. This way, both the user and the environment benefit. The EV2360 is targeted at companies, government agencies and home users who are looking for a high-quality monitor.

- ✓ 22.5" LCD monitor with a 16:10 aspect ratio and IPS technology for outstanding image quality
- ✓ Bezel only 1 mm: amazingly compact and ultra-elegant design
- ✓ Flicker-free image reproduction thanks to hybrid brightness control
- ✓ Auto EcoView and EcoView Optimizer deliver maximum power savings and superb ergonomics
- ✓ Optimised antireflection properties and flexible positioning
- ✓ USB 3.1 hub with one upstream and two downstream ports
- ✓ DisplayPort, HDMI and DSub signal inputs
- ✓ Proven to be environmentally friendly and produced in a socially responsible way

Features

Ultra-slim. Ultra-smooth!

Whether it's in sophisticated black or pristine, eye-grabbing white: The ultra-thin design with its bezel of only 1 mm is truly impressive. A thin black glass frame with a width of just 5.4 mm is all that separates the display and bezel from one another on both sides and the top. The side profile and the back of the monitor also have a slimline, delicate appearance. The monitor is really something to behold, giving you plenty of space for your imagination.



Controls integrated into bezel

Electrostatic switches are integrated into the front of the EV2360-BK instead of mechanical buttons. This ensures ease of use while also giving the monitor an extremely elegant look. The speakers and all the controls are also built into the bezel, pointing forward in the direction of the user. They are fully integrated into the monitor's flat, nearly frameless design to offer an excellent user experience.

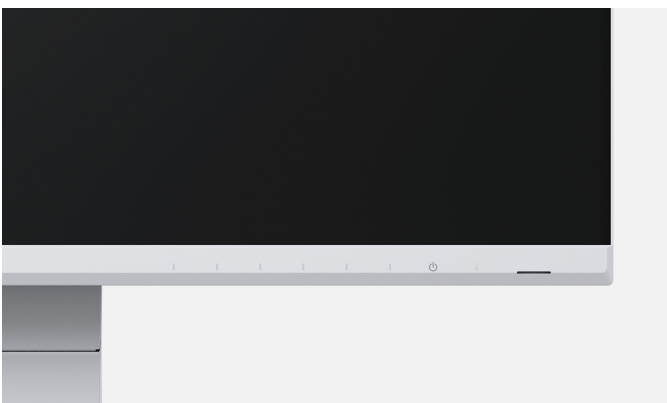

Maximum image quality thanks to the IPS panel

The monitor is capable of all three key elements of excellent image quality: excellent resolution of 1920 x 1200 pixels, maximum contrast of 1000:1, and stable brightness of up to 250 cd/m². That means you will experience razor-sharp text contours, brilliant graphics, and clear images. Thanks to the high-quality IPS panels with LED backlight, contrasts and colours remain stable from every viewing angle.

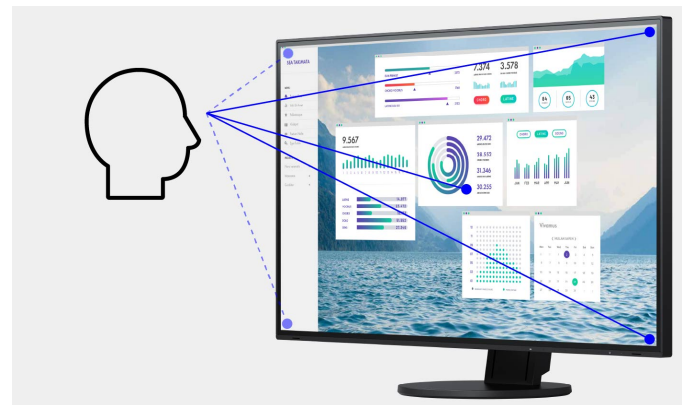

Overdrive to quickly change images

Fast, faster, overdrive. The overdrive function accelerates switching time so that the grey-to-grey change takes only 5 ms on average. You can watch films and rapidly changing images without annoying afterglow.



Without overdrive: streaking and time delay

Features

Precise colour control

An image can only be perfect if the colours are, too. This is why EIZO office monitors have a 10-bit look-up table at a minimum, which allows the colour information to be assigned much more precisely than with conventional 8-bit LUTs. The finest colour gradations ensure that gradients are always perfectly displayed, while also offering customised adjustment options. For example, you can adjust the white balance from 4000 K to 10000 K in 500-K intervals.

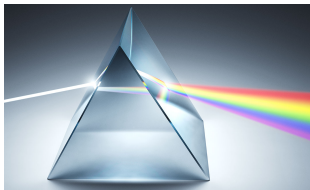

Look-Up-Table with 10 and more bit

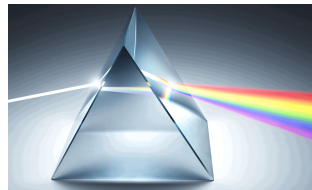

Look-Up-Table with 8 bit

Save electricity and your eyes with Auto EcoView

At day, at night, bright, dark: No matter when and how you work, the Auto EcoView function continuously measures changes of the ambient light and optimises the monitor with ideal brightness values automatically by using a sensor. The benefits: Annoying glare is reduced, your eyes will not get tired as quickly. A special two-point control takes into account the brightest and darkest environment over the course of the day with the respectively desired screen brightness. Another advantage: Thanks to the automatic brightness adjustment, you will save up to 50% of your electricity costs in comparison to a monitor that is permanently operated at maximum brightness.

Of course, you can also continue to configure the monitor manually. EcoView Index is used for orientation on how environmentally friendly and economical your settings are.



During the day

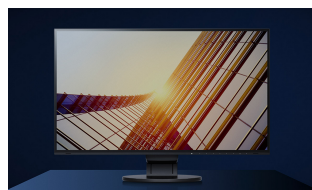

In the evening

Flicker free: for the sake of the eyes

To help protect your eyes, EIZO has developed a hybrid technology to control the backlight. This combines the benefits of the otherwise standard PWM (pulse width modulation) and DC (direct current) control. The PWM control uses much higher frequencies than standard PWM methods. The result: a flicker-free viewing experience. Flickering is reduced down to absolute freedom from flickering, without impairing image quality or colour stability. In addition, the brightness can be set to less than 1% of the maximum value in darkly lit rooms. The benefit: Your screen remains free from glare even under these conditions.

EIZO FlexScan monitors are certified by TÜV Rheinland as flicker-free, emitting low quantities of blue light.

[Why do we experience eye fatigue when using a computer? EIZO has the answers.](#)

Anti-glare coating: more image, less reflection

The EV2360-BK offers a perfect, non-glare surface. By minimising glare by diffusing the reflected light, the EV2360-BK effectively protects your eyes from straining. This keeps your eyes from getting as tired and allows you to sit comfortably in front of the screen, without having to sit in a forced position to prevent glare.

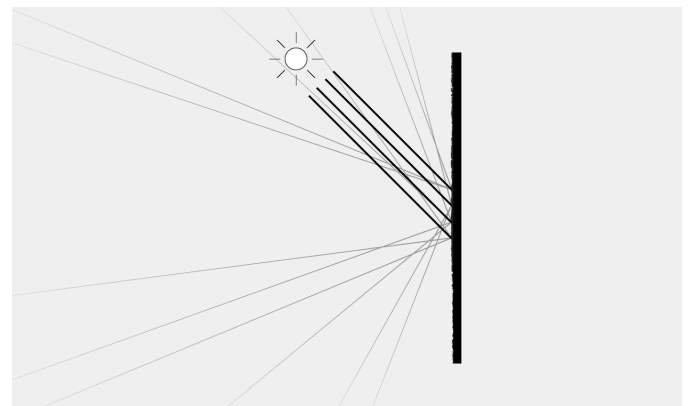

Features

Flexible base

Ergonomic and stable: the adjustable stand focuses on ergonomics. You can rotate, swivel and tilt the monitor stand until you find the most comfortable setting for your back, neck and sitting posture. It features continuous height adjustment and can be lowered almost to the base plate of the stand, enabling you to position the top image line ergonomically right below your eye level.

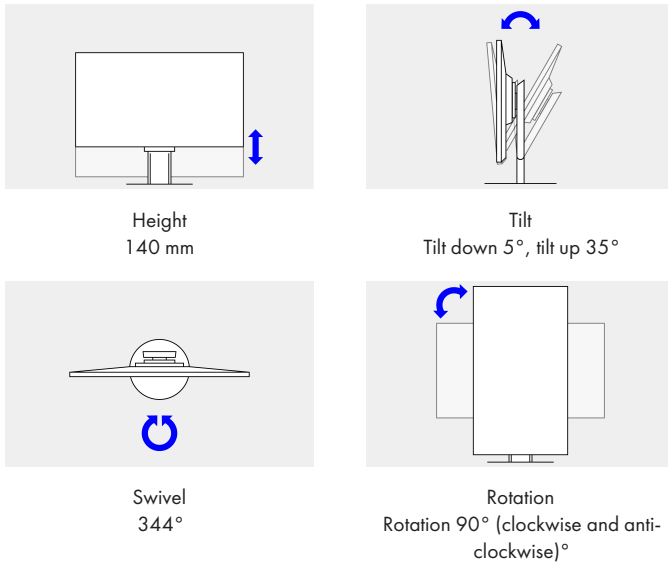

One monitor, many ports

It doesn't get simpler than this: Most end devices, such as PCs, laptops and cameras, can be connected directly to the monitor, thanks to its wide range of signal interfaces. The screen also features two USB type A 3.1 ports. This allows different devices such as mice, keyboards and headphones to be connected. This makes your everyday work easier and guarantees a tidy desk.



Preset colour modes: Optimised display at the press of a button

Preset colour modes make it easier for you to work and view images, texts and videos. This is because when choosing colour settings, it makes a difference whether you are looking at a film, editing an image, surfing the Internet or writing texts. You can configure the respective default settings for brightness, gamma correction and colour temperature at the press of a button. For example, paper mode simulates the pleasant contrast of books by reducing the blue light portion and brightness. This reduces wear on your eyes when reading documents and prevents tiredness.

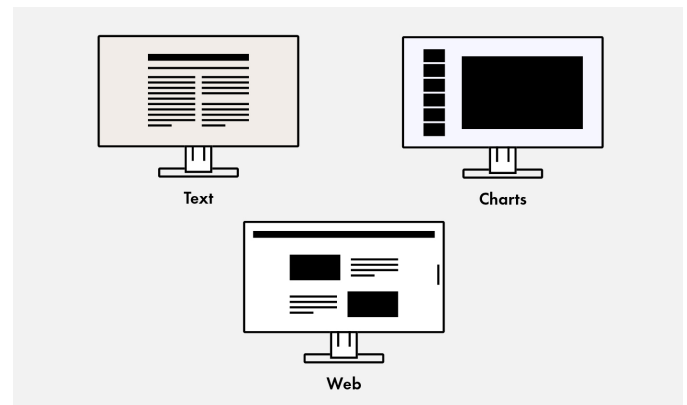

Operation made easy thanks to the Button Guide

The Button Guide provides all functions at a glance. Touching the button is enough and the screen will show all functions and the corresponding control panel.

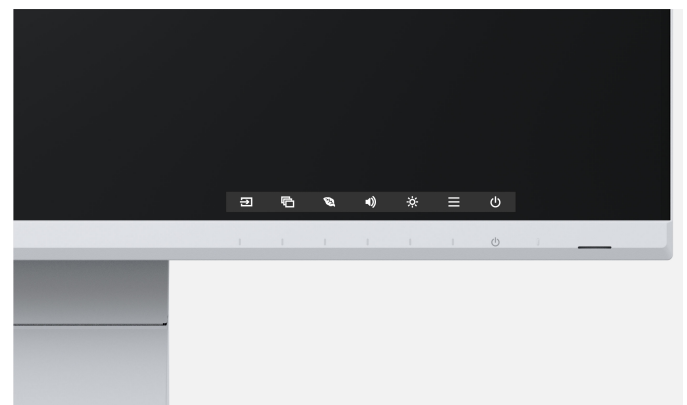

Features

Screen InStyle

In addition to the on-screen menu, you can conveniently control the EV2360-BK by using the Screen InStyle software on a Windows PC. The configuration options include colour reproduction, energy saving options, and ergonomic functions that allow you to reduce the blue light portion (Circadian Dimming). The Screen InStyle software allows the user to apply the settings to all connected screens when using a multi-screen system.

[More about Screen InStyle](#)

Screen InStyle Server is a server application that allows system administrators to centrally manage and control monitors on which Screen InStyle is installed and which are connected to the network. This optimises power consumption and simplifies monitor asset management.

[More about Screen InStyle Server](#)

Monitor Configurator for cross-network settings

Reduced workload for network administrators: The software allows you to configure multiple monitors uniformly in a single step – via a USB connection. This saves you time and ensures you have the same settings on all screens. The configuration can be saved as an XML file and transferred to clients.

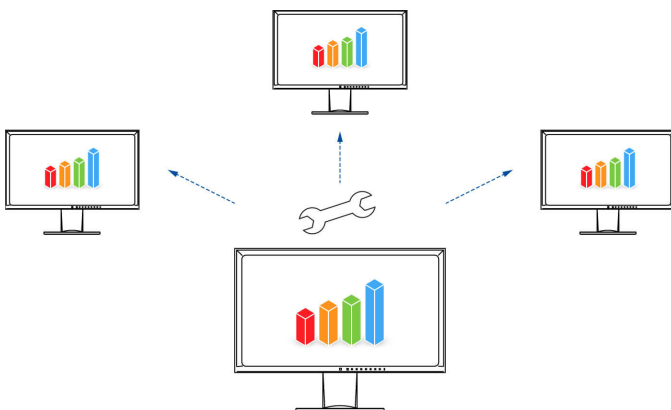

Save up to 30% of energy with the EcoView Optimizer

Save electricity without compromising quality: The EcoView Optimizer reduces the background lighting fully automatically for dark images. This reduces electricity consumption by up to

30%. At the same time, the signal is amplified and the colour tone values adjusted. The result: You will enjoy the image quality you are used to but consume less power.



Zero-watt consumption thanks to the power switch

The monitors have an integrated mechanical power switch, which is extremely practical and energy-saving: If you switch off the monitor using the power switch, the device will stop consuming any power at all. Moreover, it consumes a maximum of 0.5 watt in standby mode.

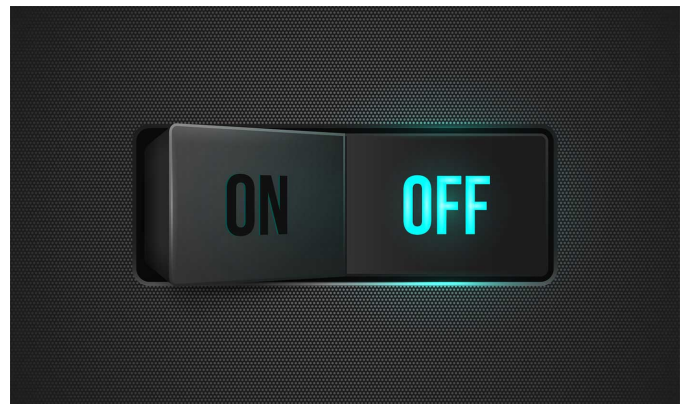

Environmentally and socially conscious production

EIZO uses the EV2360-BK to showcase how image and product quality go hand in hand with responsible planning, material procurement and production. This intrinsic value enables you to make a safe investment in a modern and reliable monitor.

Features

Socially responsible production

The EV2360-BK is produced in a socially responsible way. It is free of child labour and forced labour. Suppliers along the supply chain have been carefully selected and they have also committed themselves to produce in a socially responsible way. This applies in particular to conflict minerals. We present a detailed report about our social responsibility annually and voluntarily.

[Read more about our corporate social responsibility](#)



Sustainable and durable

The EV2360-BK is designed for a long service life that takes into account the entire lifecycle and impact on the environment. It is generally well above the five-year guarantee. Spare parts are available up to five years after the end of production. The monitor's long service life and the ability to repair it save resources and the climate. When designing the EV2360-BK we paid attention to reducing resource consumption by using high-quality components and materials and being meticulous in production. The packaging of the EV2360-BK consists of a cardboard box made of 85% recycled paper, while the transport padding is even 100% recycled plastic.



Environmentally and climate friendly

Each EV2360-BK is manufactured in our own factory, which implements an environmental management system in accordance with ISO 14001. This includes measures to reduce waste, wastewater and emissions, resource and energy consumption, as well as to encourage environmentally conscious behaviour among employees. We publicly report on these measures on an annual basis as a main component of our CSR report.



Five-year warranty

EIZO grants a five-year warranty. This is possible thanks to the highly developed production process based on a simple principle of success: sophisticated and innovative monitor technology, made from high-end materials.



Features

Compliance with standards and guidelines

The monitor is certified according to important and all-encompassing sustainability standards such as TCO Certified Generation 8, EPEAT and Energy Star. The EV2360-BK is a safe investment, when taking into account issues such as ESG (Environmental, social and corporate governance) or SDG (Sustainable Development Goals) from the United Nations and following the necessary guidelines.

Examples of compliance at EIZO include:

- ✓ Safe use of chemicals in cable insulation
- ✓ Comprehensive information transparency after servicing for the entire product lifecycle
- ✓ Safe management of chemicals throughout the entire production process.
- ✓ Appropriate work time management for employees.
- ✓ Anti-corruption management system
- ✓ Responsible procurement of minerals
- ✓ Disclosure of information on energy management

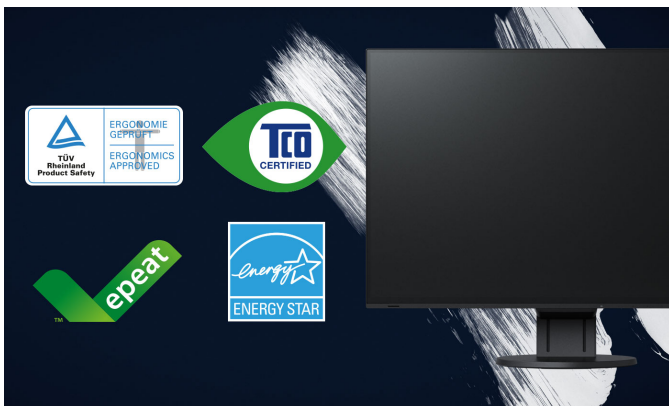

Specification

General

Item no.	EV2360-BK
Case colors	Black
Areas of application	Office, Gaming
Product line	FlexScan
EAN	4995047055198
Variants	EV2360-WT (Colour: White)

Display

Screen size [in inches]	22.5
Screen size [in cm]	57.2
Format	16:10
Viewable image size (width x height)	488.2 x 297.2
Ideal and recommended resolution	1920 x 1200
Pixel pitch [mm]	0.254 x 0.248
Pixel density [ppi]	101
Resolution supported	1920 x 1200, 1920 x 1080 (Full HD), 1680 x 1050, 1280 x 1024, 1024 x 768, 800 x 600, 720 x 400, 640 x 480
Panel technology	IPS
Max. viewing angle horizontal	178 °
Max. viewing angle vertical	178 °
Number of colours or greyscale	16.7 million colours (display port, 8 Bit), 16.7 million colours (HDMI, 8 Bit), 16.7 million colours (DVI, 8 Bit), 16.7 million colours (Dsub, 8 Bit)
Colour palette/look-up table	1.06 billion colour tones / 10 Bit
Max. colour space (typical)	sRGB
Max. brightness (typical) [in cd/m ²]	250
Max. dark room contrast (typical)	1000:1
Typical response time [grey/grey alternation]	5 ms
Max. refresh rate [in hertz]	60
Backlight	LED

Features & control

Preset colour/greyscale modes	sRGB, Paper, Movie, DICOM, 2x free modes for user selection
DICOM tone curve	✓
RadiCS application classes	VIII
Auto EcoView	✓
EcoView Index	✓
EcoView Optimizer	✓
Overdrive	✓
No flickering thanks to hybrid controls	✓
Signal range amplifier (HDMI)	✓
HDCP Decoder	✓
Input signal identification	✓
Built-in speakers	✓
OSD language	de, en, fr, es, it, se, ja, zh
Adjustment options	Brightness, Contrast, Gamma, All EcoView functions, Colour saturation, Colour temperature, Colour Mode, Colour tone, Signal input, Overdrive, Resolution, Audio source, OSD language, Interpolation, Volume
Button Guide	✓
Integrated power unit	✓

Ports

Signal inputs	DisplayPort, HDMI, Dsub
USB specification	USB 3.1 Gen 1
USB upstream ports	1 x type B
USB downstream ports	2 x type A
Video signal	DisplayPort, HDMI (YUV, RGB), RGB Analog
Sync formats	Separate
Audio input	3.5 mm stereo jack, DisplayPort, HDMI
Audio output	3.5 mm stereo jack

Electric data

Frequency	Dsub: 31-75,5 kHz/59-61 Hz; Display Port: 31-75,5 kHz/59-61 Hz; HDMI: 15-75,5 kHz/49-61 Hz, 59-61 Hz
Power consumption (typical) [in watt]	11
Maximum Power Consumption [in watt]	37 (at maximum brightness with all signal inputs and USB ports in use)
Power Save Mode [in watt]	0.5
Power consumption off [in watt]	0
Energieeffizienzklasse	C
Energy consumption/1000h [in kWh]	11
Power supply	AC 100-120 V / 200-240 V, 50/60 Hz

Dimensions & weights

Dimensions [mm]	499 x 334-474 x 233
Weight [in kilograms]	5.5
Dimensions without stand [mm]	499 x 321 x 54
Weight without stand [in kilograms]	3.4
Swivel	344 °
Incline forward/backward	5 ° / 35 °
Pivot	✓ 90° (clockwise and anti-clockwise)
Height adjustment range [mm]	140
Hole spacing	VESA standard 100 x 100 mm

Certification & standards

Certification	CE, CB, TCO certified 8.0, EPA Energy Star, TÜV/GS, TÜV/Ergonomics, TÜV/Blue Low Light Content, TÜV/Flicker Free, EPEAT 2018 (US), cTÜVus, TÜV/S, EAC, BIS, PSE, FCC-B, CAN ICES-3 (B), RCM, VCCI-B, BSMI, CCC, RoHS, China RoHS, WEEE
---------------	--

Software & accessories

Accompanying software and other accessories are available for download	Screen InStyle
Additional supply	Manual via download, Power cord, Signal cable DisplayPort - DisplayPort, USB 3.0 cable, Quick guide
Accessories	EIZO ScreenCleaner (for the best possible clean without scratching the monitor), HH200PR-K (HDMI (High Definition Multimedia Interface) cable), PM200-K (DisplayPort cable to transfer digital video and audio signals.), PCSK-03R-BK (Thin Client Mount for the EIZO FlexStand 3R stand), CP200-BK (USB-C to DisplayPort cable, 200 m)

Warranty

Warranty and service	5 years warranty*
----------------------	-------------------

Terms

*) Maximum of 30,000 hours of operation from the date of purchase. **) Zero pixel error guarantee for completely lit sub-pixels (partial pixels ISO 9241-307). Valid: six months from the purchase date.