

48.120

Viewgo monitor arm - desk 120

More comfort and space: two things this entry-level ergonomic monitor arm helps to create. Position your monitor above your desk, at a spot that's just right for you, to free up valuable desk space. Slender yet strong, this monitor arm combines a striking design with a tough steel construction.

- Static height adjustment range of 210 mm
- Independent depth adjustment
- Fitted with cable clips to guide cables tidily
- Main components made of steel
- VESA MIS-D 75 x 75/100 x 100 mm compatible
- Rotate 360°, tilt +90°/-50°, swivel 360°
- Weight capacity max. 8 kg per monitor
- Comes with a desk clamp mount and bolt-through desk mount
- Suitable for desktop thicknesses of 5 up to 40 (clamp) or 60 mm (bolt through)
- Monitor size limit: height 900 mm
- Simple height adjustment using a tightening knob
- Installs firmly on any surface without a scratch thanks to protective non-slip foam layer
- Hassle-free installation using just one supplied tool

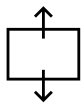
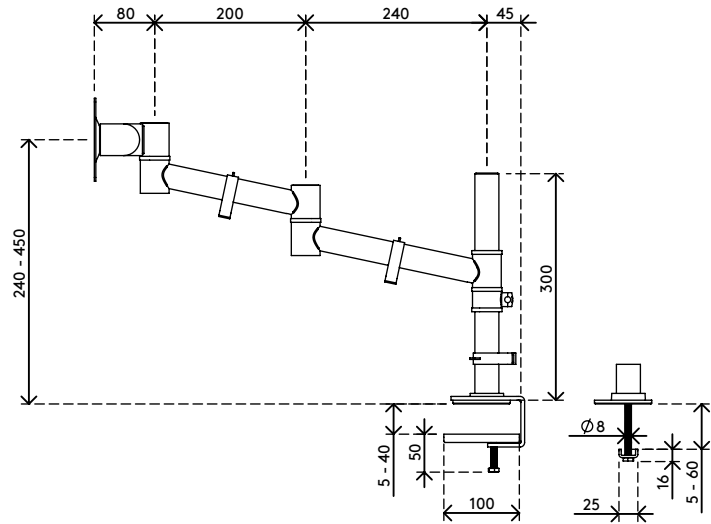
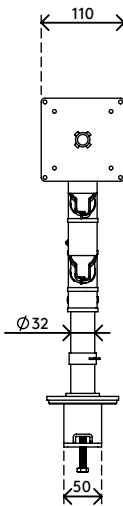
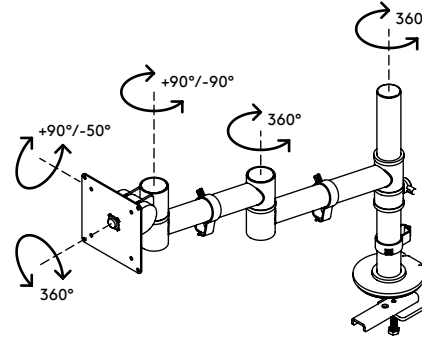
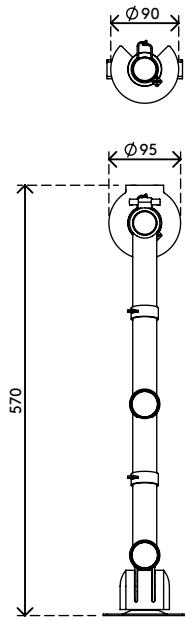

210 mm (8,3")



+90°/-50°



+90°/-90°



360°

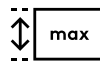

900 mm (35,4")



75 x 75/100 x 100



8 kg

Viewgo monitor arm - desk 120

2015/10/05

48.120

 615 x 182 x 155 mm

 pcs

 white

 3,3 kg

 805410481209