

48.840







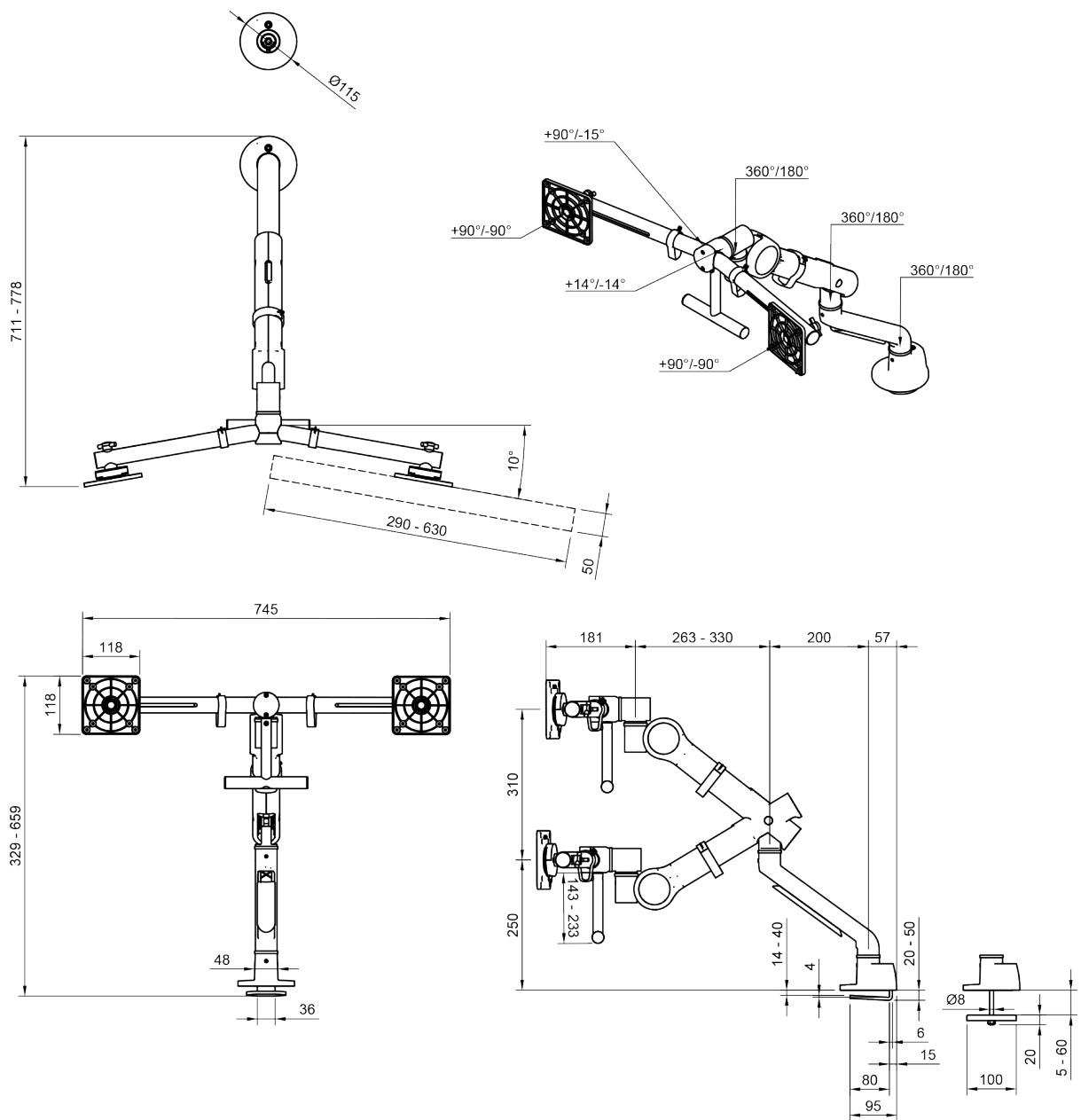

# Viewgo pro monitor arm HD - desk 840

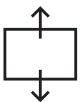
Elevate your workspace with the Viewgo pro HD dual ergonomic monitor arm. Great for larger and heavier dual monitor set-ups. Enhance employee productivity and comfort, while reclaiming precious desk real estate and fostering a clutter-free environment. The Viewgo pro not only conforms to all ergonomic requirements but also boasts an elegant design, all at a compelling price point. Installation is a piece of cake, and its versatile top-access clamp ensures compatibility with nearly all types of desks.







- Dynamic height adjustment of 310 mm (12,2")
- Depth and height adjustment using a handle
- Independent depth adjustment
- Fitted with a lifetime warranty adjustable tension spring
- Fitted with cable clips to guide cables tidily
- Main components made of aluminium
- Standard VESA quick release
- Compatible with VESA MIS-D 75 x 75/100 x 100 mm
- Monitors: tilt +90°/-15°, swivel +90°/-90°, rotate +90°/-90°
- Arm: swivel 360°
- Swivel lock of arm set to +90°/-90° (can be switched off)
- Weight capacity min. 2 kg - max. 5,5 kg (4,4 - 12,1 lb) per monitor
- Equipped with desk clamp mount (top access clamp) and desk mount
- Suitable for desktop thicknesses from 14 to 40 mm (0,6 - 1,57") (clamp) or 60 mm (2,36") (grommet)
- Maximum monitor size: width 630 mm (24,8") - height 1000 mm (39.4")
- Sturdy, scratch-free attachment to any surface thanks to protective rubber anti-slip coating
- Easy installation with the tools provided
- Supports monitors in portrait and landscape mode
- Unique mechanism in crossbar enables precise horizontal levelling
- Tension gauge ensures easy monitor setup

# viewgo



-   
310 mm (12,2")
-   
+90°/-15°
-   
+90°/-90°
-   
+90°/-90°
-   
630 mm (24,8")
-   
max. 27"
-   
75 x 75/100 x 100 mm  
(3 x 3/3,9x3x9")
-   
(2x) 2 kg - 5,5 kg  
(4,4- 12,1 lb)

**Viewgo pro monitor arm HD - desk 840** 2024/03/25

|   |   |   |
|---|---|---|
|  <b>48.840</b> |  <b>775 x 395 x 140 mm</b> |  <b>1 pcs</b>        |
|  <b>white</b>  |  <b>7,10 kg</b>            |  <b>805410488406</b> |