

58.140

Viewlite monitor arm - desk 140





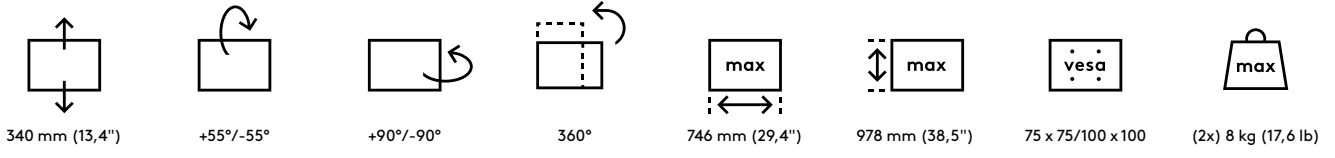
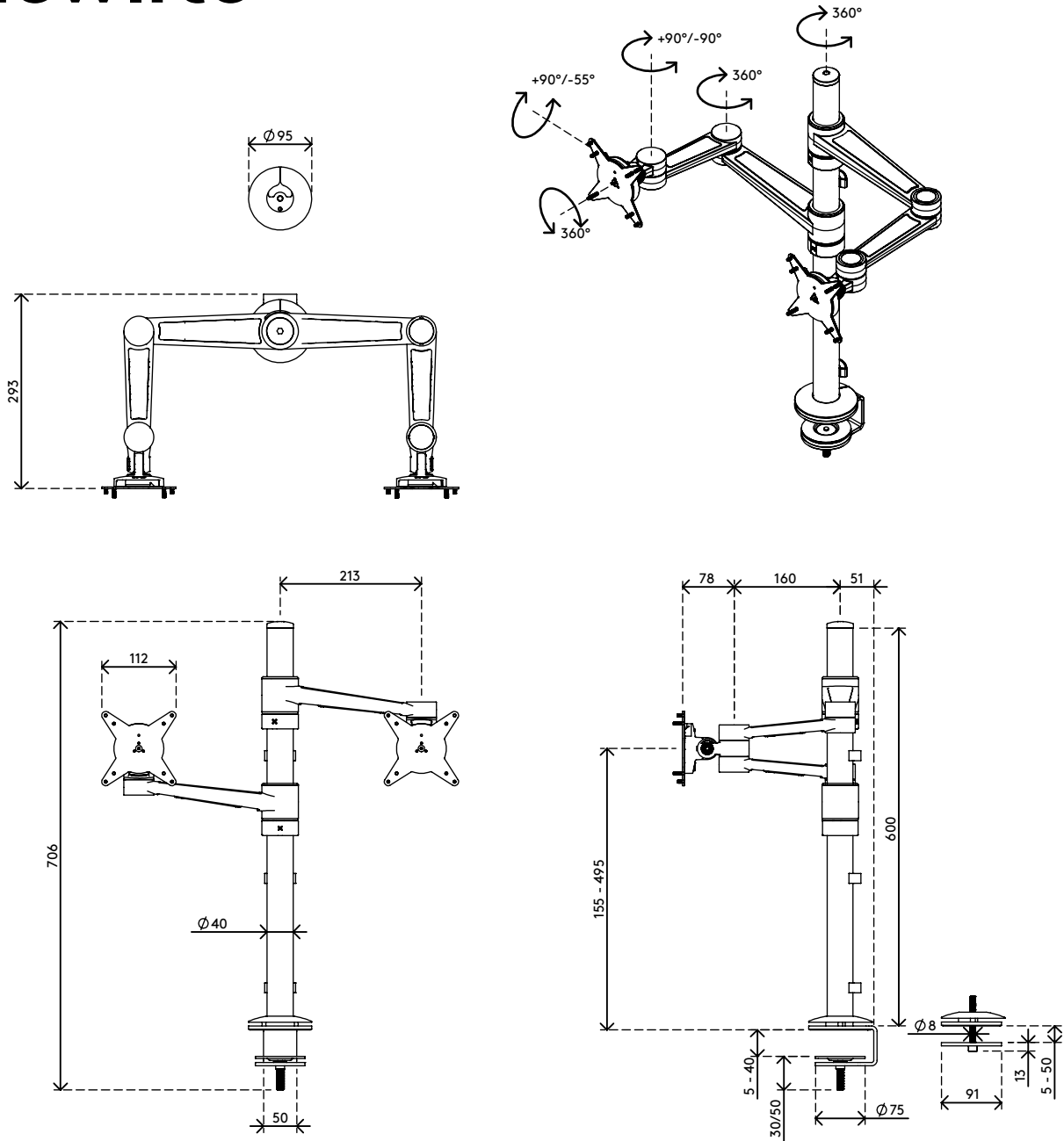

Designed for dual monitor applications. With the arm heights individually adjustable, you can align your monitors perfectly, even if they're different sizes or weights. With its four extensions you can also adjust each monitor independently and even make a face-to-face setup.

- Static height adjustment range of 340 mm (13,4")
- Independent depth adjustment
- Integrated cable management
- Main components made of aluminium
- 40% of aluminium content is already recycled
- VESA MIS-D 75 x 75/100 x 100 mm compatible
- Monitor: tilt +55°/-55°, swivel +90°/-90°, rotate 360°
- Arm: swivel 360°
- Weight capacity max. 8 kg (17,6 lb) per monitor
- Comes with a desk clamp mount and bolt-through desk mount
- Suitable for a desktop thickness of 5 up to 40 mm (0,2" - 1,6") (clamp) or 50 mm (2,0") (bolt through)
- Monitor size limit: width 746 mm (29,4") - height 978 mm (38,5")
- Fitted with a practical quick-release VESA system
- Monitor rotation lock can be enabled

viewlite



Viewlite monitor arm - desk 140 2021/01/05

 58.140	 757 x 286 x 110 mm	 1 pcs
 white	 5,68 kg	 805410581404