



MOMO 4138 Monitor Arm Motion Plus (black)

Key Benefits

- Height Adjustable
- Suitable for one, two or a whole series of monitors
- Easy to assemble without tools
- Flexible modular system
- TÜV certified / 10-year guarantee

The ergonomic monitor arm for every workplace The MOMO 4138 is a dynamic monitor arm specially designed for monitors that are regularly adjusted in height, such as at flexible work stations. The monitor arm can bear screens up to 43 inches weighing up to 10 kg.

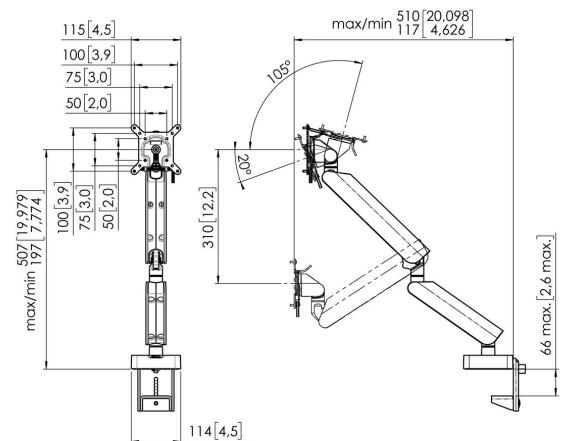



MOMO 4138 Monitor Arm Motion Plus (black)



Specifications

Article number (SKU)	7141380
Colour	Black
EAN single box	8712285353543
TÜV certified	Yes
Tilt	Tilt -20°/+105°
Turn	Up to 180°
Rotate	Up to 180°
Guarantee	10 years
Min. screen size (inch)	10
Max. screen size (inch)	43
Max. height of interface (mm)	115
Max. width of interface (mm)	115
Adjustable depth	True
Adjustable height	True
Max. screen size (inch)	43
Min. weight load (kg)	1
Number of pivot points	3
Universal or fixed hole pattern	Fixed
Awards	iF Product Design Award 2023 Red Dot Product Design Award 2023
Height adjustment	Mechanical spring
Max. center display	507
Mounting Possibilities	On and through desk
Max. thickness desk	iF Product Design Award 2023 Red Dot Product Design Award 2023

VOGEL'S HOLDING BV (©)

All rights reserved.
Subject to printing errors,
technical and price
amendments.

Date: 2023-06-23



Vogel's. For Sure.